

## ADVANCED INSTRUCTIONS

# VHF/UHF TRANSCEIVER **ID-51A** **ID-51E**

Instructions for advanced operations and additional details are described in this manual.  
See the Basic instruction manual to begin D-STAR, especially for new users.

To update the repeater list,  
click here!



## INTRODUCTION

### 1 ACCESSORY ATTACHMENT

### 2 USING A MICROSD CARD

### 3 PANEL DESCRIPTION

### 4 BATTERY CHARGING

### 5 BASIC OPERATION

### 6 BC RADIO OPERATION

### 7 D-STAR INTRODUCTION

### 8 D-STAR OPERATION <BASIC>

### 9 D-STAR OPERATION <ADVANCED>

### 10 GPS/GPS-A OPERATION

### 11 VOICE MEMORY FUNCTION

### 12 MEMORY CHANNEL PROGRAMMING

### 13 SCAN OPERATION

### 14 PRIORITY WATCH

### 15 REPEATER AND DUPLEX OPERATIONS

### 16 MENU SCREEN

### 17 OTHER FUNCTIONS

### 18 OPTIONS

### 19 SPECIFICATIONS

## TROUBLESHOOTING

## INDEX





# INTRODUCTION

## Functions and features of Adobe® Reader®

The following functions and features can be used with Adobe® Reader®.

### • Keyword search

Click “Find (Ctrl+F)” or “Advanced Search (Shift+Ctrl+F)” in the Edit menu to open the search screen. This is convenient when searching for a particular word or phrase in this manual.

\*The menu screen may differ, depending on the Adobe® Reader® version.

Click to open the find or search screen or advanced search screen.

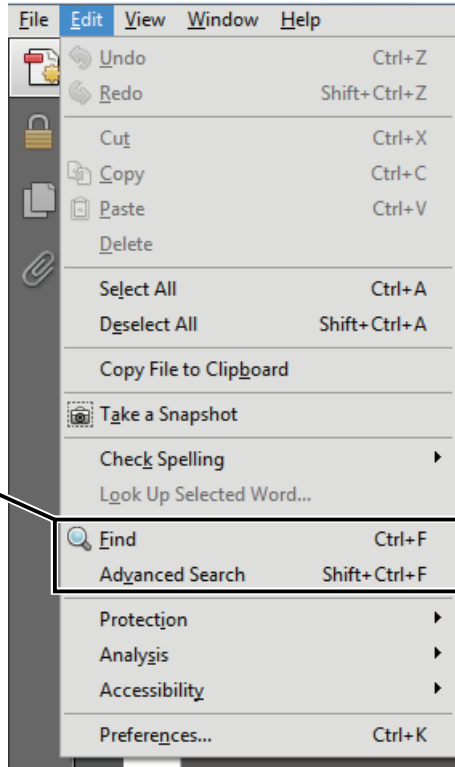

### • Find screen

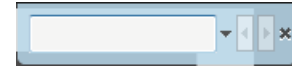

### • Advanced search screen

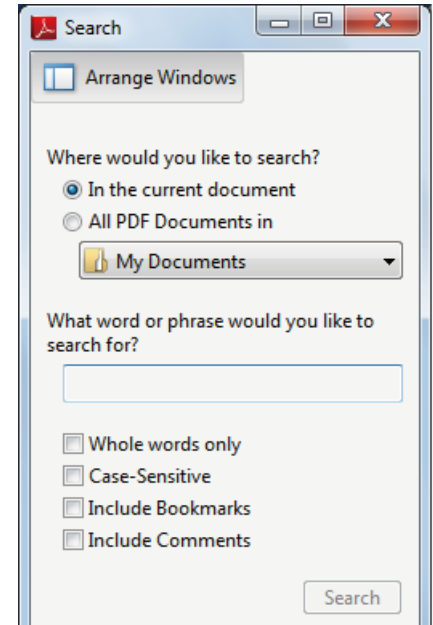

### • Printing out the desired pages.

Click “Print (P)” in File menu, and then select the paper size and page numbers you want to print.

\*The printing setup may differ, depending on the printer. Refer to your printer’s instruction manual for details.

\*Select "A4" size to print out the page in the equalized size.

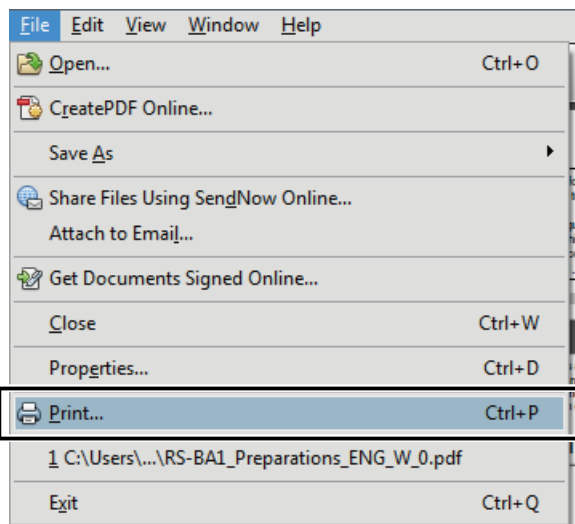

### • Read Out Loud feature.

The Read Out Loud feature reads aloud the text in this Instruction Manual.

Refer to the Adobe® Reader® Help for the details. (This feature may not be usable, depending on your PC environment including the operating system.)

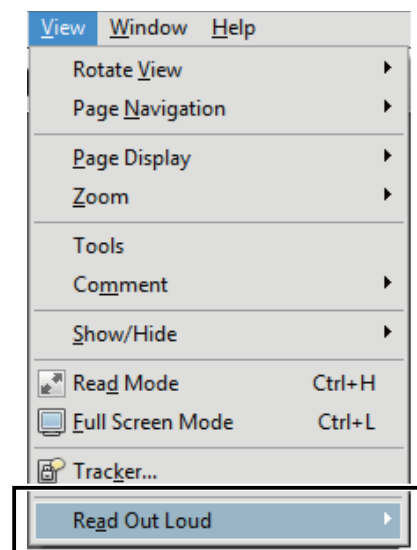

\*The screen may differ, depending on the Adobe® Reader® version.

# Section 1      ACCESSORY ATTACHMENT

---

■ Antenna .....	1-2
■ Battery pack .....	1-2
■ Belt clip .....	1-3
■ Hand strap .....	1-3

## ■ Antenna

Insert the antenna connector into the antenna base and tighten the antenna.

/// **NEVER** carry the transceiver by holding only the antenna.

### ✓ *For your information*

Third-party antennas may increase transceiver performance. An optional AD-92SMA ANTENNA CONNECTOR ADAPTER is available to connect an antenna that has a BNC connector. (p. 18-3)

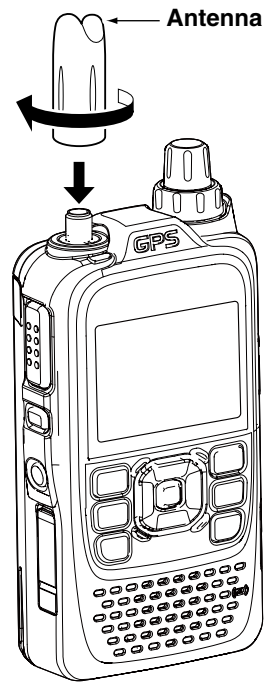

## ■ Battery pack

### *To attach or detach the battery pack:*

Attach or detach the battery pack or battery case, as illustrated to the right.

See page 4-2 for details of the battery pack.

/// Even when the transceiver power is OFF, a small current still flows in the radio. Remove the battery pack or case from the transceiver when not using it for a long time. Otherwise, the battery pack or installed batteries will become exhausted.

/// The battery protection function automatically sets transceiver to Low1 power (0.5 W) when the temperature is around 0°C (+32°F) or below. In this case, transmit power selections (High, Mid and Low2) are disabled.

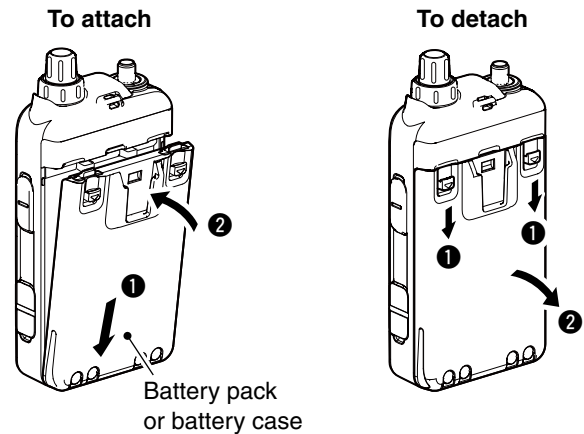

Illustration shows the battery pack is attached.

## ■ Belt clip

### *To attach the belt clip:*

- ① Remove the battery pack from the transceiver, if it is attached. (p. 1-2)
- ② Slide the belt clip in the direction of the arrow until the belt clip locks in place, and makes a 'click' sound.

### *To detach the belt clip:*

- ① Remove the battery pack from the transceiver, if it is attached. (p. 1-2)
- ② Lift the tab up (①), and slide the belt clip in the direction of the arrow (②).

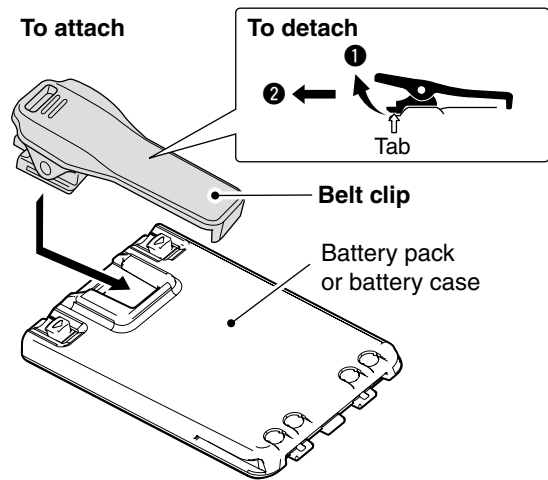

## ■ Hand strap

To facilitate carrying the transceiver, slide the hand strap through the loop on the top of the rear panel, as illustrated to the right.

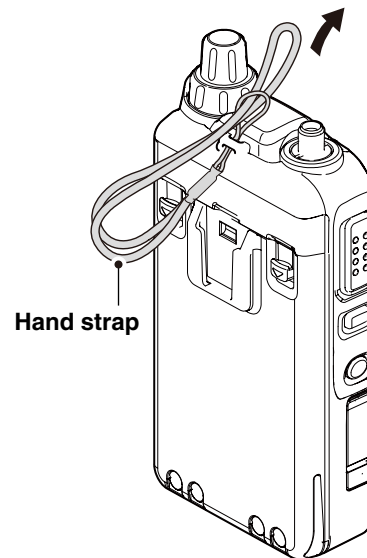

## Section 2

## USING A microSD CARD

---

■ About the microSD card .....	2-2
■ Saving data onto the microSD card.....	2-2
■ Inserting the microSD card.....	2-3
◇ Formatting the microSD card .....	2-3
■ Removing the microSD card.....	2-4
■ Save setting data onto a microSD card .....	2-5
■ Save with a different file name.....	2-7
■ Loading the saved data files that are on the microSD card.....	2-9
■ Backup the data stored on the microSD card onto a PC .....	2-11
◇ About the microSD card's folder composition	2-11
◇ Make a backup file on your PC.....	2-12
■ Updating the repeater list .....	2-13

## ■ About the microSD card

The microSD and microSDHC cards are not available from Icom. Purchase locally.

A microSD card of up to 2 GB or a microSDHC of up to 32 GB, can be used with the ID-51A/E. Icom has checked the operation with the following microSD and microSDHC cards.

(As of November 2012)

Brand	Type	Memory size
SanDisk®	microSD	2 GB
		4 GB
	microSDHC	8 GB
		16 GB
		32 GB

- The above list does not guarantee the card's performance.
- Through the rest of this document, the microSD card and a microSDHC card are simply called microSD cards.
- Icom recommends that you format all microSD cards to be used with the ID-51A/E, even preformatted microSD cards for PCs or other uses.

**NOTE:**

- Read the instructions of the microSD card thoroughly before use.
- **NEVER** remove the microSD card, detach the battery pack/case, or power OFF the transceiver, while reading or writing data to or from the microSD card, or during cloning. It will cause the data to be corrupted or damage the card.
- **NEVER** drop, or apply vibration or impact to the microSD card. This will cause the data to be corrupted or damage the card.
- The microSD card will get warm if used continuously for a long period of time.
- A microSD card has a certain lifetime, so data reading or writing will not be possible when using it over a long time period.
- Icom will not be responsible for any damage caused by data corruption of a microSD card.

## ■ Saving data onto the microSD card

The following data can be stored onto the card:

- **Data settings of the transceiver**  
Memory channel contents, and **repeater** lists stored in the transceiver.
- **Communication contents**  
The transmitted and received audio.
- **Communication log**  
The communication and receive history log.
- **Automatic answering voice audio for the DV mode**  
Voice audio to use with the Auto Reply function in the DV Mode.
- **Voice audio for the Voice TX function**  
Voice audio to use with the Voice TX function.
- **Position data from the GPS receiver**  
Position and time data from a GPS receiver, that is in a log file as a route.
- **Voice Recorder**  
The microphone audio.

## ■ Inserting the microSD card

- ① Turn OFF the transceiver.
- ② Lift OFF the [micro SD] slot cover on the side panel.
- ③ With the terminals facing the front, insert the card into the slot until it locks in place, and makes a 'click' sound.  
**DO NOT** touch the terminals.
- ④ Firmly close the [micro SD] slot cover.

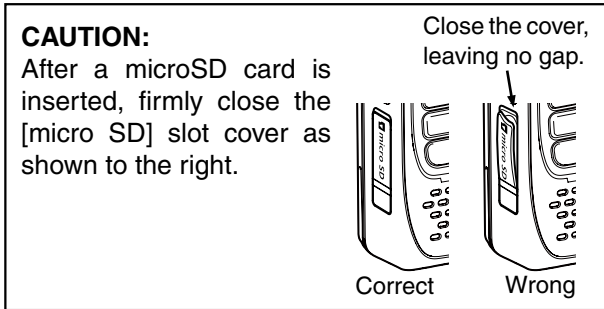

**NEVER** forcibly or inversely insert the card. It will damage the card and/or the slot.

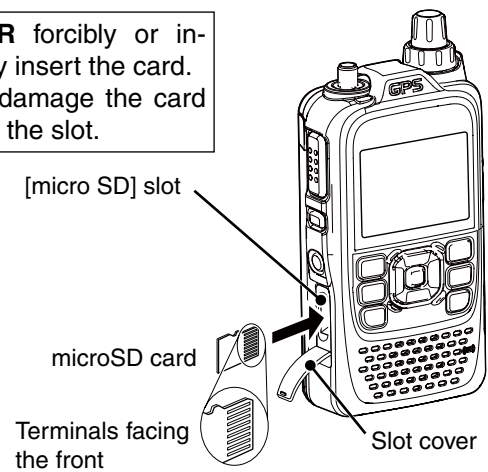

- If you use a brand new microSD card, format the microSD card, by doing the following steps.
- **Formatting a card erases all its data.** Before formatting any programmed card, make a backup file onto your PC.

### ◇ Formatting the microSD card

- ① Turn ON the transceiver.
- ② Push [MENU] .
- ③ Push D-pad(↑) to select the root item ("SD Card"), and then push D-pad(Ent).

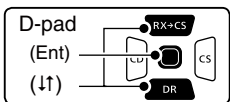

- ④ Push D-pad(↓) to select "Format," and then push D-pad(Ent).
  - The confirmation screen "Format OK?" appears.
- ⑤ Push D-pad(↑) to select "YES," and then push D-pad(Ent) to format.
  - The formatting starts and the display shows the formatting progress.
  - **NEVER** turn OFF the power while formatting.
- ⑥ After formatting, the display automatically returns to the SD CARD menu.
- ⑦ Push [MENU] to exit the MENU screen.

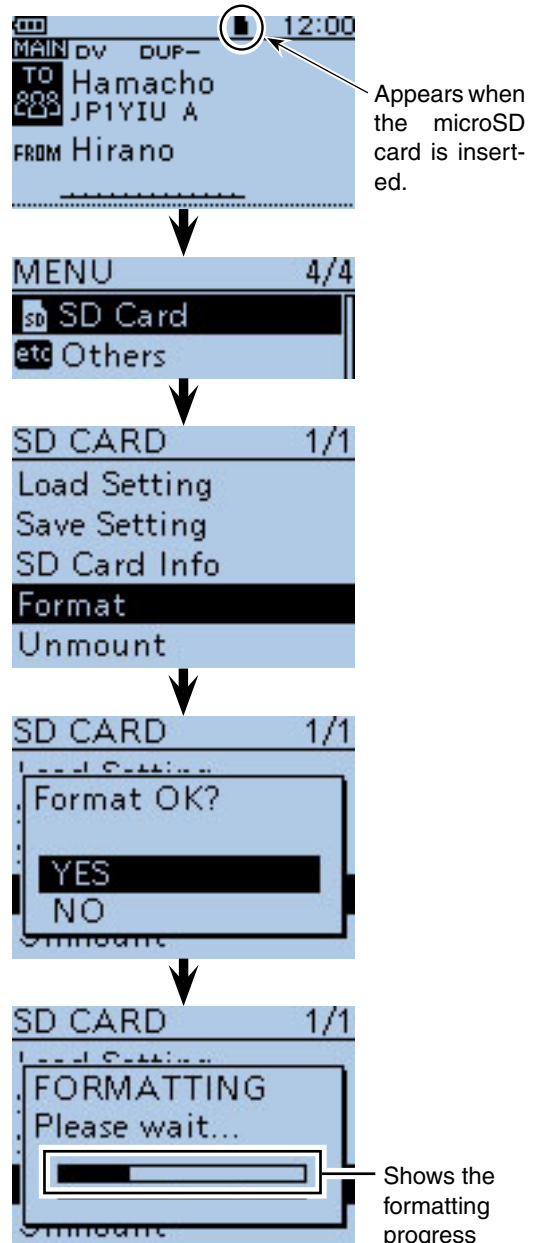
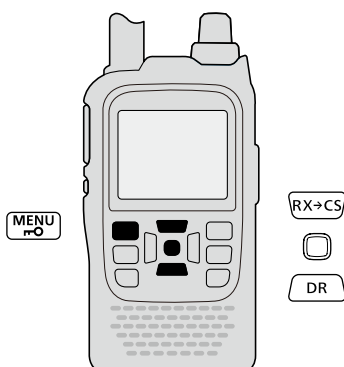

## ■ Removing the microSD card

- ① Turn OFF the power.
- ② Lift OFF the [micro SD] slot cover on the side panel.
- ③ Push in the microSD card until a click sounds, and then carefully pull it out.
  - **DO NOT** touch the terminals.
- ④ Firmly close the [micro SD] slot cover.

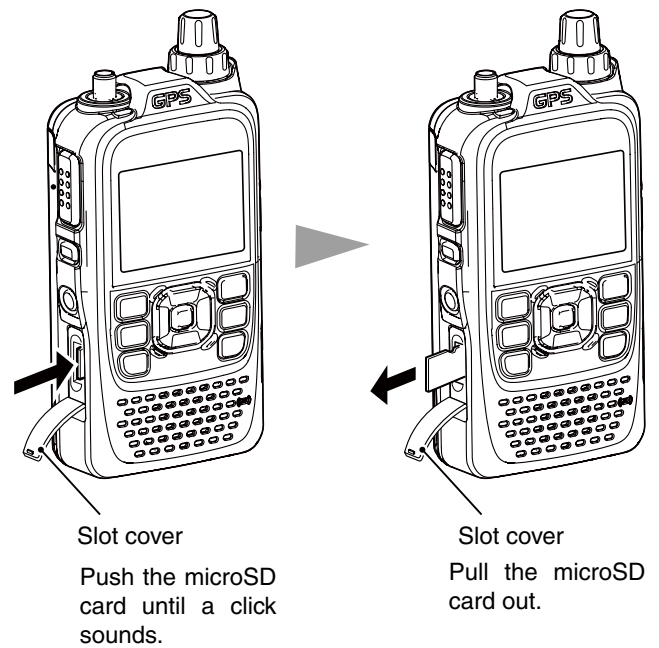
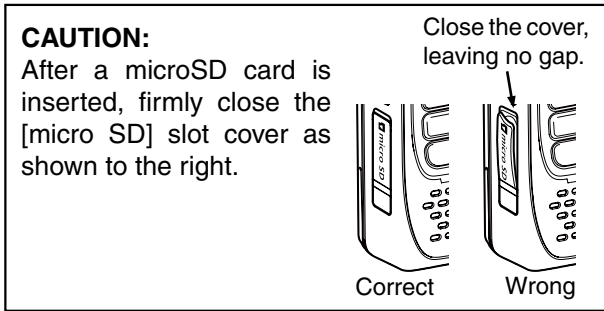

If removing the microSD card while the transceiver's power is ON, by doing the following steps.

- ① Push [MENU] .
- ② Push D-pad(↓) to select the root item ("SD Card"), and then push D-pad(Ent).

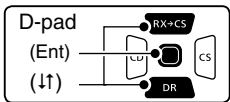

- ③ Push D-pad(↓) to select "Unmount," and then push D-pad(Ent).
  - The confirmation screen "Unmount OK?" appears.
- ④ Push D-pad(→) to select "YES," then push D-pad(Ent) to unmount.
- ⑤ When the unmounting is completed, "Unmount is completed." is displayed, then the screen automatically returns to the SD CARD menu.
- ⑥ Push [MENU] to exit the MENU screen.
- ⑦ Lift OFF the [micro SD] slot cover on the side panel.
- ⑧ Push in the microSD card until a click sounds, and then carefully pull it out.
  - **DO NOT** touch the terminals.
- ⑨ Firmly close the [micro SD] slot cover.

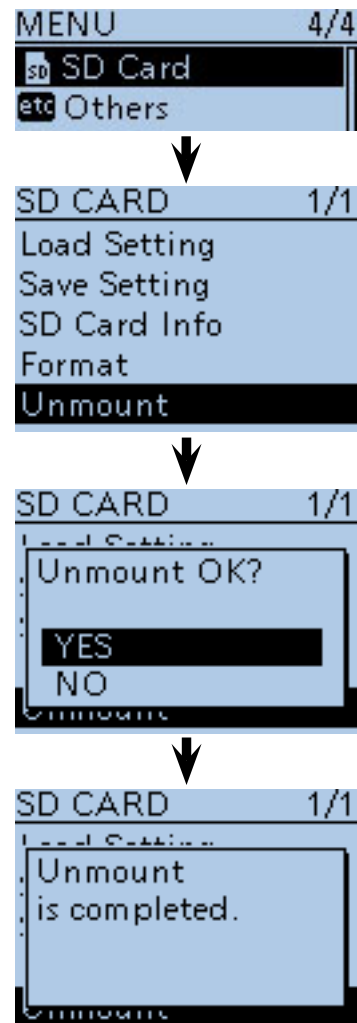
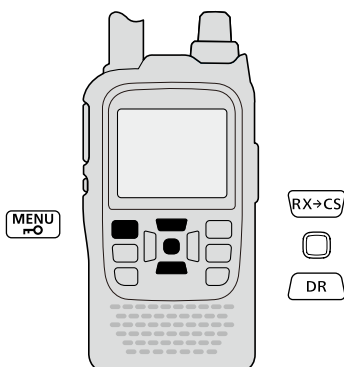



## ■ Save setting data onto a microSD card

Memory channels, item settings in the menu screen, and **repeater** lists can be saved on the microSD card. Saving data settings on the microSD card allows you to easily restore the transceiver to its previous settings, even if an all reset is performed.

### ✓ For your information

Data settings are saved in the “icf” file format that is used in the CS-51 cloning software. The saved data on the microSD card can be copied onto a PC and edited by the cloning software. Data settings can be saved as a new file or to overwrite an older file.

### Saved as a new file

- ① Push [MENU] .
- ② Push D-pad(↑) to select the root item (“SD Card”), and then push D-pad(Ent).

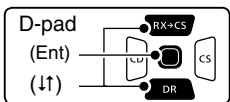

- ③ Push D-pad(↑) to select “Save Setting,” and then push D-pad(Ent).
- ④ Push D-pad(↑) to select “<<New File>>,” and then push D-pad(Ent).
  - The FILE NAME screen is displayed.
  - The file name is automatically named in the following manner; Setyyyyymmdd\_xx (yyyy: Year, mm: month, dd: day, xx: serial number)
  - Example:** If a 2nd file is saved on October 30, 2012, the file is named “Set20121030\_02”.
  - If you want to change the file name, see “Save with a different file name” (p. 2-7).
- ⑤ Push D-pad(Ent) to save the file name.
  - The confirmation screen “Save file?” appears.
- ⑥ Push D-pad(↑) to select “YES,” then push D-pad(Ent) to save.
  - While saving, a progress bar is displayed, then the “SD CARD” screen is displayed after the save is completed.
- ⑦ Push [MENU]  to exit the MENU screen.

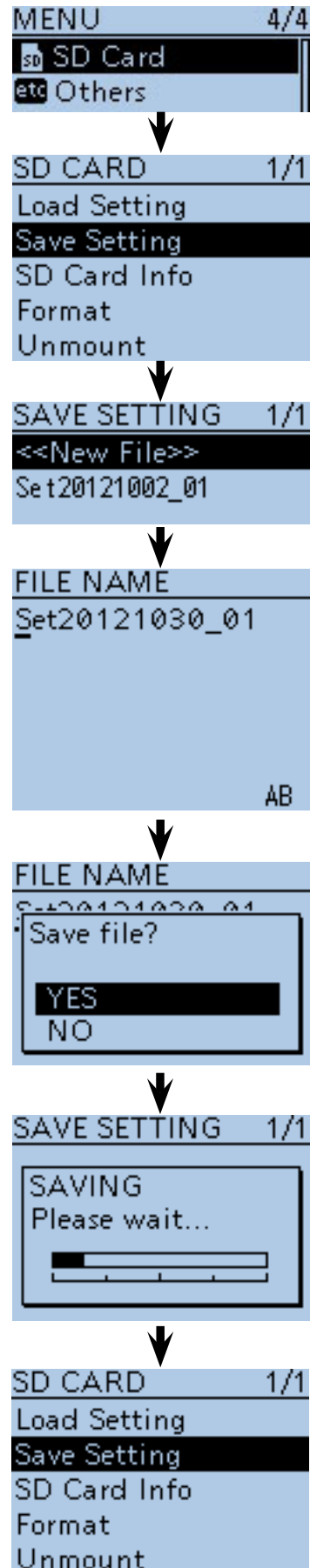
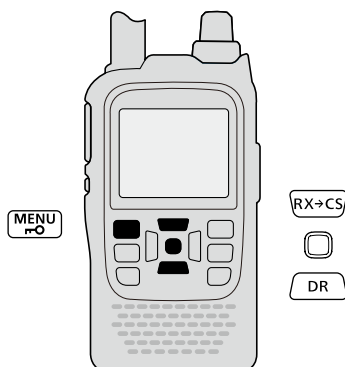

## 2 USING A microSD CARD

### ■ Save setting data onto a microSD card (Continued)

#### Overwriting a file

(Example: Overwriting the “Set20121002\_01”)

- ① Push [MENU] .
- ② Push D-pad(↑) to select the root item (“SD Card”), and then push D-pad(Ent).

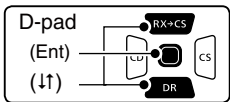



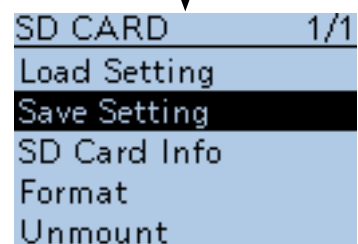
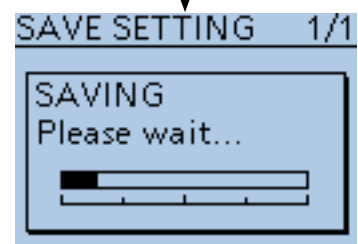
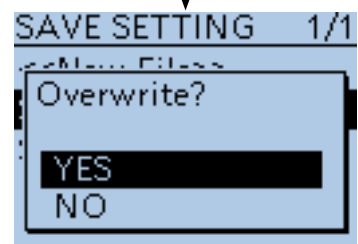
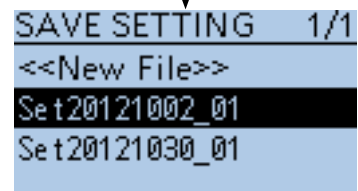
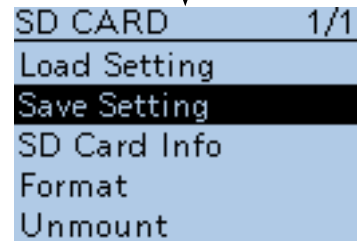
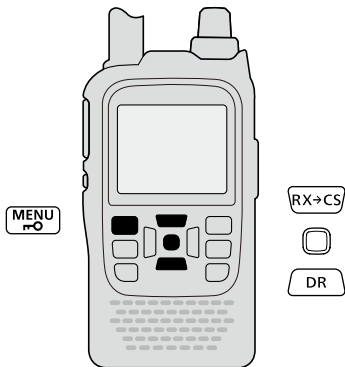

- ③ Push D-pad(↑) to select “Save Setting,” and then push D-pad(Ent).
- ④ Push D-pad(↑) to select the desired file to be overwritten, and then push D-pad(Ent).  
(Example: Selecting “Set20121002\_01”)
  - The confirmation screen “Overwrite?” appears.
- ⑤ Push D-pad(↓) to select “YES,” and then push D-pad(Ent) to overwrite the setting file.
  - While saving, a progress bar is displayed, then the “SD CARD” screen is displayed after the save is completed.
- ⑥ Push [MENU]  to exit the MENU screen.



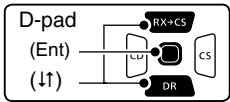

## Save with a different file name

- ① Push [MENU] .
- ② Push D-pad(↑) to select the root item ("SD Card"), and then push D-pad(Ent).



- ③ Push D-pad(↑) to select "Save Setting," and then push D-pad(Ent).
- ④ Push D-pad(↑) to select "<<New File>>," and then push D-pad(Ent).
  - The FILE NAME screen is displayed.
- ⑤ Push [CLR]  to delete the previously programmed character.
  - Push [CLR]  to delete the selected character, symbol or number.
  - When the cursor does not select a character, the previous character is deleted.
  - If  is held down, all the characters are deleted.
- ⑥ Rotate [DIAL] to select a desired character.
  - The selected character blinks.

### About text entry

- Push D-pad(←) to move the cursor backward or forward.
- While selecting a character, push [QUICK]  to change the character to a upper case or lower case letter.
- While selecting a digit, push [QUICK]  to open the input mode selection window.
  - Push D-pad(↑) to select the desired Upper case letters, Lower case letters, Numbers or Symbols.
  - To enter symbols, select "!"#, and then push D-pad(Ent) to open the symbol character selection window. Rotate [DIAL] to select the desired symbol character, and then push D-pad(Ent).
- Move the cursor, then rotate [DIAL] to insert a character.
- A space can be selected in any input mode selected.
- Push D-pad(→) to enter a space.
- If you make a mistake, push [CLR]  to delete the selected character, or hold down [CLR] to continuously erase the characters, first to the right, and then to the left of the cursor.

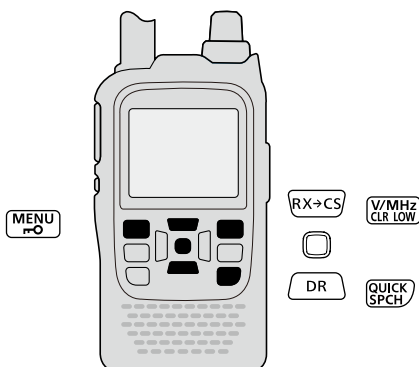

Continued on the next page

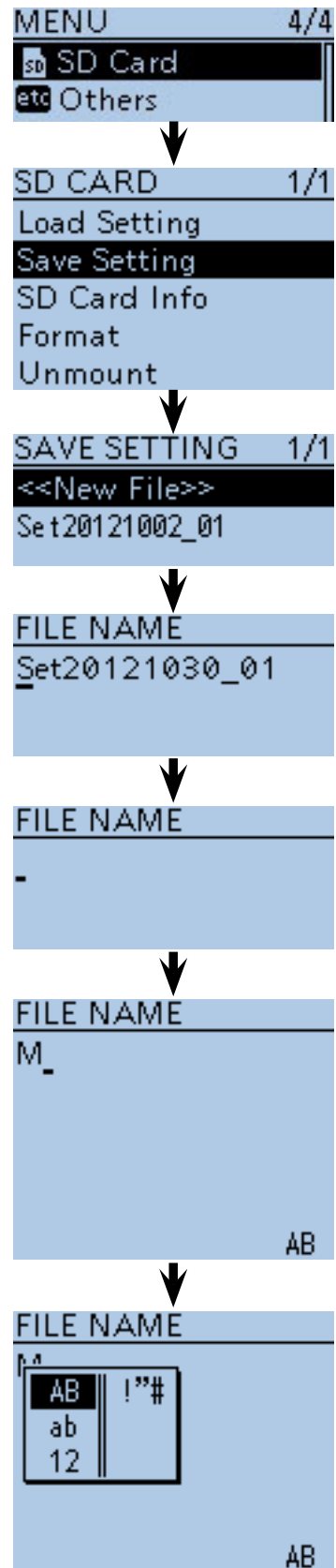



Input mode selection window

## 2 USING A microSD CARD

### ■ Save with a different file name (Continued)

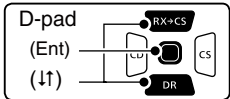
- ⑦ Push D-pad(→) to move the cursor to the second digit.
- ⑧ Repeat steps ⑥ and ⑦ to enter a name of up to 14-characters, including spaces.  
(Example: My Data)
- ⑨ After entering the name, push D-pad(Ent).
  - After pushing D-pad(Ent), “Save file?” appears.



- ⑩ Push D-pad(↑) to select “YES,” and then push D-pad(Ent) to save the setting file.
  - While saving, a progress bar is displayed, then the “SD CARD” screen appears after the save is completed.
- ⑪ Push [MENU]  to exit the MENU screen.

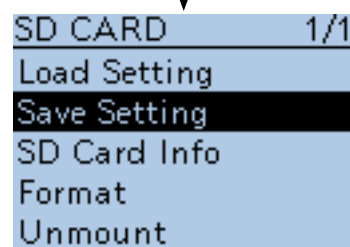
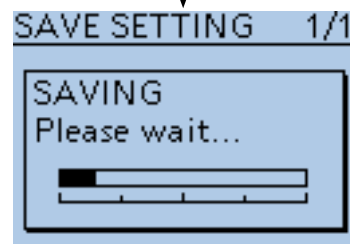
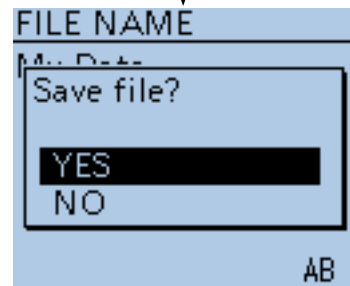
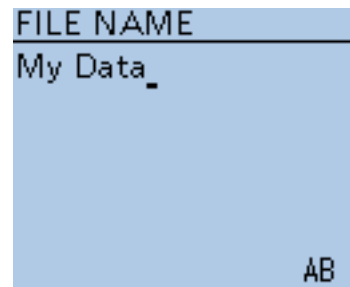
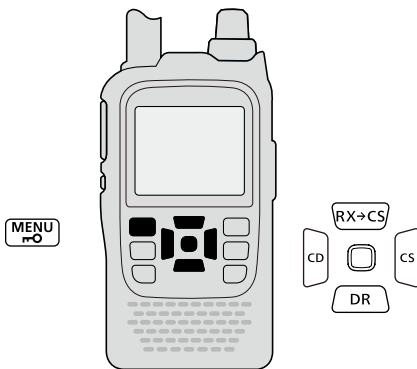

## ■ Loading the saved data files that are on the microSD card

The saved memory channels, item settings the in menu list and **repeater** lists can be copied to the transceiver. This function is convenient when copying the saved data, such as memory channels, or repeater lists, to another ID-51A/E and then operating with the same data.

To update the repeater list, [click here!](#) 

Saving the current data is recommended before loading other data in the transceiver.

**(Example:** Loading all the data in the “Set20121002\_01” file)

- ① Push [MENU] .
- ② Push D-pad(↑) to select the root item (“SD Card”), and then push D-pad(Ent).

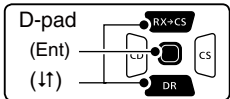

- ③ Push D-pad(↑) to select “Load Setting,” and then push D-pad(Ent).
- ④ Push D-pad(↑) to select the desired file to be loaded, and then push D-pad(Ent).  
**(Example:** Selecting “Set20121002\_01”)
- ⑤ Push D-pad(↑) to select the desired loading content, as shown below.

- ALL:  
Loads all memory channels, item settings in the menu list and the repeater list into the transceiver.
- Except My Station:  
Loads all memory channels, item settings in the menu list except MY call signs and the repeater list into the transceiver.
- Repeater List Only:  
Loads only the repeater list into the transceiver.

(☞ Continued on the next page)

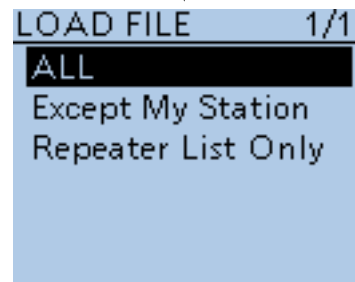
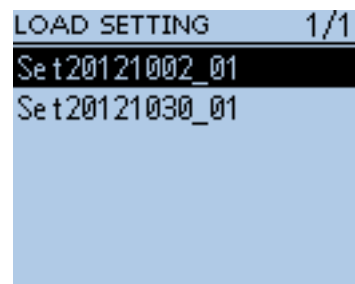
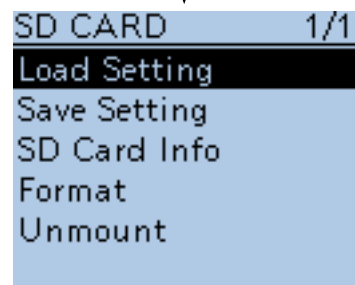
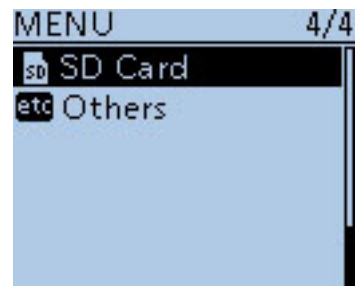
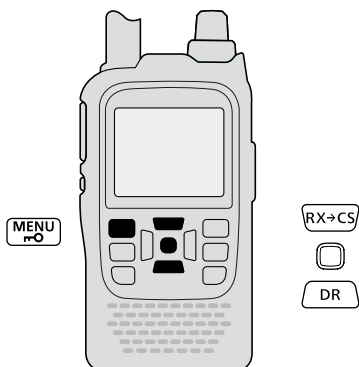

## 2 USING A microSD CARD

### ■ Loading the saved settings file that are on the microSD card (Continued)

- ⑥ Push D-pad(Ent) to select the file, and then the “Keep ‘SKIP’ settings in Repeater List?” appears.

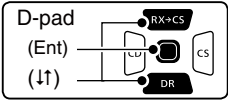

- ⑦ Push D-pad(↓) to select “YES” or “NO.”
- When “YES” is selected, the skip settings of the **repeater** list are retained. (p. 9-36)
- ⑧ Push D-pad(Ent), “Load file?” appears.
- ⑨ Push D-pad(↑) to select “YES,” then push D-pad(Ent) to start the file check.
- While checking the file, “CHECKING FILE” and a progress bar are displayed.
- ⑩ After checking, settings data loading starts.
- While loading, “LOADING” and a progress bar are displayed.
- ⑪ After loading, “COMPLETED!” appears.  
To complete the loading, reboot the transceiver.

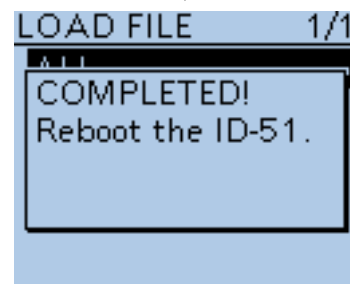
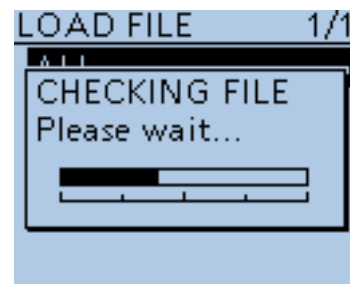
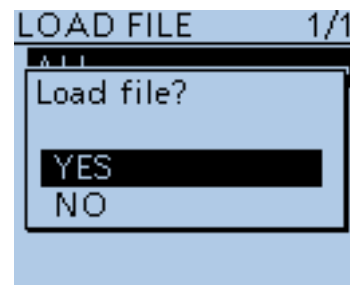
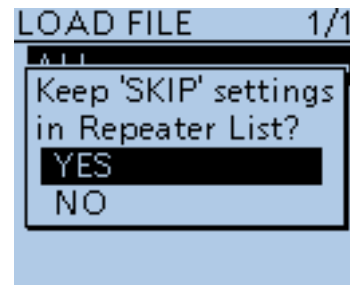

## ■ Backup the data stored on the microSD card onto a PC

A backup file allows easy restoring even if the setting data in the microSD card is accidentally deleted.

Depending on your PC, a memory card reader (purchase locally) may be additionally required to read the microSD card.

### ◇ About the microSD card's folder composition

The folder composition in the microSD card is as follows:

- ① ID-51 folder  
The folders created in the ID-51A/E are composed in this ID-51 folder.
- ② GPS folder  
GPS logging data is stored in the "log" format.
- ③ QsoLog  
QSO log data is stored in the "csv" format.
- ④ Reply folder  
Automatic reply data is stored in the "wav" format.
- ⑤ RxLog  
RX record log data is stored in the "csv" format.
- ⑥ Setting folder  
The transceiver's setting data is stored in the "icf" format.
- ⑦ Voice folder  
The recorded QSO audio date folders are created in the Voice folder.
- ⑧ yyyyymmdd folder  
Recorded audio file is stored in the "wav" format.  
The folder name is automatically created in the following manner:  
yyyyymmdd (yyyy:Year, mm:month, dd:day)
- ⑨ VoiceRec  
The recorded Voice recorder audio date folders are created in the VoiceRec folder.
- ⑩ VoiceTx  
Recorded voice audio data for the Voice TX function is stored in the "wav" format.

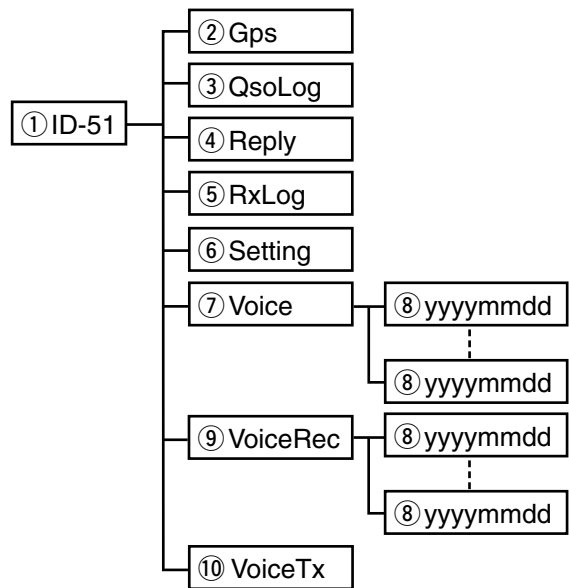

### (Example: Selecting the setting data)

When the microSD card is inserted into the microSD card drive of the PC or the microSD card reader (purchase locally), the screen appears as shown below.

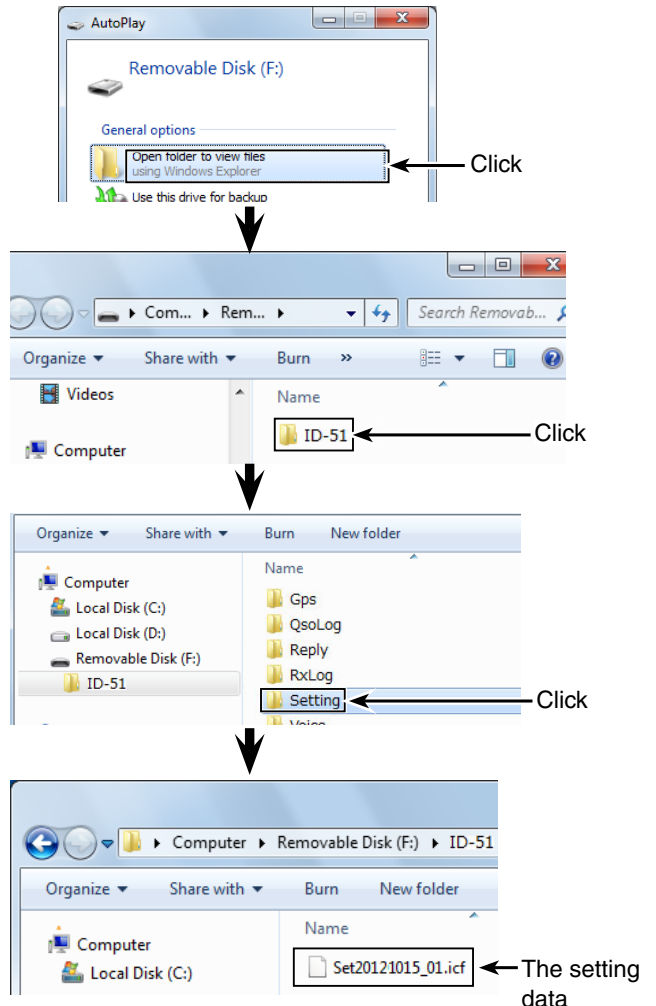

## 2 USING A microSD CARD

### ■ Backup the data stored on the microSD card onto a PC (Continued)

#### ◆ Make a backup file on your PC

Windows 7 is used for these instructions.

- ① Insert the microSD card into the microSD card drive on your PC.
  - If no microSD card drive is built-in, connect a memory card reader (purchase locally) and then insert the microSD card into it.
- ② Click the “Open folder to view files” option to access the card.

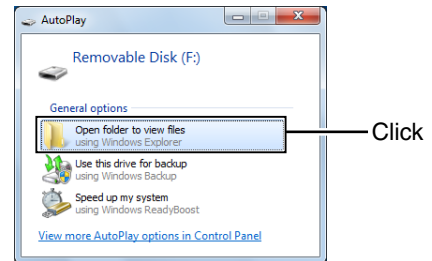

- ③ Select “Removal disk” and right click.
- ④ Click “Copy.”

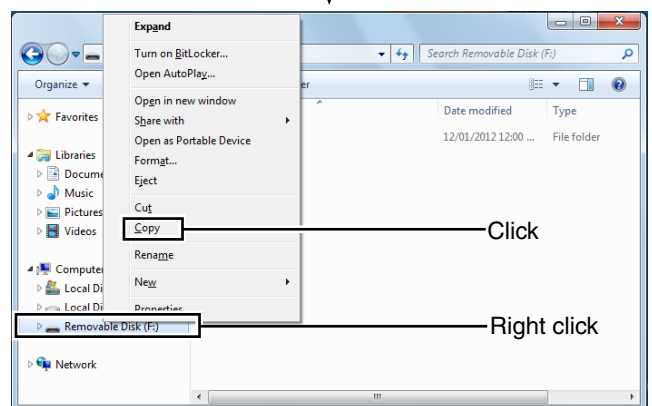

- ⑤ Open the desired folder to copied to, the right click then click “Paste” to copy the data that is in the microSD card onto the hard disk.  
(**Example:** Copying into the “Backup” folder in C drive)

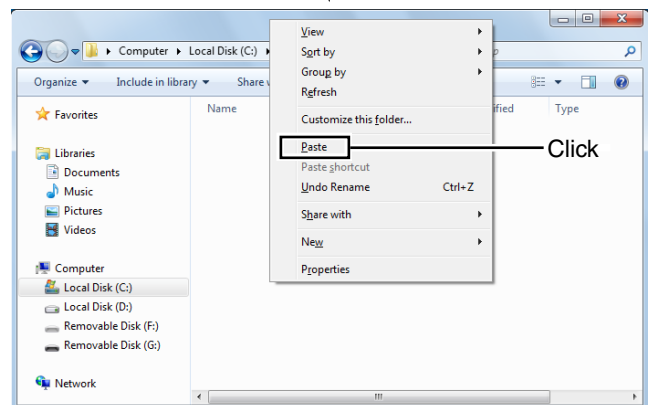

- ⑥ When removing the microSD card from the PC, click the microSD card icon in the task bar. (“Eject” icon in the screen shot as shown to the right.)
  - The screen shot shows when a memory card reader is connected.

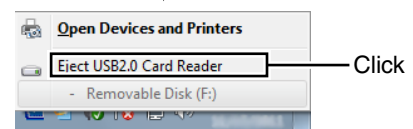

- ⑦ Remove the microSD card from the PC when “Safe To Remove Hardware” appears.
  - The screen shot shows when a memory card reader is connected.

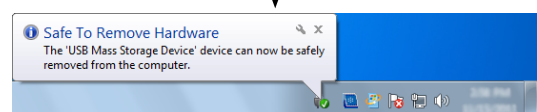



## ■ Updating the repeater list

For easy operation, the **repeater** list is preloaded into your transceiver.

This section describes how to manually update the repeater list using a microSD card.

The latest setting file can be downloaded from the Icom website.

### 1. Downloading the latest setting file (ICF file)

① Access the following URL to download the latest data.

<http://www.icom.co.jp/world/support/download/firm/index.html>

- The latest settings file (ICF file) and repeater list (CSV; Comma Separated Values file) are contained in the downloaded ZIP file.

**File Name:** 51\_U\_121201.zip

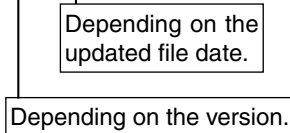

/// This instruction manual describes when the file name is “51\_U\_121201.zip,” for example.

② Decompress the compressed file that is downloaded from the Icom website.

“51\_U\_121201” folder will be created on the same place where the downloaded file is saved.

### 2. Inserting the microSD card into a PC

③ Insert the microSD card into the microSD card drive on your PC.

- Icom recommends that you format all microSD cards to be used with the ID-51A/E, even preformatted microSD cards for PCs or other uses.

See page 2-3 for details of inserting and removing the microSD card.

### 3. Copying the latest ICF file to the microSD card

④ Double-click the “51\_U\_121201” folder created on the same place where the downloaded file is saved.

⑤ Copy the ICF file (Example: “51\_USA\_121201.icf”) in the folder to the “Setting” folder in the “ID-51” folder of the microSD card.

Continued on the next page

ID-51A/E’s latest setting file is uploaded to “Cloning software(Rev. \* \*) and manuals” in the Icom website screen.

- The displayed contents may differ.

Model name	Description	last update
ID-51A ID-51E	Cloning software(Rev. * *) and manuals	2012/12/* *

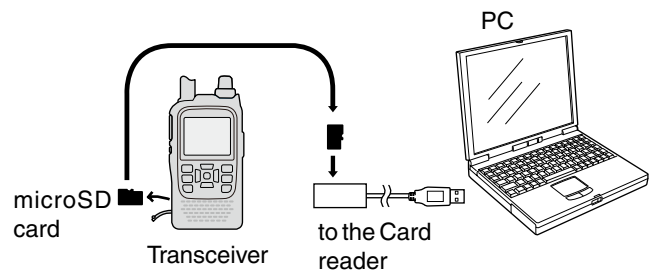

## 2 USING A microSD CARD

### ■ Updating the repeater list (Continued)

#### 4. Inserting the microSD card

- ⑥ Remove the microSD card from the PC, and insert the card into the transceiver's slot.

See page 2-3 for details of inserting and removing the microSD card.

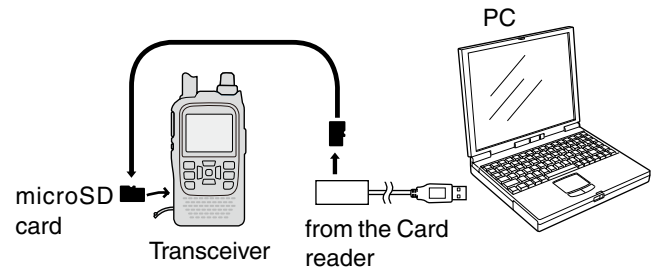

⚡ Saving the current data is recommended before loading other data into the transceiver.

#### 5. Updating the repeater list

- ⑦ Push [MENU] .
- ⑧ Push D-pad(↑) to select the root item ("SD Card"), and then push D-pad(Ent).

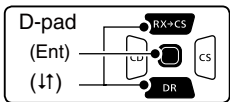

- ⑨ Push D-pad(↑) to select "Load Setting," and then push D-pad(Ent).
- ⑩ Push D-pad(↑) to select the ICF file to be loaded, and then push D-pad(Ent).  
(**Example:** Selecting "51\_USA\_121201.icf")
- The LOAD FILE screen appears.
- ⑪ Push D-pad(↑) to select "Repeater List Only," and then push D-pad(Ent).

⋮ Continued on the next page

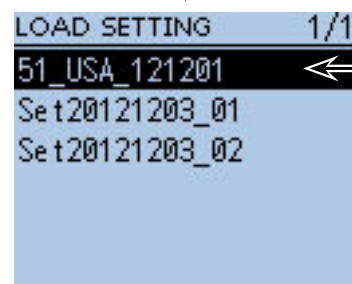
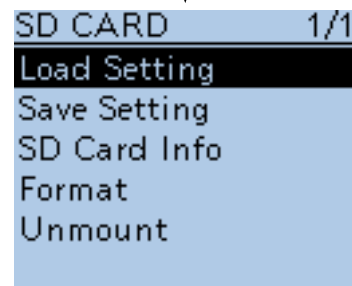
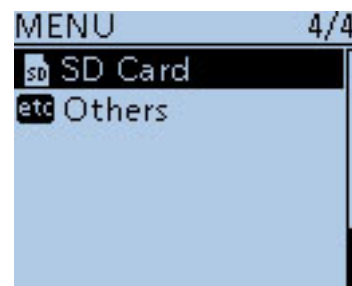

← Select the file to be loaded

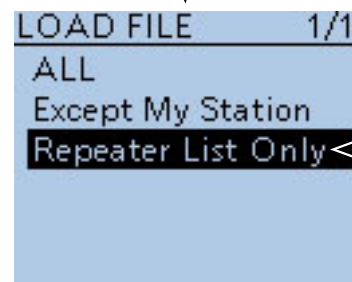

← Select

■ Updating the repeater list (Continued)

12 Push D-pad(Ent) to select the file, and then the “Keep 'SKIP' settings in Repeater List?” appears.

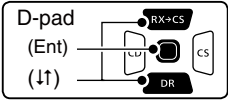

- 13 Push D-pad(↓) to select “YES” or “NO.”
- When “YES” is selected, the skip settings of the **repeater** list are retained. (p. 9-36)
- 14 Push D-pad(Ent), “Load file?” appears.
- 15 Push D-pad(↑) to select “YES,” then push D-pad(Ent) to start the file check.
- While checking the file, “CHECKING FILE” and a progress bar are displayed.
- 16 After checking, settings data loading starts.
- While loading, “LOADING” and a progress bar are displayed.
- 17 After loading, “COMPLETED!” appears.  
To complete the loading, reboot the transceiver.

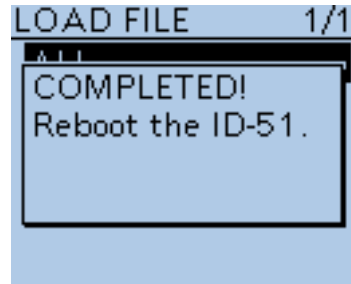
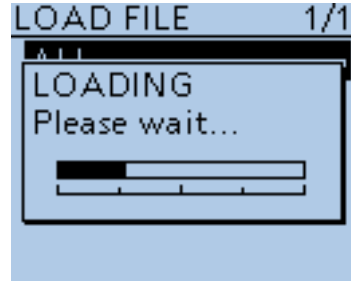
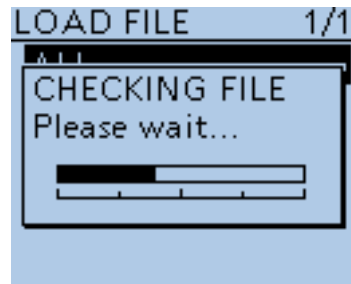
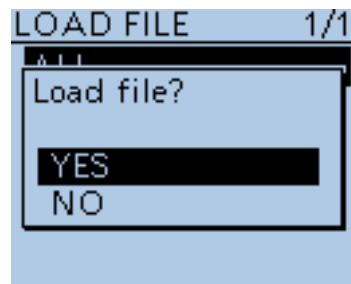
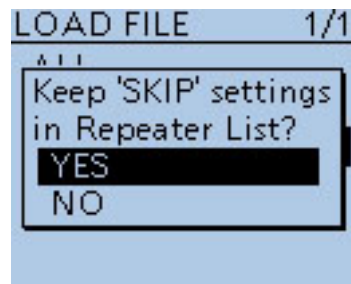

**Repeater list updating is complete!**

# Section 3

## PANEL DESCRIPTION

---

- Front, top and side panels ..... 3-2
- Function display ..... 3-5

## ■ Front, top and side panels

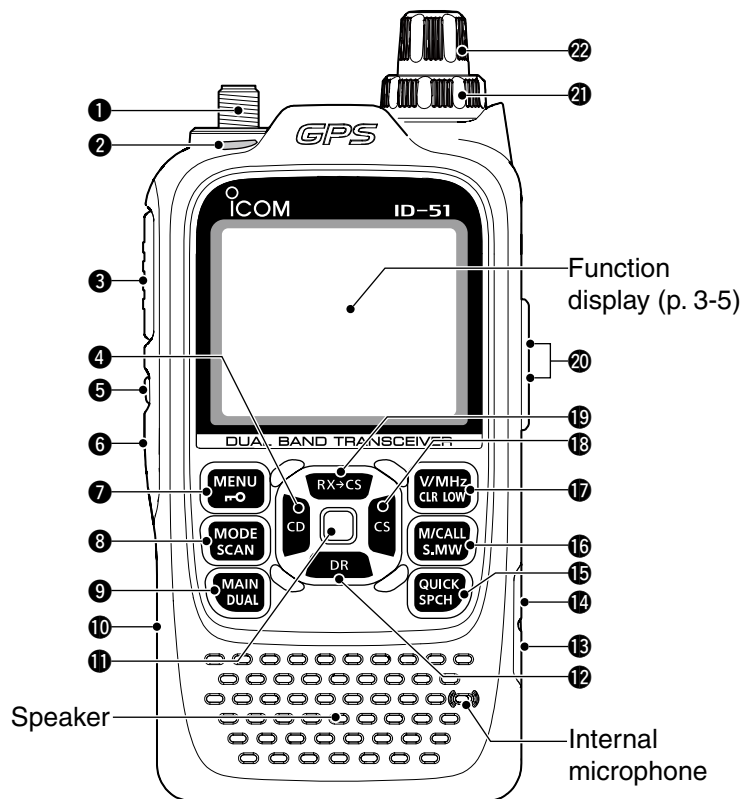

### 1 ANTENNA CONNECTOR (p. 1-2)

Connect the antenna here.

- An optional AD-92SMA adapter (p. 18-3) is available to connect an antenna with a BNC connector.

### 2 TX/RX INDICATOR [TX/RX] (pp. 5-9, 5-10)

Lights green while receiving a signal or when the squelch is open; lights red while transmitting.

### 3 PTT SWITCH [PTT] (p. 5-10)

Hold down to transmit, release to receive.

#### **For ID-51E only**

Push briefly, then hold down to transmit a 1750 Hz tone burst.

### 4 CD (RX CALLSIGN DISPLAY)/D-PAD (LEFT) KEY [CD]/D-pad(←)



- ➔ While in the DV mode, hold down for 1 second to open the received calls record. (p. 9-5)
- ➔ While in the DR mode, or with the Menu screen or Quick Menu screen opens, push to select an upper tier menu. (p. 16-2)

### 5 SQUELCH KEY [SQL]

- ➔ Hold down to temporarily open the squelch and monitor the operating frequency.
- ➔ While holding down this key, rotate [DIAL] to adjust the squelch level. (p. 5-6)

### 6 POWER KEY [⏻]

Hold down for 1 second to turn the transceiver power ON or OFF. (p. 5-2)

### 7 MENU • LOCK KEY [MENU ↵]



- ➔ Push to enter or exit the Menu screen. (p. 16-2)
- ➔ Hold down for 1 second to toggle the Key Lock function ON or OFF. (p. 5-11)

### 8 MODE • SCAN KEY [MODE•SCAN]



- ➔ Push to select the operating mode. (p. 5-7)
  - Selectable operating modes are AM, FM, FM-N or DV.
- ➔ Hold down for 1 second to enter the scan type selection mode. (pp. 13-5, 13-9)
  - Push again to start the scan.
  - Push  to stop the scan.

### 9 MAIN • DUAL KEY [MAIN•DUAL]



- ➔ Push to toggle the main band between A and B bands. (p. 5-3)
- ➔ Push and hold for 1 second to toggle the dualwatch function ON or OFF. (p. 5-3)

### 10 microSD CARD SLOT [micro SD]

Insert a microSD card of up to 32 GB SDHC.

### 11 ENTER KEY [ENT]

While in the DR mode, or with the Menu screen or Quick Menu screen open, push to open or set the selected item or option. (p. 16-2)

### 3 PANEL DESCRIPTION

#### ■ Front, top and side panels (Continued)

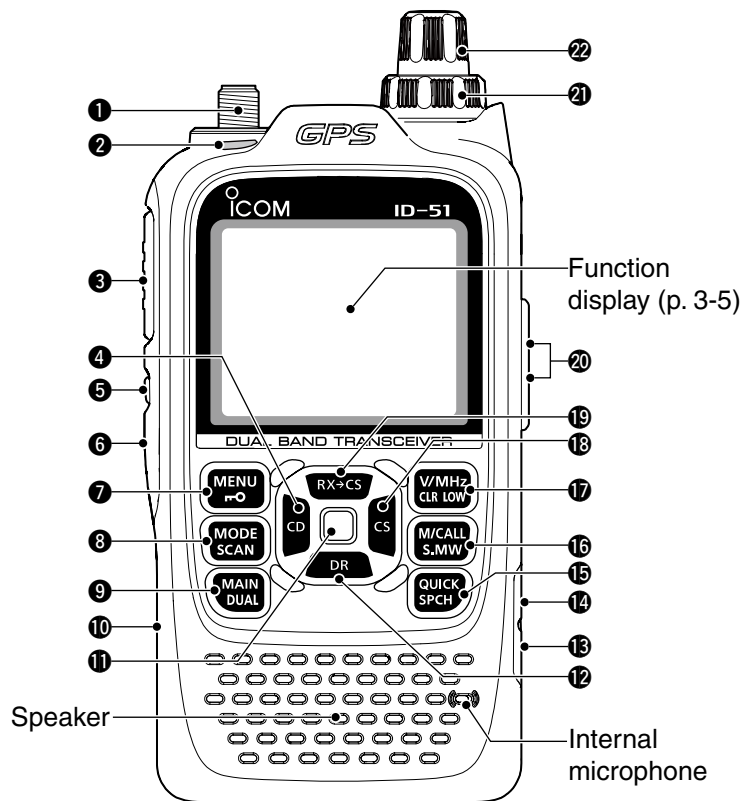

#### 12 DR (D-STAR REPEATER)/D-PAD (DOWN) KEY [DR]/D-pad(↓)

- ➔ Hold down 1 second to enter the DR mode. (p. 8-3)
- ➔ While in the DR mode, or with the Menu screen or Quick Menu screen open, push to move the value or option selector bar down. (p. 16-2)

#### 13 EXTERNAL DC IN JACK [DC IN]

- ➔ Connects to the supplied wall charger, BC-167SA/SD/SV, to charge the attached battery pack. (p. 4-3)
- ➔ Connect an external DC power supply through the optional CP-12L or CP-19R cigarette lighter cable or OPC-254L DC power cable for external DC operation. (p. 4-6)

#### 14 DATA JACK [DATA]

Connects to a PC through the optional OPC-2218LU data communication cable, for low-speed data communication in the DV mode or for cloning. The jack is also used to connect an external GPS receiver. See page 9-14 or 17-17 for more details.

#### 15 QUICK MENU • SPEECH KEY [QUICK SPCH]

- ➔ Push to enter or exit the Quick Menu screen. (p. 5-4)
  - The Quick Menu is used to quickly select various functions.
- ➔ Hold down for 1 second to audibly announce the displayed frequency, operating mode or call sign. (p. 17-6)

#### 16 MEMORY/CALL • SELECT MEMORY WRITE KEY [M/CALL•S.MW]

- ➔ In the VFO mode, push once to enter the Memory selection mode, push again to enter the Call channel mode. (p. 8-3)
- For ID-51A only**
- In the Call channel mode, push once to enter the Weather channel mode.
- ➔ Hold down for 1 second to enter the Select Memory Write mode. (p. 12-4)

#### 17 VFO/MHz • CLEAR • OUTPUT POWER KEY [VFO/MHz•CLR•LOW]

- ➔ Push to select the VFO mode. (p. 5-8)
- ➔ While in the VFO mode, push to select 1 MHz and 10 MHz tuning steps. (p. 5-6)
- ➔ With the Menu screen or Quick Menu screen open, push to return to the operating mode before entering the menu screen. (p. 16-2)
- ➔ While in the Memory Name or Call Sign Programming mode, push to delete the character. (p. 12-11)
- ➔ While scanning, push to cancel a scan. (pp. 13-5, 13-9)
- ➔ Hold down for 1 second to select the output power. (p. 5-10)
  - Select the transmit output power of High, Mid, Low2, Low1 or S-low.
  - While holding down this key, rotate [DIAL] to select the desired output power.

### 3 PANEL DESCRIPTION

■ Front, top and side panels (Continued)

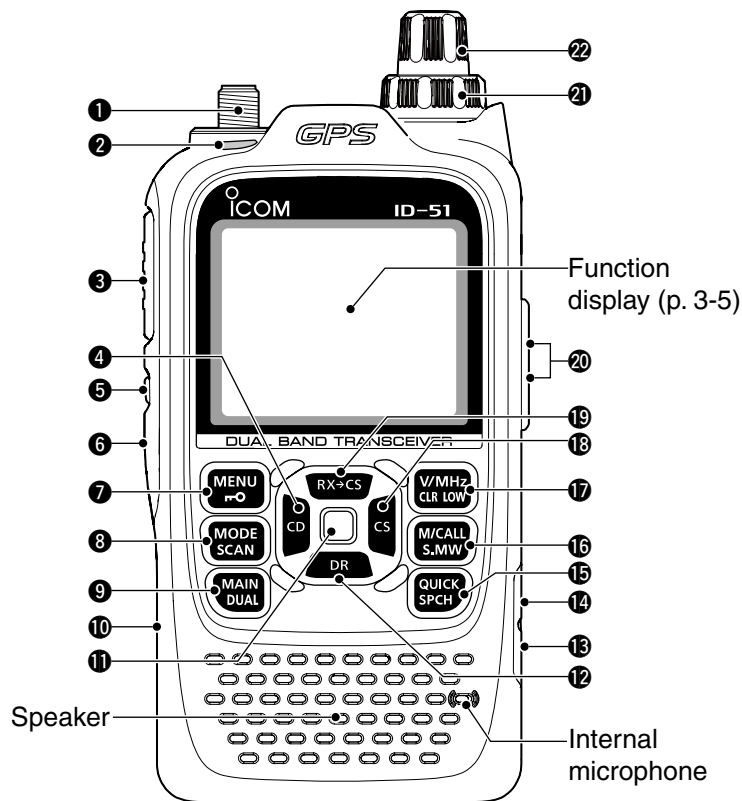

**16 CS (CALL SIGN SELECT)/D-PAD (RIGHT) KEY [CS]/D-pad(→)**



- ➔ Hold down for 1 second to enter the operating call sign select mode.
- ➔ While in the DR mode, or with the Menu screen or Quick Menu screen open, push to select a lower tier menu. (p. 16-2)

**19 RX->CS (RX CALL SIGN CAPTURE)/D-PAD (UP) KEY [RX->CS]/D-pad(↑)**



- ➔ Hold down for 1 second to set the received call signs (station and repeaters) as the operating call sign.
  - While holding down this key, rotate [DIAL] to select another call sign in the RX history.
- ➔ While in the DR mode, or with the Menu screen or Quick Menu screen open, push to move the value or option selector bar up. (p. 16-2)

**20 EXTERNAL MICROPHONE/SPEAKER JACK [MIC/SP]**

Connect a cloning cable, optional speaker microphone or headset, if desired.

See Section 18 for a list of available options.

Be sure to turn OFF the power before connecting or disconnecting optional equipment to or from the [MIC/SP] jack.

**21 VOLUME CONTROL [VOL]**

Rotate to adjust the audio volume level. (p. 5-2)

**22 CONTROL DIAL [DIAL]**

- ➔ Rotate to select the operating frequency. (p. 5-6)
- ➔ While in the Memory mode, rotate to select a memory channel. (p. 12-3)
- ➔ While scanning, rotate to change the scanning direction. (p. 13-3)
- ➔ Hold down [SQL], and rotate to select the squelch level. (p. 5-6)
- ➔ While in the DR mode, or with the Menu screen or Quick Menu screen open, rotate to select a desired option or value.

## ■ Function display

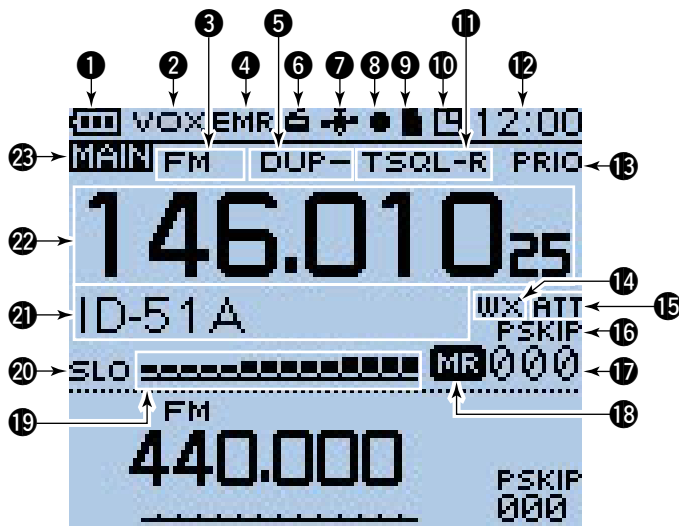

Dual band display

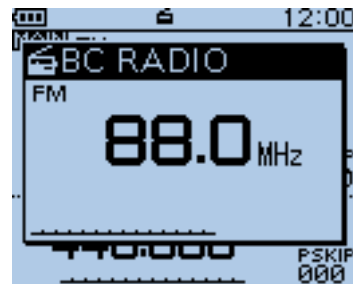

BC Radio setting pop-up window (Tuning mode)

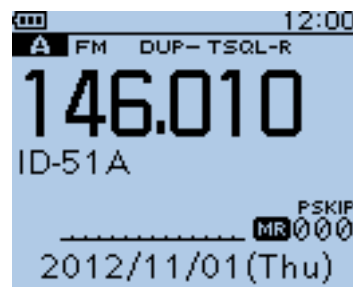

Single band display

### ❶ BATTERY ICON

- ➔ Shows the capacity of the attached battery pack in four levels. (p. 4-2)
  - "☐" (battery icon) appears when the battery pack is attached.
  - "☐" appears when the battery pack must be charged.
- ➔ "☐" appears when the optional battery case is attached. (p. 4-4)

### ❷ VOX ICON (p. 18-6)

Appears when the optional headset is connected with the OPC-2006LS PLUG ADAPTER CABLE, and the VOX function is ON.

### ❸ OPERATING MODE ICONS (p. 5-7)

- Shows the selected operating mode.
- DV, AM, FM and FM-N are selectable.
- "DV-G" or "DV-A" appears when GPS or GPS-A transmission is selected in the DV mode. (p. 10-16)

### ❹ EMR/BK/Packet Loss/Auto Reply ICON

- ➔ "EMR" appears when the Enhanced Monitor Request (EMR) mode is selected. (p. 9-8)
- ➔ "BK" appears when the Break-in (BK) mode is selected. (p. 9-7)
- ➔ "L" appears when Packet Loss has occurred. (p. 9-14)
- ➔ "AR" appears when the Automatic Reply function is selected. (p. 9-11)

### ❺ DUPLEX ICON (p. 15-5)

"DUP+" appears when plus duplex is selected, and "DUP-" appears when minus duplex is selected.

### ❻ BC RADIO ICON (p. 6-2)

Appears when the BC radio is ON.

### ❼ GPS ICON

- ➔ Appears while GPS function is in use. (p. 10-2)
- Stays ON when the GPS receiver is activated and valid position data is received.
- Blinks when invalid position data is being received.
- GPS icons can be turned OFF in the Menu screen. (p. 16-33)
- ➔ "((·))" blinks instead of the GPS icon, when the GPS alarm beeps. (p. 10-14)

### ❽ RECORD ICON (p. 11-2)

- Appears while recording.
- "■" appears while the transceiver is recording.
- "⏏" appears while the recording is paused.

### ❾ microSD ICON (Section 2)

- ➔ "■" appears when a microSD card is inserted.
- ➔ "■" and "■" alternately blinks while accessing the microSD card.

### ❿ AUTO POWER OFF ICON (p. 16-83)

Appears when the Auto power OFF function is ON.



### 3 PANEL DESCRIPTION

#### ■ Function display (Continued)

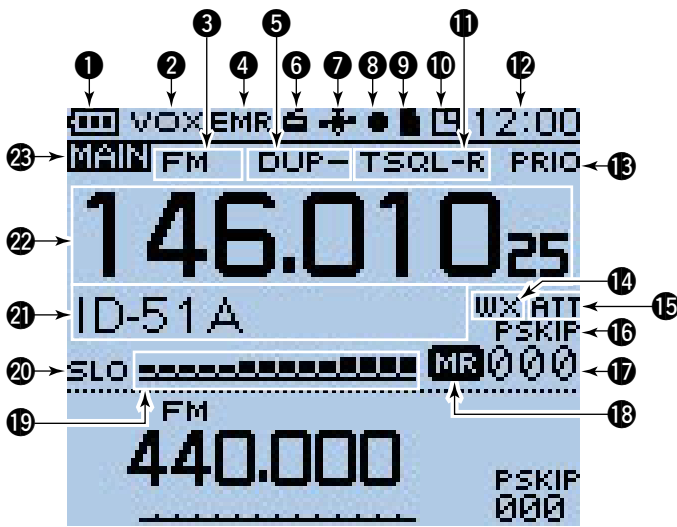

Dual band display

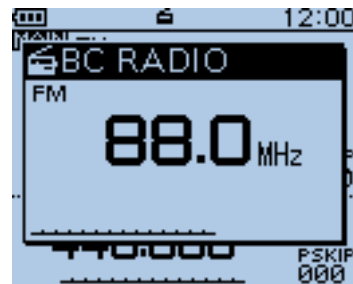

BC Radio setting pop-up window (Tuning mode)

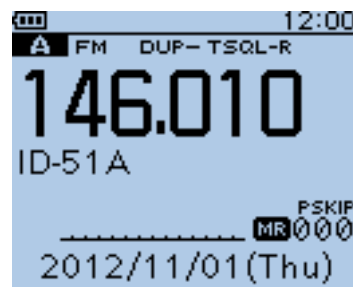

Single band display

#### ⑪ TONE ICONS

##### • While operating in FM/FM-N mode:

(pp. 17-13, 17-15)

- "TONE" appears while the Repeater Tone Encoder is ON.
- "TSQ" appears while the Tone squelch function is ON.
- "TSQ-R" appears while the Reverse Tone squelch function is ON.
- "DTCS" appears while the DTCS squelch function is ON.
- "DTCS-R" appears while the reverse DTCS squelch function is ON.
- "(·)" appears with the "TSQ" or "DTCS" icon while the Pocket Beep function (with CTCSS or DTCS) is ON.

##### • While operating in DV mode: (pp. 9-19, 9-20)

- "DSQL" appears while the Digital Call Sign squelch function is ON.
- "CSQL" appears while the Digital Code squelch function is ON.
- "(·)" appears with the "DSQL" or "CSQL" icon while the Pocket Beep function (with Digital Call Sign or Digital Code squelch) is ON.

#### ⑫ CLOCK DISPLAY (p. 16-82)

Displays the current time.

#### ⑬ PRIORITY WATCH ICON (p. 14-5)

Appears when Priority Watch is in use.

#### ⑭ WEATHER ALERT ICON (p. 5-15)

Appears when the Weather alert function is ON.

#### ⑮ ATTENUATOR ICON (p. 5-11)

Appears when the attenuator is ON in the AIR band.

#### ⑯ SKIP ICON (pp. 13-7, 13-8)

- "SKIP" appears when the selected memory channel is set as a skip channel.
- "PSKIP" appears when the displayed frequency is set as a skip frequency in the Memory mode.
- "PSKIP" appears while the Frequency Skip Scan function is ON in the VFO mode.

#### ⑰ MEMORY CHANNEL NUMBER

- Displays the selected memory channel or bank number. (p. 12-3)
- "C0" to "C3" appears when the Call channel is selected. (p. 12-3)

#### ⑱ MEMORY ICON (p. 12-3)

Appears when the Memory mode is selected.

### 3 PANEL DESCRIPTION

#### ■ Function display (Continued)

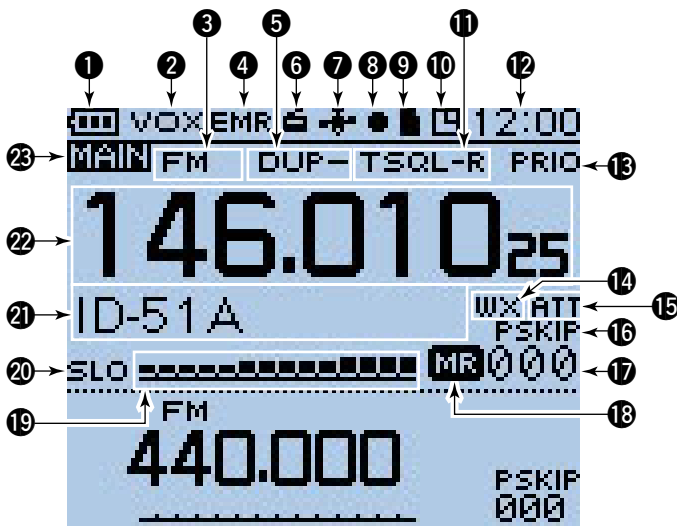

Dual band display

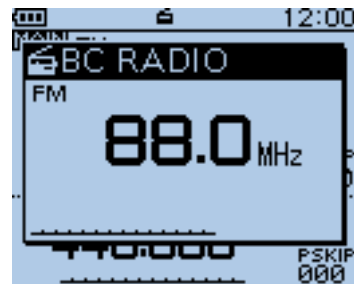

BC Radio setting pop-up window (Tuning mode)

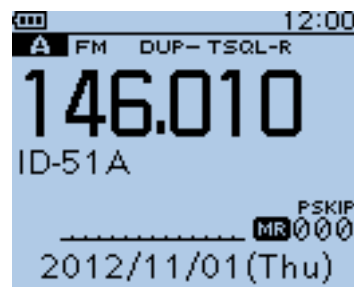

Single band display

#### 19 S/R F METER

- Shows the relative signal strength of the receive signal. (p. 5-9)
- Shows the output power level of the transmit signal. (p. 5-10)

#### 20 POWER ICONS (p. 5-10)

- "SLO" appears when S-low power is selected.
- "LO1" appears when low 1 power is selected.
- "LO2" appears when low 2 power is selected.
- "MID" appears when mid power is selected.
- No icon appears when high power is selected.

#### 21 MEMORY NAME DISPLAY (p. 12-12)

While in the Memory mode, the programmed memory or memory bank name is displayed.

#### 22 FREQUENCY READOUT

Displays a variety of information, such as the operating frequency, menu contents and so on.

- The decimal point blinks during a scan.

#### 23 MAIN BAND ICON (p. 5-3)

Shows the the selected band (A or B) is the Main band.

- Battery information ..... 4-2
  - ◇ Battery life ..... 4-2
  - ◇ Battery icon ..... 4-2
- Charging through the [DC IN] jack..... 4-3
  - ◇ Battery icon ..... 4-3
  - ◇ Charging note..... 4-3
- Optional battery case ..... 4-4
  - ◇ Battery life ..... 4-4
  - ◇ About the battery replacement ..... 4-4
- Charging with the optional desktop charger ..... 4-5
  - ◇ Charging note..... 4-5
- External DC power operation ..... 4-6
  - ◇ Operating note..... 4-6

## ■ Battery information

### ◇ Battery life

The approximate battery life (operating time) as shown to the right is calculated under the following assumptions:

- Power save setting: Auto (Short)
- Duty cycle: TX : RX : Stand-by = 1 : 1: 8 (based on operating style)





/// See page 4-4 for the optional BP-273 BATTERY CASE battery life.

Battery pack	FM mode	DV mode
BP-271	Approx. 4.5 hrs.	Approx. 4.5 hrs.
BP-272	Approx. 8 hrs.	Approx. 7 hrs.

### ◇ Battery icon

The “” battery icon appears when the BP-271 or BP-272 Li-ion battery pack is attached to the transceiver.

- /// • When the BP-273 battery case is attached to the transceiver, the battery icon cannot display the battery capacity of the alkaline batteries. The battery icon stays “”, and it does not reflect with the true battery capacity.
- /// • Without disconnecting the battery charger or external DC power, the battery icon does not appear when turning power ON after charging is completed.

Icon	Battery condition
	The battery has sufficient capacity.
	The battery is exhausted a little.
	The battery is nearing exhaustion. Charging is necessary. (The transceiver can be operated for a short time.)
	The battery is almost exhaustion. Charging is necessary. (The transceiver quickly becomes impossible to operate.)

## ■ Charging through the [DC IN] jack

Prior to using the transceiver for the first time, the battery pack must be fully charged for optimum life and operation.

**BE SURE** to turn OFF the power while charging. Otherwise the attached battery pack cannot be charged. (see page 4-6 for details)

### ◇ Battery icon

While charging, the charging icon “” sequentially shows eleven level steps along with the word “Charging...”.

The icon disappears when the battery pack is completely charged.



While charging

### ◇ Charging note

- When using the supplied BC-167S battery charger, be sure to turn OFF the transceiver power. Otherwise the battery pack will not be charged completely, or it will take much longer to charge.
- When using an optional CP-12L, CP-19R or OPC-254L, the battery pack can be charged at power ON. But by default, the battery pack cannot be charged at power ON, so you should turn OFF the power before charging. (p. 16-71)
- Even if rechargeable batteries, Ni-Cd or Ni-MH, are installed in the optional BP-273 battery case, they cannot be charged.
- The battery pack can be charged approximately 500 times.

- **Charging period:** BP-271 approximately 3.0 hours  
BP-272 approximately 4.5 hours

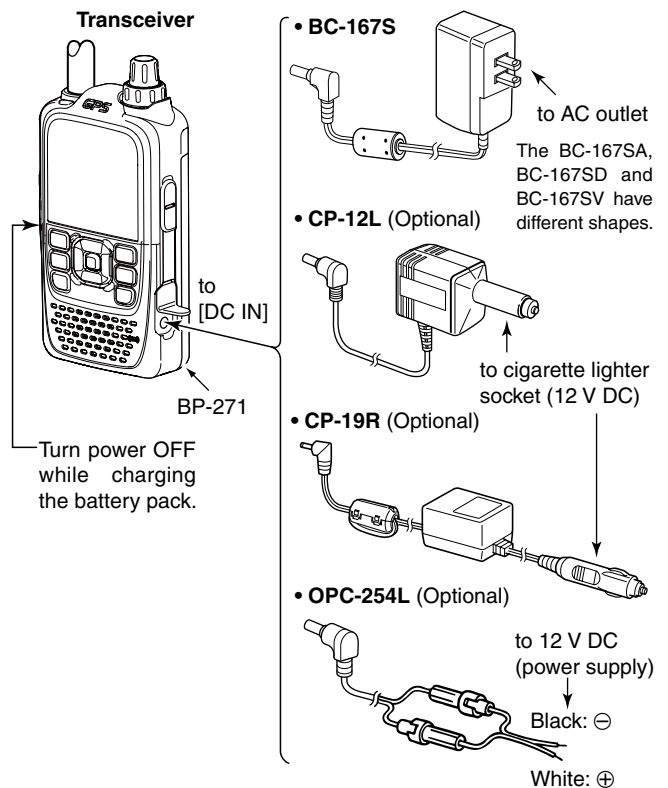

**BE SURE to attach the battery pack before connecting the DC cable.**

## ■ Optional battery case

When using the BP-273 BATTERY CASE, install three AA (LR6) size alkaline batteries, as described below.

- ① Remove the battery case if it is attached. (p. 1-2)
- ② Install three AA (LR6) size alkaline batteries.
  - Install only alkaline batteries.
  - Be sure to observe the correct polarity.
- ③ Attach the battery case. (p. 1-2)

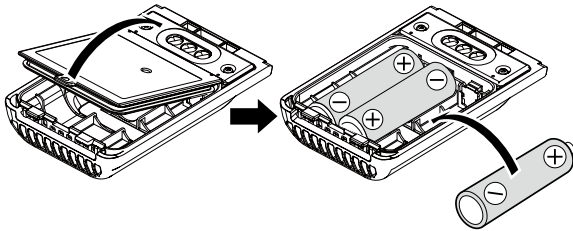

A built-in step-up converter in the BP-273 increases the voltage to 5.5 V DC. Approximately 100 mW of output power is possible with the BP-273 operation. Also, the transmit output power selection is disabled.

### CAUTION:

- When installing batteries, make sure they are all the same brand, type and capacity. Also, do not mix new and old batteries together.
- Keep the battery terminals clean. It's a good idea to occasionally clean them.
- Never incinerate used battery cells since the internal battery gas may cause them to rupture.
- Never expose a detached battery case to water. If the battery case gets wet, be sure to wipe it dry before using it.
- Never use batteries whose insulated covering is damaged.
- Remove the alkaline batteries when battery case is not used. Otherwise the installed alkaline batteries will exhausted due to built-in step-up converter.

### ◇ Battery life

The approximate battery life (operating time) as shown below is calculated under the following assumptions;

- Power save setting: Auto (Short)
- Duty cycle: TX : RX : Stand-by = 1 : 1: 8 (based on operating style)

FM mode	DV mode
Approx. 7.5 hrs.	Approx. 7 hrs.

### NOTE:

- The battery life may differ, depending on the operating style or the installed alkaline batteries.
- The batteries may seem to have low capacity when used in low temperatures, such as  $-10^{\circ}\text{C}$  ( $+14^{\circ}\text{F}$ ) or below. Keep the batteries warm in this case.

### ◇ About the battery replacement

When the alkaline batteries are almost exhausted, "LOW BATTERY" is displayed and the battery icon starts to blink. After 10 seconds, the transceiver power is automatically turned OFF.

In that case, replace all batteries with new alkaline batteries.

When the BP-273 battery case is attached to the transceiver, the battery icon cannot display the battery capacity of the alkaline batteries. The battery icon stays "■," and it does not reflect with the true battery capacity.

## ■ Charging with the optional desktop charger

The optional BC-202 rapidly charges of the BP-271 and BP-272 Li-ion battery packs.

- **Charging time:** BP-271 approximately 2.0 hours  
BP-272 approximately 3.5 hours

### ◇ Charging note

- Be sure to turn OFF the transceiver power.  
When the transceiver power cannot be turned OFF, detach the battery pack from the transceiver. Then charge the battery pack by itself, or charge the battery using regular charging. Otherwise the battery pack will not be charged (the charging indicator on the BC-202 blinks orange about 10 second after the battery pack is installed in BC-202).
- The BC-202 desktop charger can only charge BP-271 or BP-272 Li-ion battery packs. Other types of rechargeable batteries, Ni-Cd or Ni-MH cannot be charged.
- If the charging indicator blinks orange, there may be a problem with the battery pack or charger. If this occurs, try charging the battery pack alone, without the transceiver, or try using the standard (non-rapid) charger. Contact your dealer if you have problems charging a new battery pack.
- **NEVER** place the transceiver with the battery pack to the desktop charger when the transceiver is connected to the DC power supply. This may cause the charger's malfunction and the charging indicator of the charger lights red. In that case, disconnect the AC adapter from the charger, and then reconnect the AC adapter to the charger.
- The optional CP-23L and OPC-515L can be used instead of the supplied AC adapter. Connect one of these to the [DC 12-16V] jack.

### CAUTION: When using the OPC-515L DC power cable

NEVER connect the OPC-515L to a power source using reverse polarity. This will ruin the battery charger.

White line: ⊕      Black line: ⊖

**NOTE:** If the charging indicator blinks orange for 10 seconds or more with the battery pack installed in the transceiver, try charging the BP-271 alone. You can also try regular charging the BP-271 attached to the transceiver.

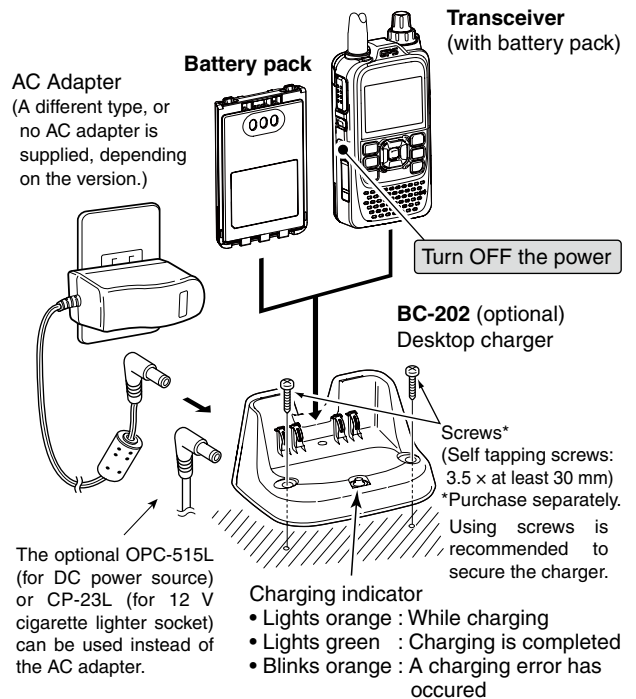

### IMPORTANT: Battery charging caution

Ensure the guide rails on the battery pack are correctly aligned with the tabs inside the charger.

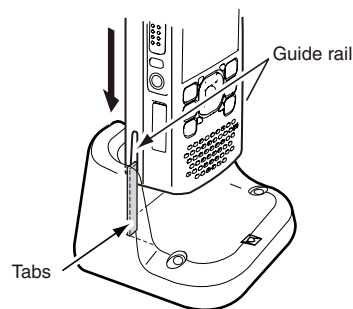

## External DC power operation

An optional CP-12L or CP-19R cigarette lighter cable, for a 12 V cigarette lighter socket, or an OPC-254L external DC power cable can be used for external power. The attached battery pack will not be charged while operating the transceiver if “Charging (Power ON)” is set to the factory default setting. If the setting is set to ON in the MENU screen, the battery pack can be charged.



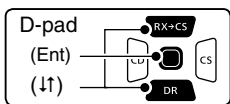

- The external DC power supply voltage must be between 10–16 V, and the current capacity must be more than 2.5 A to charge the battery pack when operating.

- 1 Connect the DC cable as shown to the right.
- 2 Push [MENU]  to enter the Menu screen.
- 3 Push D-pad(↑) to select the root item (Function), and then push D-pad(Ent) to go to the next level.



( MENU > Function > **Charging (Power ON)** )

- 4 Refer to the menu sequence shown directly above and push D-pad(↑) to select, and then push D-pad(Ent) to enter, one or more times until the last screen is displayed.
- 5 Push D-pad(↓) to select “ON.”
  - OFF: The transceiver cannot be charged when the power is ON.
  - ON : The transceiver can be charged even if the power is ON.

When the transceiver power is ON, the battery icon sequentially shows “,” “,” “” and “” while charging, and the icon disappears when the battery pack is completely charged.

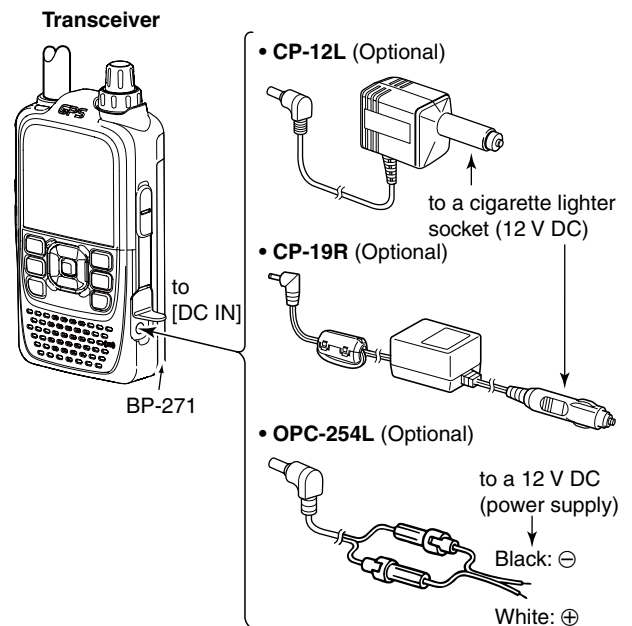

**BE SURE to attach the battery pack before connecting the DC cable.**

### “Charging (Power ON)” setting screen

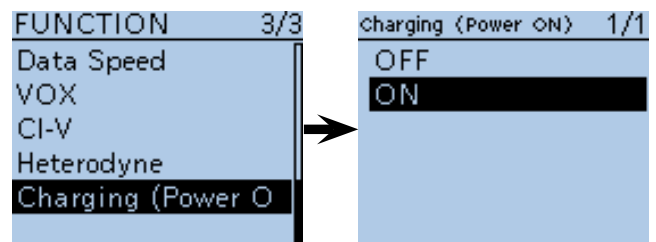

**NOTE:** Up to 5 W (approximately) of maximum output power is possible when using external DC power. However, when the supply voltage exceeds 14 V, the built-in protection circuit activates to reduce the transmit output power to approximately 2.5 W.

### ◇ Operating note

- The power supply voltage must be between **10.0–16.0 V DC**. **NEVER CONNECT OVER 16 V DC** directly into the [DC IN] jack of the transceiver.
- **BE SURE** to use a **CP-12L**, **CP-19R** or **OPC-254L** when connecting a regulated 12 V DC power supply. Use an external DC-DC converter to connect the transceiver through an optional CP-12L, CP-19R or OPC-254L to a 24 V DC power source.
- The voltage of the external power supply must be between 10–16 V DC when using either CP-12L, CP-19R or OPC-254L, otherwise, use the battery pack.
- Disconnect the power cables from the transceiver when not using it. Otherwise, the vehicle battery will become exhausted.

- The power save function is automatically deactivated when using an external DC power source.
- Be sure to observe the correct polarity of the OPC-254L supply connection.
- When external power is used, the power save function is automatically turned OFF.
- ID-51A/E’s charging circuit may generate certain spurious signals; the S-meter appears, or noise may be heard. When you operate the transceiver while charging, and if you cannot receive signals correctly, set “Charging (Power ON)” in the MENU screen to OFF.



- Power ON ..... 5-2
- Setting audio volume ..... 5-2
- MAIN band selection ..... 5-3
- Selecting the operating band..... 5-4
- Selecting a tuning step ..... 5-5
  - ◇ Tuning step selection ..... 5-5
- Setting a frequency ..... 5-6
- Setting the squelch level..... 5-6
- Selecting the operating mode..... 5-7
- Monitor function ..... 5-7
- Selecting the Mode..... 5-8
  - ◇ VFO mode ..... 5-8
  - ◇ Memory/Call channel/Weather channel\* mode.. 5-8
  - ◇ DR (D-STAR Repeater) mode ..... 5-8
- Receiving..... 5-9
- Transmitting ..... 5-10
  - ◇ About transmit power levels..... 5-10
- Key Lock function ..... 5-11
- ATT (AIR) function ..... 5-11
- Band Scope function ..... 5-12
  - ◇ Sweep operation ..... 5-12
- Dualwatch operation..... 5-13
  - ◇ MAIN band selection ..... 5-13
  - ◇ Setting the volume for Dualwatch..... 5-14
- Weather channel operation  
(U.S.A. version transceivers only)..... 5-15
  - ◇ Weather channel selection ..... 5-15
  - ◇ Weather alert function ..... 5-15

## ■ Power ON

- Hold down [PWR] for 1 second to turn ON power.
  - Hold down [PWR] for 1 second to turn OFF power.
  - After the opening message and power source voltage are displayed, the operating frequency appears.

▨ The opening message and power source voltage display options can be turned ON or OFF in the Display menu.

- ▨ MENU > Display > **Opening Message** (p. 16-76)
- ▨ MENU > Display > **Voltage (Power ON)** (p. 16-76)

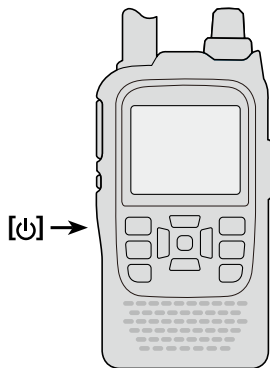

When "JA3YUA/ID51" is set as your own call sign and note.

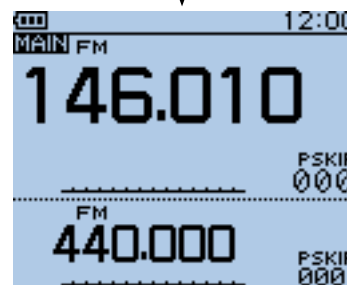
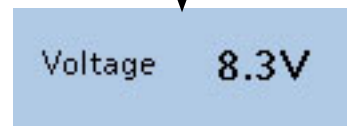

## ■ Setting audio volume

- Rotate [VOL] to adjust the audio level.
  - If the squelch is closed, hold down [SQL] while setting the audio level.
  - The display shows the volume level while adjusting.

▨ The beep level is adjusted in the Sounds menu.  
 ▨ MENU > Sounds > **Beep Level** (p. 16-79)

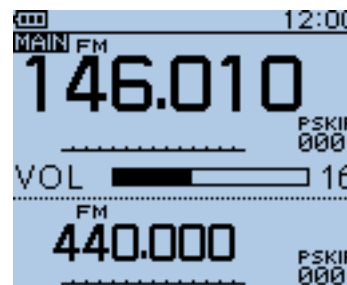

Volume level display

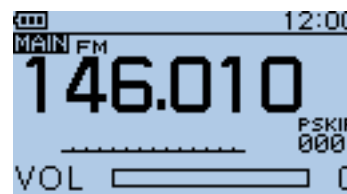

No audio

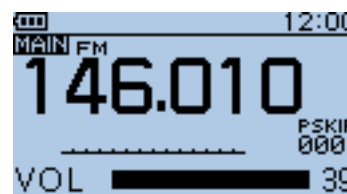

Maximum audio

## ■ MAIN band selection

The ID-51A/E has two independent operating bands; A band and B band.

The transceiver can monitor two frequencies simultaneously on A band and B band. This is called Dualwatch operation. (p. 5-13)

- Push [MAIN] <sup>(MAIN DUAL)</sup> to toggle the MAIN band between A and B band.
  - "MAIN" appears on the MAIN band.
- Hold down [DUAL] <sup>(MAIN DUAL)</sup> for 1 second to turn the dualwatch operation ON or OFF.
  - During Dualwatch operation, the display shows the A band in the upper half and the B band in the lower half.
  - When Dualwatch operation is OFF, the display shows only the MAIN band.

### Frequency range on the A/B bands:

108.000 MHz to 174.000 MHz
137.000 MHz to 174.000 MHz
380.000 MHz to 479.000 MHz

- Some frequency ranges are blocked for the U.S.A. and Australian version by regulation.

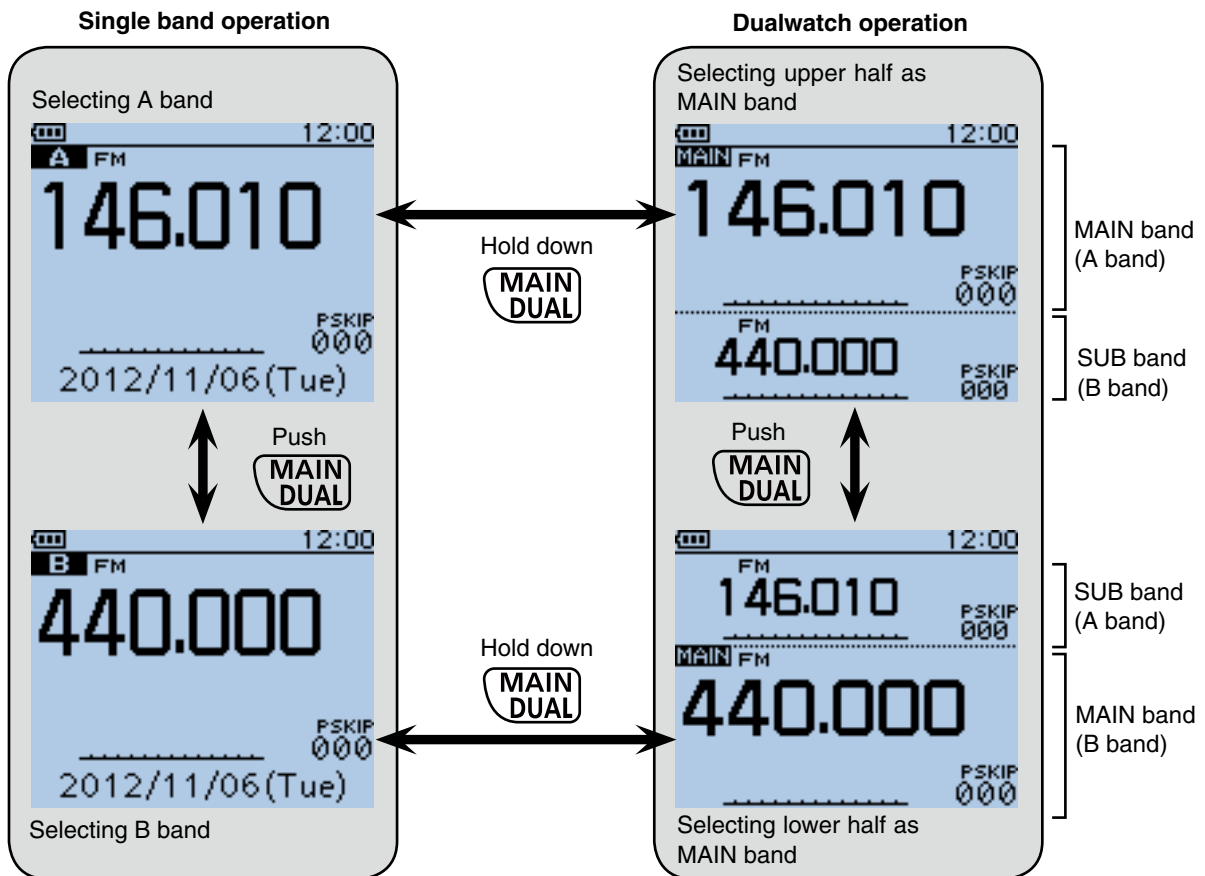
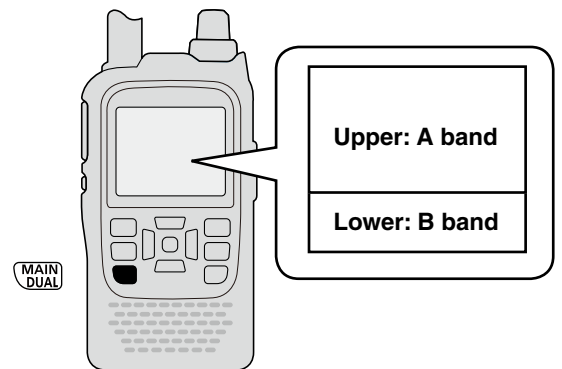

## ■ Selecting the operating band

The transceiver can receive the AIR, 144 MHz or 430 MHz bands.

- ① Push [V/MHz][V/MHz CLR LOW] to select the VFO mode, if necessary.
- ② Push [QUICK][QUICK SPCH] to open the Quick Menu screen.
- ③ Push D-pad(↑) to select “Band Select,” and then push D-pad(Ent).

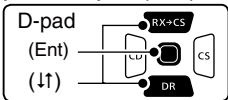

- ④ Push D-pad(↓) to select the desired frequency band.
  - Available frequency bands are differ, depending on version. See the specifications for details. (p. 19-2)
- ⑤ Push D-pad(Ent) to set and exit the Quick Menu screen.

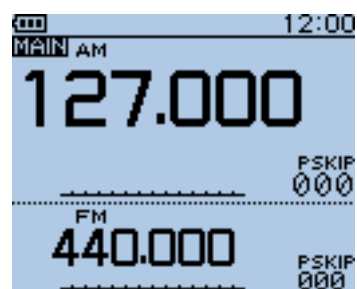
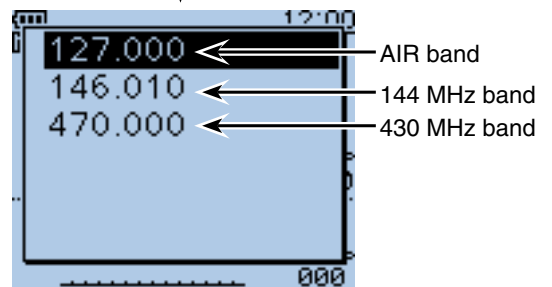
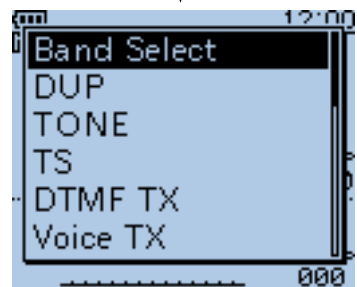
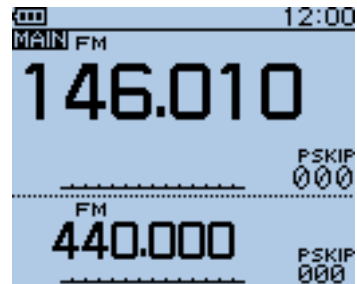
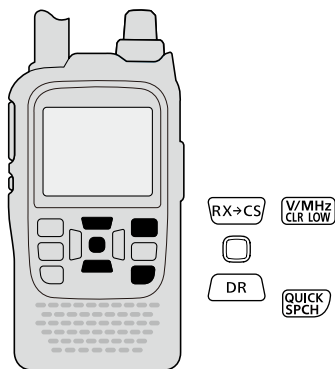

## ■ Selecting a tuning step

The following tuning steps are selectable. (kHz)

5.0	6.25	8.33*	10.0	12.5	15.0	20.0
25.0	30.0	50.0	100.0	125.0	200.0	

\*Appears only when the AIR band is selected.

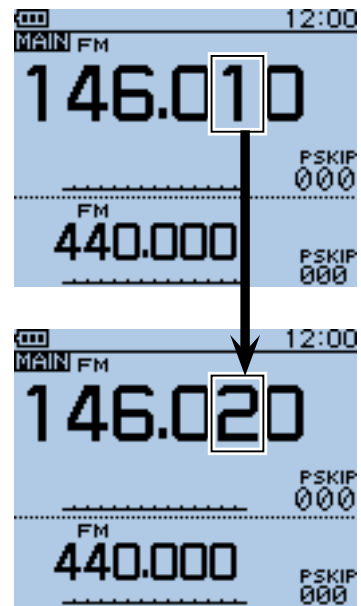

When 10 kHz tuning steps is selected, the frequency changes in the 10 kHz steps.

### ◇ Tuning step selection

- ① Push [QUICK] [QUICK SPCH] to open the Quick Menu screen.
- ② Push D-pad(↑) to select "TS," and then push D-pad(Ent).

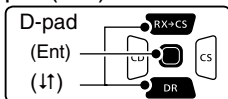

- ③ Push D-pad(↓) to select the desired tuning step.
- ④ Push D-pad(Ent) to save the setting and exit the Quick Menu screen.

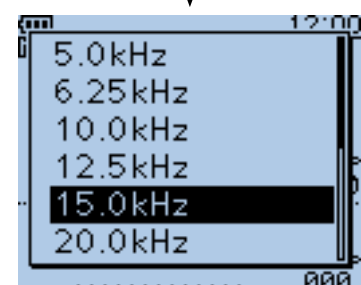
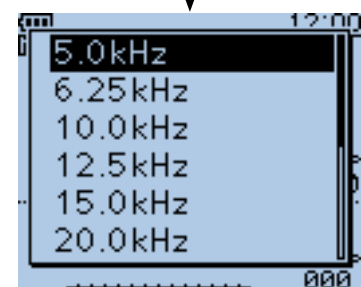
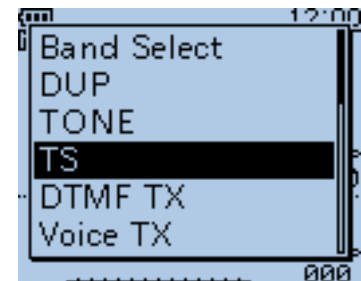
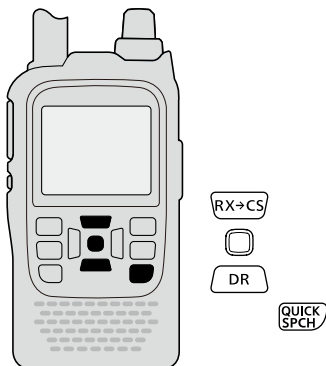

## ■ Setting a frequency

- ① When VFO mode is selected, push [V/MHz] <sup>V/MHz</sup> CLR LOW to select the 1 MHz or 10 MHz Quick Tuning function step, or turn it OFF.
  - When the 1 MHz step is selected, the frequency changes in 1 MHz steps.
  - When the 10 MHz step is selected, the frequency changes in 10 MHz steps.
- ② Rotate [DIAL] to select the desired frequency.
  - The frequency changes according to the selected tuning steps. See page 5-5 for details.

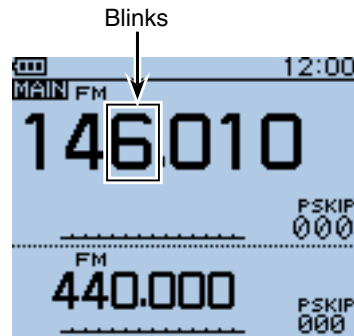

When the frequency changes in 1 MHz steps.

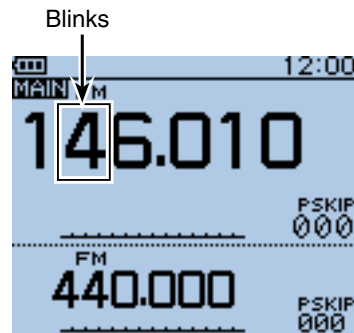

When the frequency changes in 10 MHz steps.

## ■ Setting the squelch level

The squelch function mutes the noise or received audio signal, depending on the signal strength and the squelch control setting.

- ➔ While holding down [SQL], rotate [DIAL] to select the squelch level.
  - While holding down [SQL], rotate [DIAL] one click to display the squelch level.
  - “LEVEL1” is loose squelch (for weak signals) and “LEVEL9” is tight squelch (for strong signals).
  - “AUTO” shows automatic level adjustment by a noise pulse counting system.
  - “OPEN” shows a continuously open setting. (This option is not selectable in the DV mode.)

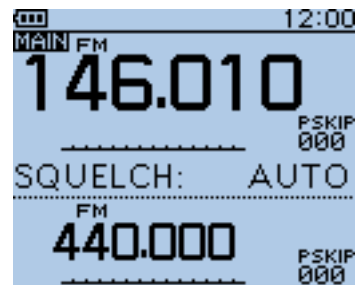

Automatic squelch

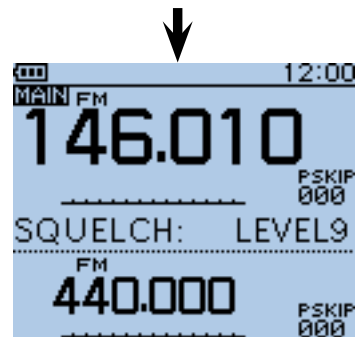

Maximum level

**NOTE:** The independent squelch level can be set to the A band and B band.  
 The squelch level setting can be done only for the MAIN band.

## ■ Selecting the operating mode

Operating modes are determined by the modulation of the radio signals. The transceiver has a total of four operating modes; AM, FM, FM-N and DV.

- ➔ Push [MODE]  one or more times to select a desired operating mode.
  - The AM mode can be used for only the AIR band (108.000 MHz to 136.995 MHz).
  - When the GPS TX Mode is set, “DV-G” or “DV-A” appears instead of “DV.” (p. 10-16)

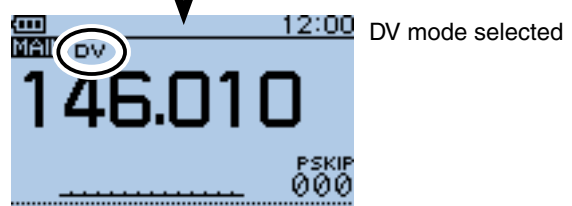
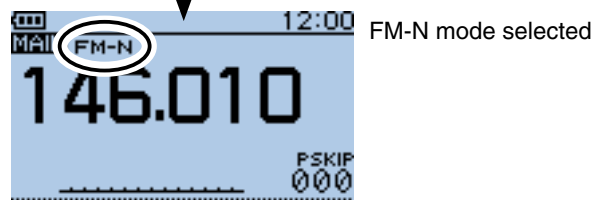
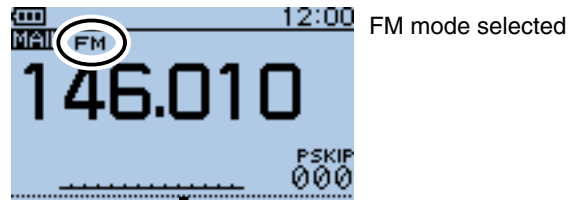
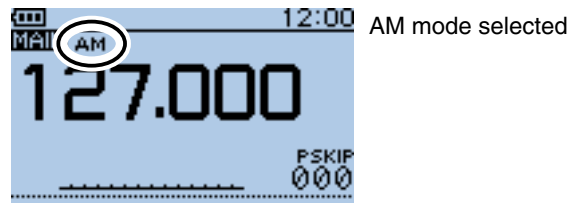

## ■ Monitor function

This function is used to listen to weak signals without disturbing the squelch setting, or having to open the squelch manually even when mute functions such as the tone squelch are in use.

- ➔ Hold down [SQL] to monitor the operating frequency.
  - The 1st segment of the S-meter blinks.

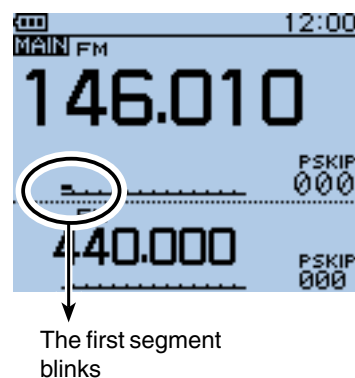

- ▨ The [SQL] key can be set to 'sticky' operation in Function menu.
- ▨ MENU > Function > **Monitor** (p. 16-66)



## ■ Selecting the Mode

### ◇ VFO mode

The VFO mode is used to set the desired frequency.

- ① Push [V/MHz]  to select the VFO mode.
  - When VFO mode is selected, push [V/MHz]  then rotate [DIAL] to change the frequency in 1 MHz steps. Or push [V/MHz]  again for 10 MHz steps.
- ② Rotate [DIAL] to set the operating frequency.

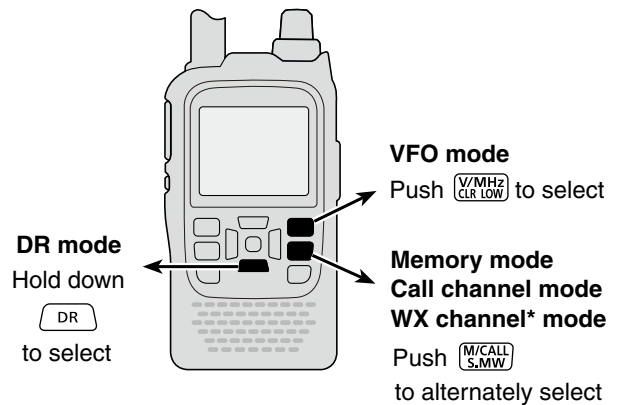

### ◇ Memory/Call channel/Weather channel\* mode

#### • Memory mode



Memory mode is used for operation on Memory channels, which store programmed frequencies.

#### • Call channel mode

Call channels are used for quick recall of most-often used frequencies.

#### • Weather channel mode\*

Weather channels are used for monitoring weather channels from the NOAA (National Oceanographic and Atmospheric Administration) broadcasts.

- ① When the VFO mode is selected, push [M/CALL]  to select the memory mode.
  - “MR” and the selected Memory channel number appear.
- ② Push [M/CALL]  again to select the Call channel mode, and then push again to select the Weather channel mode.
  - The Memory mode, Call channel mode or Weather channel mode\* are alternately selected.
  - While in the Call channel mode, the selected Call channel number (“C0” to “C3”) appears.
  - While in the Weather channel mode\*, the selected weather channel number (“WX-01” to “WX-10”) appears.
- ③ Rotate [DIAL] to select a desired channel.
  - Only programmed Memory channels can be selected.
  - See p. 12-4 for memory programming details.

\*Appears in only the U.S.A. version transceivers.

### ◇ DR (D-STAR Repeater) mode

The DR (D-STAR Repeater) mode is used for D-STAR **repeater** operation. In this mode, you can easily select the preprogrammed repeaters and UR call signs by rotating [DIAL].

- ① Hold down  for 1 second to select the DR mode.
- ② Rotate [DIAL] to select a desired access repeater.

#### • VFO mode



#### • Memory mode

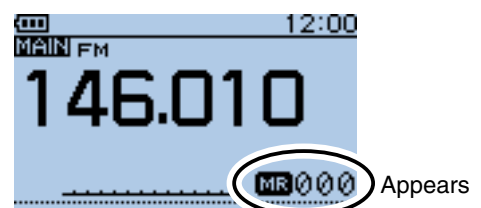

#### • Call channel mode

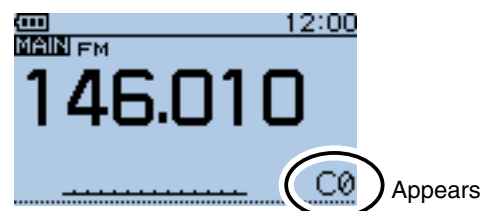

#### • Weather channel mode\*

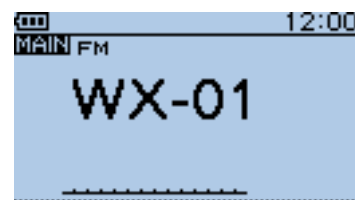

#### • DR mode

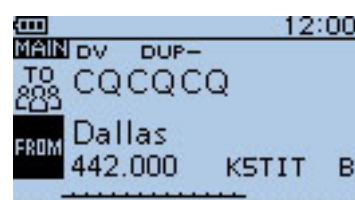



## ■ Receiving

Example: Receiving on 145.510 MHz

- ① Push [V/MHz]<sup>[V/MHz CLR LOW]</sup> to select the VFO mode, if necessary.
- ② Push [QUICK]<sup>[QUICK SPCH]</sup> to open the Quick Menu screen.
- ③ Push D-pad(↑) to select “Band Select,” and then push D-pad(Ent).

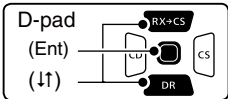

- ④ Push D-pad(↓) to select the desired band.
    - Example: “146.010”
    - The last frequency operated on the band is displayed.
    - The displayed frequency will appear after band selection.
  - ⑤ Push D-pad(Ent) to save the setting and exit the Quick Menu screen.
  - ⑥ Push [MODE]<sup>[MODE SCAN]</sup> to select the FM mode.
  - ⑦ Rotate [DIAL] to select “145.510 MHz.”
- When a signal is received:
- The Squelch opens and audio is heard.
  - The TX/RX indicator lights green.
  - The S-meter shows the relative signal strength level.

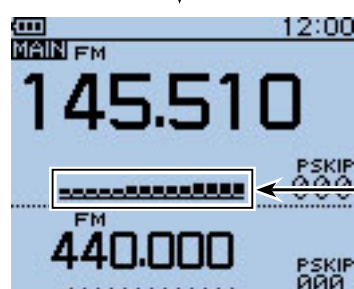
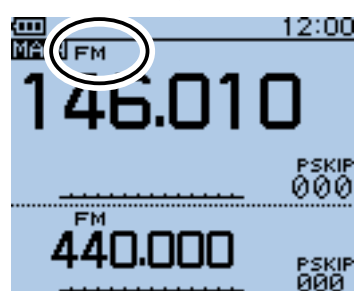
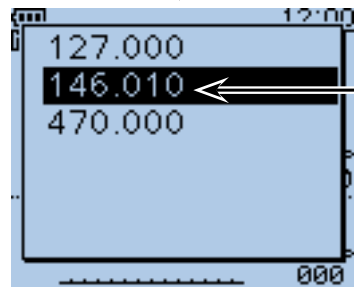
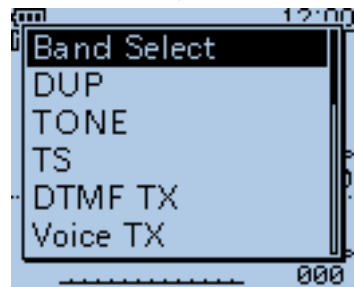
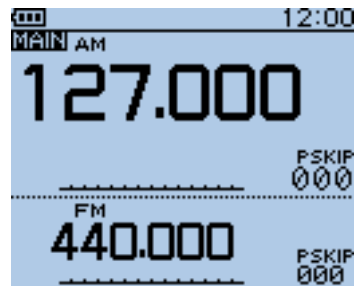
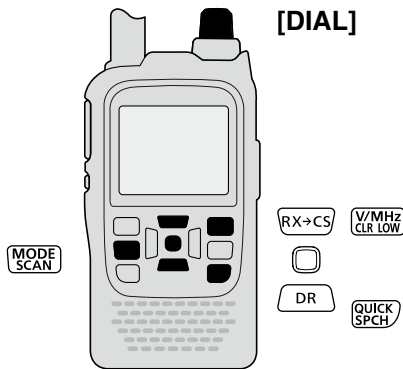

## ■ Transmitting

**CAUTION:** Transmitting without an antenna will damage the transceiver.

**NOTE:** To prevent interfering, hold down [SQL] to listen on the channel before transmitting.

- ① Set the operating frequency. (p. 5-6)
  - Transmitting can be done only when the 144 MHz or 430 MHz amateur band is selected as the MAIN band.
- ② Hold down [LOW]<sup>(V/MHz CLR LOW)</sup> for 1 second to select the transmit output power between S-Low, Low1, Low2, Mid and High to suit your operating requirements.
  - Or while holding down [LOW]<sup>(V/MHz CLR LOW)</sup>, rotate [DIAL] to select the output power.
  - Lower output power during short-range communications may reduce the possibility of interference to other stations, and will conserve battery power.
  - “SLO”/“LO1”/“LO2”/“MID” appears when S-low/low 1/low 2/mid power is selected.
  - No icon appears when high power is selected.
- ③ Hold down [PTT] to transmit.
  - The TX/RX indicator lights red.
  - The S/RF meter displays the output power level.
- ④ Speak at your normal voice level.
  - DO NOT hold the transceiver too close to your mouth or speak too loudly. This may distort your speech.
- ⑤ Release [PTT] to receive.

**WARNING!** NEVER transmit for long periods of time.

During prolonged transmissions at high power or mid power, the transceiver radiates heat to protect itself from overheating. The transceiver's chassis will become hot and may cause a burn.

- To prevent the transceiver's overheating, the default setting of the time-out timer function is set to 5 minutes (p. 16-68). Be careful when the time-out timer function is turned OFF or set to a long time period, and you transmit for long periods.

**DO NOT** operate the transceiver in a situation that will obstruct heat dissipation, especially if the transceiver uses an external power supply. Heat dissipation may be affected, and it may cause a burn, warp the casing or damage the transceiver.

**NOTE:** When the transceiver becomes hot, the transceiver's heat protection function gradually reduces the output power to approximately 2.5 watts, then it stops transmission after that. This is done to protect the transceiver itself until it can cool down.

**CONNECT** to only the rated voltage range when using an external power supply.

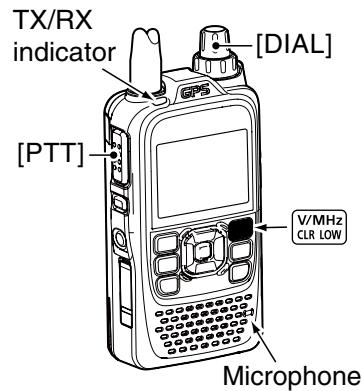

### ◇ About transmit power levels

- When the external DC power cable (13.5 V DC) is connected or BP-271/BP-272 is attached.
  - : 5 W (High)/2.5 W (Mid)/1.0 W (Low2)/0.5 W (Low1)/0.1 W (S-Low) (approximately)
- When the BP-273 is attached.
  - : Approximately 0.1 W (S-LOW) (fixed)

**NOTE:** When using the BP-273 battery case, “SLO,” “LO1,” “LO2,” “MID” or no icon (high power) appears on the display by holding down [LOW]<sup>(V/MHz CLR LOW)</sup> for 1 second. But “SLO” appears while transmitting, and the output power is limited to approximately 0.1 watts.

### • Transmit power level display

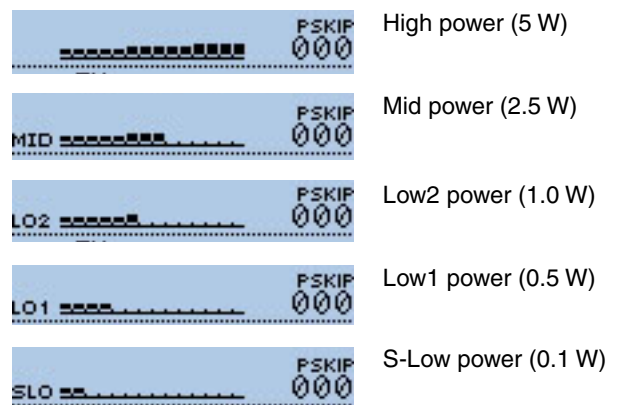

## ■ Key Lock function

Activate to prevent accidental frequency changes and unnecessary function access.

- ➔ Hold down [LOCK]<sup>[MENU]</sup> for 1 second to turn the Key Lock function ON or OFF.
  - When the Key Lock function is activated and the locked key or dial is pushed or rotated, "LOCK ON" appears.
  - [↓], [LOCK]<sup>[MENU]</sup>, [PTT], [SQL] and [VOL] can be used while the lock function is activated.

- ⚡ Either or both the squelch control and volume control can also be locked in the Function menu.
- ⚡ MENU > Function > **Key Lock** (p. 16-68)

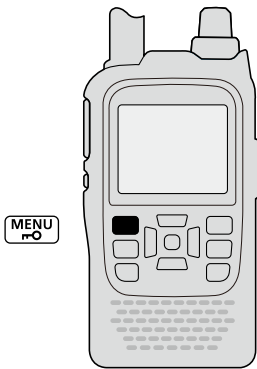

The function is ON



The function is OFF

## ■ ATT (AIR) function

The attenuator reduces signal levels to prevent audio distortion. This is useful when the transceiver receives a very strong air band signal, or it is in very strong electromagnetic fields such as from a broadcasting station near your location.

The attenuation is about 30 dB, and enabled when the AIR band is selected.

- ① Push [QUICK]<sup>[QUICK SPCH]</sup> to open the Quick Menu screen.
- ② Push D-pad(↑) to select "ATT (AIR)," and then push D-pad(Ent).

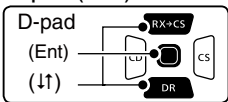

- ③ Push D-pad(↓) to select "30dB."
- ④ Push D-pad(Ent) to set, and exit the Quick Menu screen.
  - "ATT" appears.

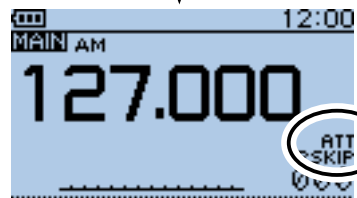
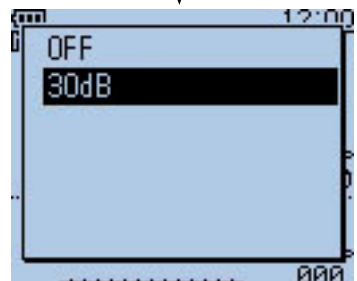
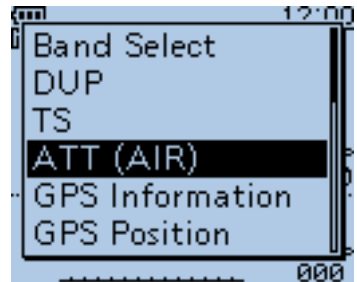
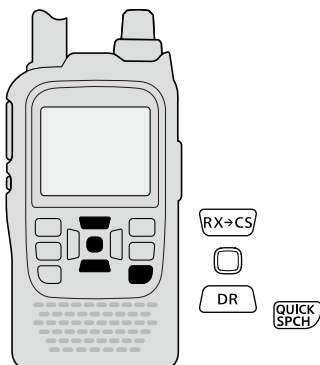

## ■ Band Scope function

The Band Scope function allows you to visually check a specified frequency range around the center frequency.

Example: The tuning step is set to 10 kHz, and a strong signal is received on 146.060 MHz.

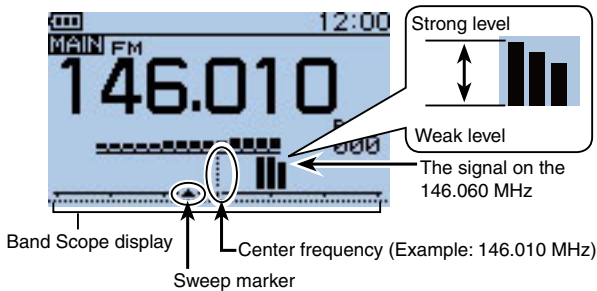

### About the sweep steps:

The specified tuning step (in VFO mode) or programmed tuning step (in memory mode) is used during sweep. If the tuning step is set to wide, the present signal may not be displayed (may be skipped), even that is strong signal. Thus we recommend to set the tuning step to the 20 kHz or less to use the Band Scope function. See page 5-5 for the Tuning step selection details.

- For the single watch operation within 144 MHz or 430 MHz band, the displayed frequency's audio sounds during a sweep.
- In the AIR band, the displayed frequency's audio does not sound during a sweep, even if the single watch operation is selected.
- The audio output during a sweep can be turned OFF in the MENU screen.  
MENU > Sounds > **Scope AF Output** (p. 16-81)

### ◇ Sweep operation

- ① Push [QUICK] [QUICK SPCH] to open the Quick Menu screen.
- ② Push D-pad(↓) to select "Band Scope," and then push D-pad(Ent).

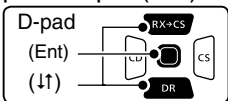

- ③ Push D-pad(↓) to select the option between "Single Sweep" and "Continuous Sweep."
- ④ Push D-pad(Ent) to return to the frequency display and start sweeping.
  - A single Sweep checks the specified frequency range only one time.
  - A continuous Sweep repeatedly checks the specified frequency range.
  - Push D-pad(Ent) to stop sweeping and push again to restart it.
  - When the sweeping stops, rotate [DIAL] to move the sweep marker to a detected signal; you can hear the signal audio.
  - When the sweeping stops, push [CLR] [V/MHz CLR LOW] to cancel the Band Scope function.

Example: Continuous sweep on 146.010 MHz

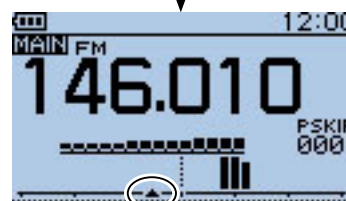
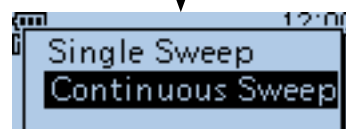
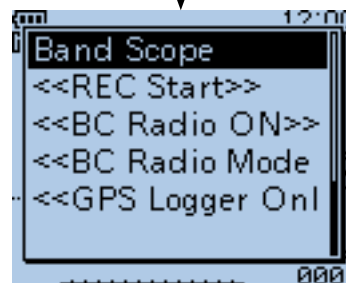
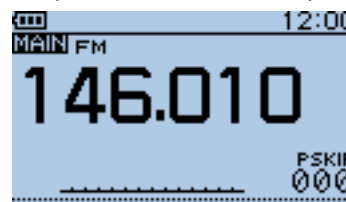

While continuously sweeping

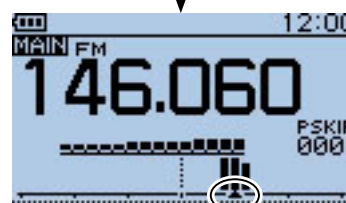

When the sweeping stops, rotate [DIAL] to move the sweep marker to a detected signal; you can hear the signal audio.

## ■ Dualwatch operation

Dualwatch operation simultaneously monitors two frequencies.

The ID-51A/E has two independent receiver circuits as A band and B band.

Depending on the operating band or mode, the SUB band audio signal is muted. In such case, "MUTE" appears.

During the dualwatch operation, the audio output may be interrupted when the frequency is switched while scanning, or by other factors.

### A/B band selection in the DR mode

The DR mode screen can be displayed on the A band (upper) or B band (lower).

When the DR mode is displayed on the A band, and the DR mode is selected in the B band, the previously displayed frequency or memory before entering the DR mode is displayed on the A band.

#### • Display image for the DR mode

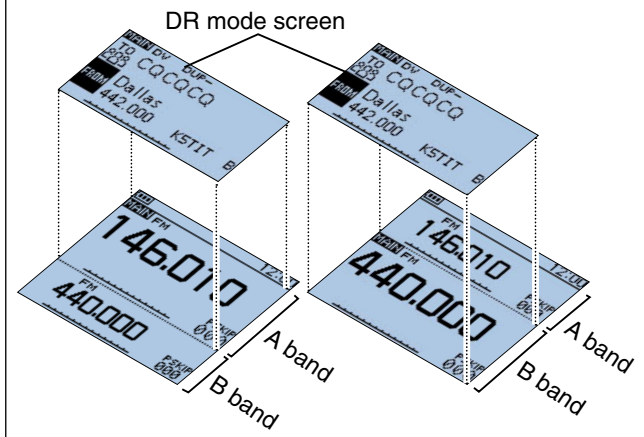

### ◇ MAIN band selection

➔ Push [MAIN] (MAIN DUAL) to alternately select upper half band or lower half band as the MAIN band.

- "MAIN" appears on the MAIN band.
- "Band selection, operating frequency input using [DIAL], operating mode selection, Memory channel selection, memory write and band scope function can be made on the MAIN band.

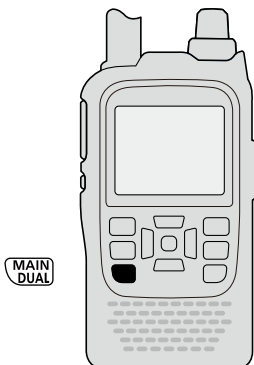

### ○ SUB band mute status

MAIN band	SUB band
DV mode	DV mode
	FM-N mode
FM-N mode	DV mode
	FM-N mode
AIR band	AIR band

Example: MAIN band is FM-N mode.  
SUB band is DV mode.

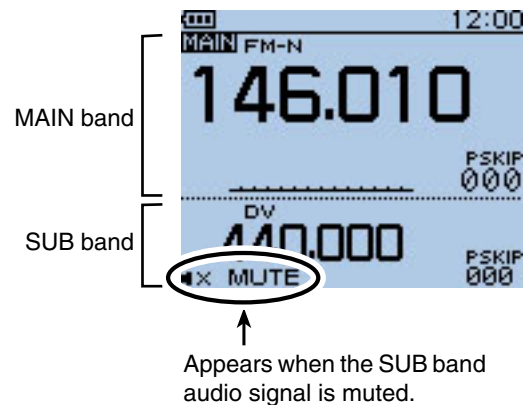

Appears when the SUB band audio signal is muted.

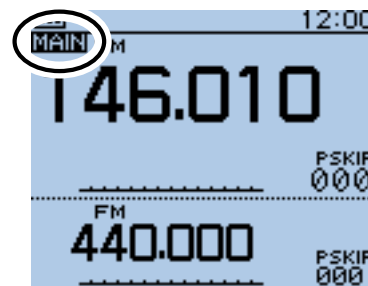

MAIN band is upper half

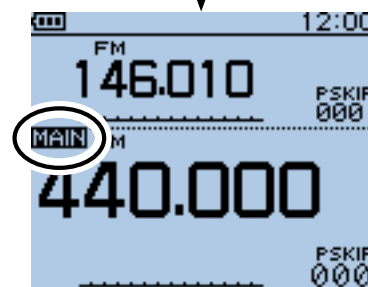

MAIN band is lower half

■ Dualwatch operation (Continued)

◇ **Setting the volume for Dualwatch**

The volume setting for Dualwatch can be set for both bands simultaneously or for each band separately, in the MENU screen.

- ① Push [MENU]  to enter the Menu screen.
- ② Push D-pad(↑) to select the root item (Sounds), and then push D-pad(Ent) to go to the next level.

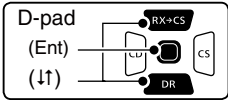

( MENU > Sounds > **Volume Select** )

- ③ Refer to the menu sequence shown directly above and push D-pad(↑) to select, and then push D-pad(Ent) to enter, one or more times until the last screen is displayed.
- ④ Push D-pad(↑) to select the desired option.
  - All : The audio output level for the BC Radio, A band and B band are adjusted at the same time.
  - BC Radio Separate : The audio output level for the BC Radio is independently adjusted. The audio output level for A band and B band are adjusted at the same time.
  - Separate : The audio output level for the BC Radio, A band and B band are independently adjusted.
- ⑤ Push [MENU]  to exit the Menu screen.

**When “All” or “BC Radio Separate” is selected:**

- Rotate [VOL] to adjust the audio level.
  - The audio output levels for A band and B band are adjusted at the same time:

**When “Separate” is selected:**

- ① Push [MAIN]  for 1 second to select A band or B band for the MAIN band.
- ② Rotate [VOL] to adjust the audio level.
  - When the audio output level for A band and B band are independently adjusted. For example, even if the audio output level for A band is adjusted, B band’s audio level stays at the original level.

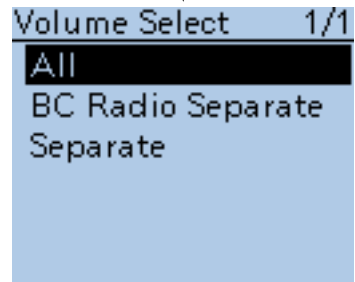
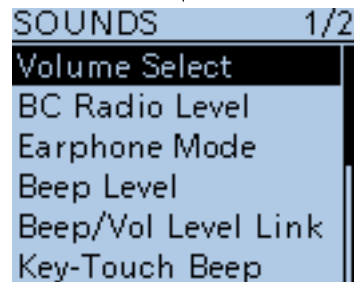
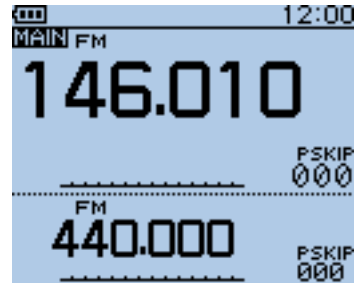
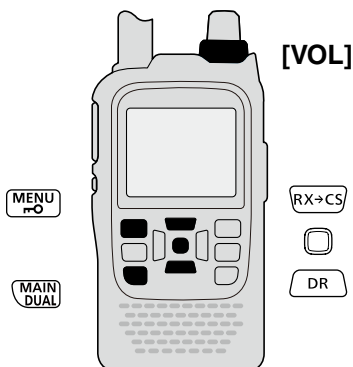



## Weather channel operation (U.S.A. version transceivers only)

There are 10 weather channels for monitoring weather channels from the NOAA (National Oceanographic and Atmospheric Administration) broadcasts.

### Weather channel selection

- ① Push [M/CALL] <sup>[M/CALL]</sup><sub>[S.MVV]</sub> one or more times to select the weather channel mode.
  - “WX” and the weather channel number appear.
- ② Rotate [DIAL] to select the desired weather channel.
- ③ Push [V/MHz] <sup>[V/MHz]</sup><sub>[CLR LOW]</sub> or [M/CALL] <sup>[M/CALL]</sup><sub>[S.MVV]</sub> to return to the previous frequency or Memory channel.

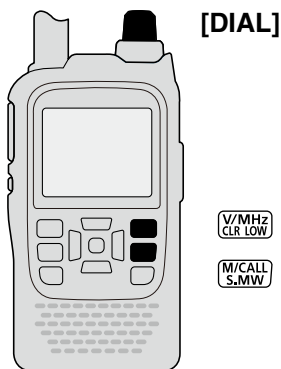

Weather channel mode

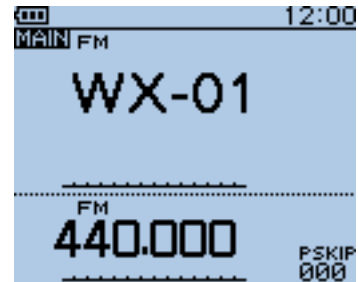

### Weather alert function

NOAA broadcast stations transmit weather alert tones before important weather announcements.

When the weather alert function is turned ON, the selected weather channel is monitored every 5 seconds for the announcement.

When the alert signal is detected, the “ALT” and the WX channel are alternately displayed, and a beep tone sounds until the transceiver is operated.

The previously selected (used) weather channel is checked periodically during standby or while scanning.

- ① Push [QUICK] <sup>[QUICK]</sup><sub>[SPCH]</sub> to open the Quick Menu screen.
- ② Push D-pad(↑) to select “Weather Alert,” and then push D-pad(Ent).

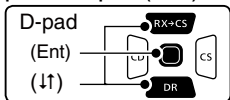

- ③ Push D-pad(↓) to select “ON” or “OFF.”
- ④ Push D-pad(Ent) to save the setting and exit the Quick Menu screen.
- ⑤ Set the desired standby mode.
  - “WX” appears when “ON” is selected in step ③.
  - Select the VFO, a Memory or Call channel.
  - Scan or priority watch operation can also be selected.

When the alert signal is detected

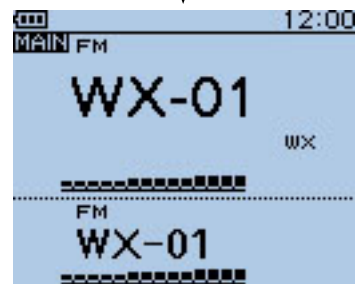

- Basic operation..... 6-2
  - ◇ Descriptions..... 6-2
  - ◇ Turning ON the BC Radio..... 6-2
  - ◇ Listening to the BC Radio while monitoring two ham bands..... 6-3
  - ◇ Mode selection ..... 6-3
  - ◇ Bank selection on the Memory bank mode ..... 6-4
  - ◇ AM/FM radio mode selection..... 6-5
  - ◇ To searching the broadcast signal..... 6-5
  - ◇ Attenuator function ..... 6-6
  - ◇ Setting squelch level..... 6-7
  - ◇ Monitor function..... 6-7
  - ◇ Setting a tuning step (AM Only) ..... 6-8
- Adding or editing a BC Radio memory ..... 6-9
  - ◇ BC Radio Memory ..... 6-9
  - ◇ Add a BC Radio memory ..... 6-9
  - ◇ Deleting a BC Radio memory..... 6-12
  - ◇ Editing a BC radio memory ..... 6-13
  - ◇ Rearrange the display order of the BC Radio memory ..... 6-14
- Skip setting for the BC radio memory..... 6-15
- Using the BC Radio Mode..... 6-16
- BC Radio setting ..... 6-17
  - ◇ FM Antenna..... 6-17
  - ◇ Power Save (BC Radio)..... 6-17
  - ◇ Auto Mute ..... 6-18
  - ◇ Volume Select ..... 6-19
  - ◇ BC Radio Level..... 6-20



## Basic operation

### Descriptions

You can listen to the AM or FM Broadcast (BC) Radio. When the transceiver receives 2 amateur bands on the MAIN band and SUB band, you can still listen to the Broadcast (BC) Radio on the pop up window.

Up to 50 BC Radio memory channels can be programmed into each bank for easy memory management.

You can comfortably standby listening to the BC Radio. Also, the transceiver can be used as just a BC Radio. In this case, the other modes are in a sleep state.

The BC radio memory channel contents, described in this manual, may differ from your transceiver's pre-programmed memory.

Frequency range for the BC Radio	
FM	76.0 MHz* to 108.0 MHz
AM	520 kHz to 1710 kHz

\*The usable frequency range differs, according to the transceiver's version.



Example: While listening to FM-A Station

### Turning ON the BC Radio

- Push [QUICK] [QUICK SPCH].
- Push D-pad(↑) to select "<<BC Radio ON>>," and then push D-pad(Ent).

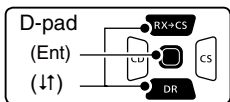

- The BC Radio pop up window appears, and exits the Quick Menu screen.
  - "BC" appears.

To turn OFF the BC Radio, push [QUICK] [QUICK SPCH], and then select "<<BC Radio OFF>>," as described above.

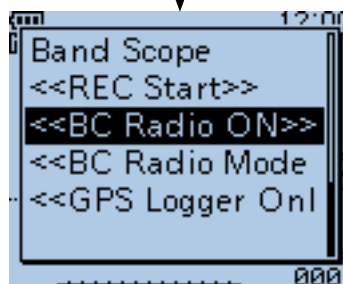
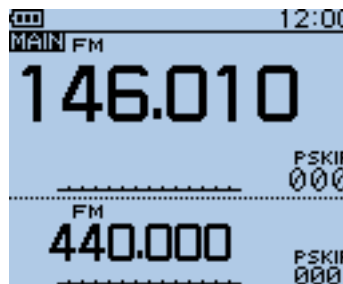
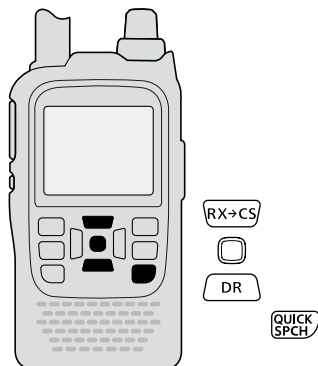

■ Basic operation (Continued)

◇ Listening to the BC Radio while monitoring two ham bands

When the transceiver receives 2 amateur bands on the MAIN band and SUB band, you can still listen to the BC Radio.

- ① Push [QUICK] [QUICK SPCH].
- ② Push D-pad(↑) to select “<<BC Radio ON>>,” and then push D-pad(Ent).

• “” appears.

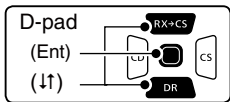

- ③ Push [CLR] [V/MHz CLR LOW] to turn OFF the BC Radio pop up window.
- You can comfortably standby listening to the BC Radio.

/// **NOTE:** To show the BC Radio pop up window again, push [QUICK] [QUICK SPCH], and push D-pad(↑) to select “<<BC Radio>>,” then push D-pad(Ent).

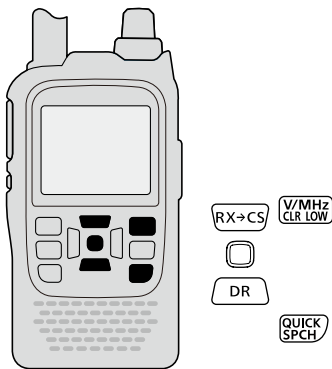

◇ Mode selection

- ① When the BC Radio pop up window is displayed, push [M/CALL] [M/CALL S.MW] to select between the Tuning mode and the Memory bank mode.
- ② Rotate [DIAL] to select the frequency or memory channel.

• Tuning mode

The BC Radio Tuning mode is used to set the desired BC Radio frequency. To save the selected frequency, hold down [S.MW] [M/CALL S.MW] for 1 second to program into the lowest memory channel of the selected bank.

• Memory bank mode

The BC Radio Memory bank mode is very useful to quickly select often-used frequency settings. When the Memory bank mode is selected, “MR” and the selected memory channel number appear.

/// **NOTE:** Push [QUICK] [QUICK SPCH], and select “VFO” to select the Tuning mode, or select “MR” to select the Memory bank mode.

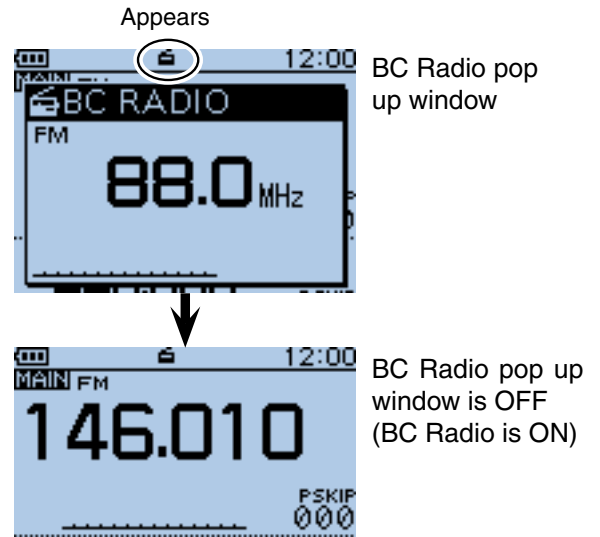

To show the BC Radio pop up window again, select “<<BC Radio>>.”

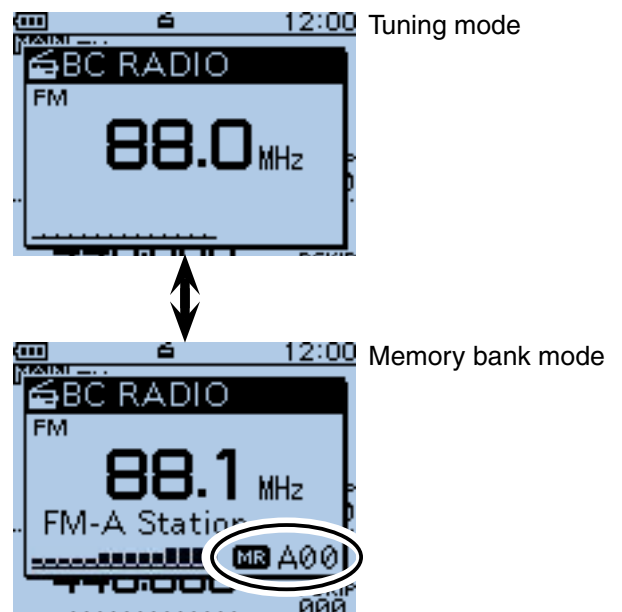

■ Basic operation (Continued)

◇ Bank selection on the Memory bank mode

Up to 50 BC Radio memory channels can be programmed into each bank for easy memory management.

If you switch the bank, other area channel can be selected.

① Push [M/CALL] <sup>[M/CALL S,MW]</sup> to select the Memory bank mode.

- "MR" and the selected memory channel number appear.

② Push [QUICK] <sup>[QUICK SPCH]</sup>.

② Push D-pad(↓) to select "Bank Select," and then push D-pad(Ent).

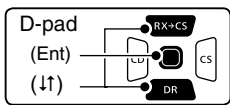

③ Push D-pad(↓) to select the desired bank, and then push D-pad(Ent).

④ The memory channel of the selected bank appears, and exits the Quick Menu screen.

- Rotate [DIAL] to select a memory channel.
- Push [MODE] <sup>[MODE SCAN]</sup> to select the FM or AM mode.

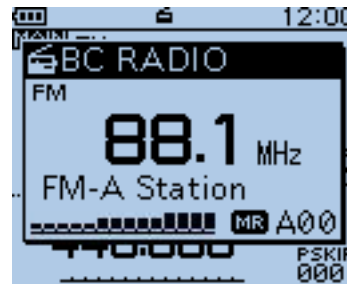
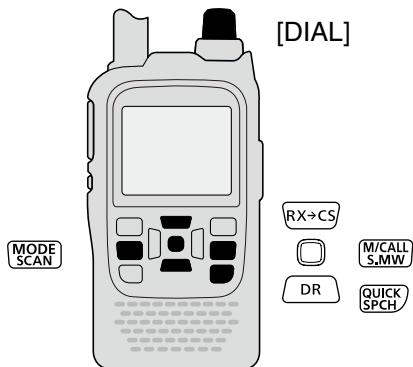

Memory bank mode (Bank A)

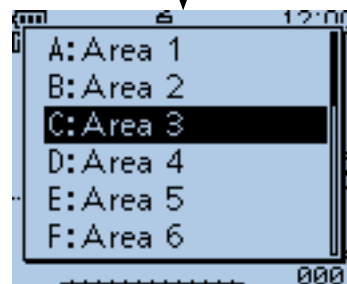
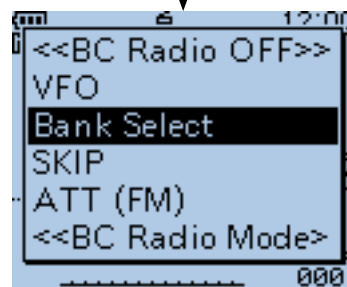

Select "Bank C"



The preprogrammed channel of Bank C is displayed

## 6 BC RADIO OPERATION

### ■ Basic operation (Continued)

#### ◇ AM/FM radio mode selection

➔ Push [MODE] <sup>(MODE)</sup> <sub>(SCAN)</sub> to select the AM or FM radio mode.

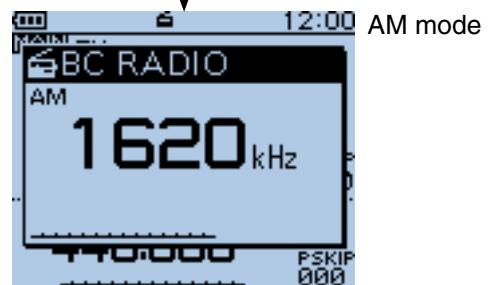
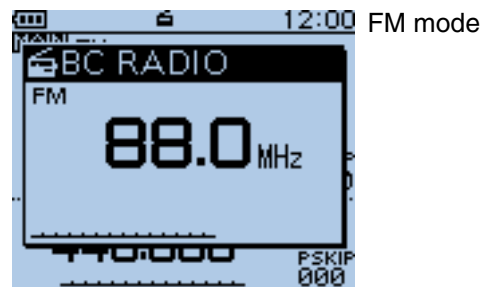
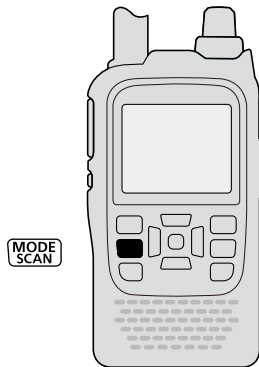

#### ◇ To searching the broadcast signal

While in the Tuning mode, hold down **[CD]** or **[CS]** to start searching the broadcast signal.

- When **[CD]** is held down, a down scan starts, and when **[CS]** is held down, up scan starts.
- When a signal is received, the scanning stops on the frequency.
- To cancel scanning, push **[CD]**, **[CS]** or **[CLR]** <sup>(V/MHz)</sup> <sub>(CLR LOW)</sub>.

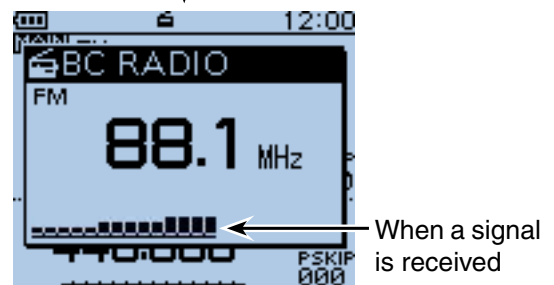
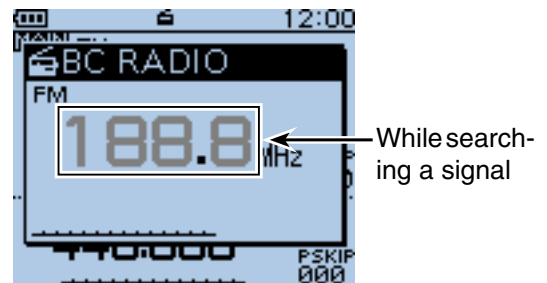
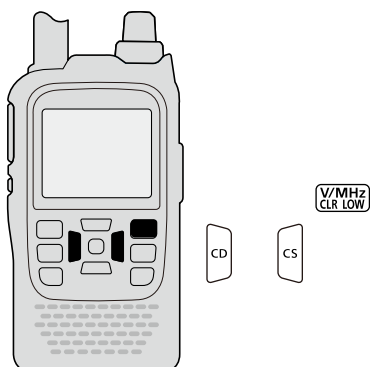



■ Basic operation (Continued)

◇ Attenuator function

The attenuator reduces signal levels to prevent audio distortion.

This is useful when the transceiver receives a very strong AM or FM BC Radio signal, or it is in very strong electromagnetic fields such as from a broadcasting station near your location.

The attenuator can be set in both the AM and FM mode.

- ① Push [MODE]  to select the desired AM or FM mode.
- ② Push [QUICK] .
- ③ Push D-pad(↑) to select "ATT (FM)," and then push D-pad(Ent).

- When the AM mode is selected in step ①, select "ATT (AM)."

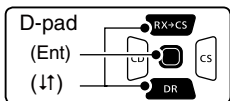

- ④ Push D-pad(↑) to select the attenuator.
  - **ATT (FM)**  
 OFF : The attenuator is OFF.  
 30dB : The attenuation is about 30 dB.
  - **ATT (AM)**  
 OFF : The attenuator is OFF.  
 Auto : The attenuation is automatically switched between OFF and 30 dB (maximum), depending on the received signal strength level.  
 30dB : The attenuation is set to 30 dB.  
 50dB : The attenuation is set to 50 dB.
- ⑤ Push D-pad(Ent) to save, and exit the Quick Menu screen.
  - When the attenuator is ON, "ATT" appears on the BC Radio pop up window.

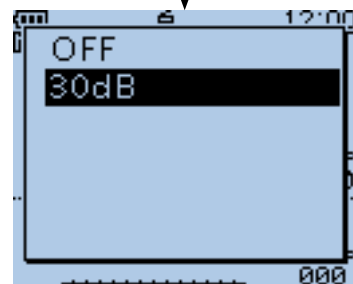
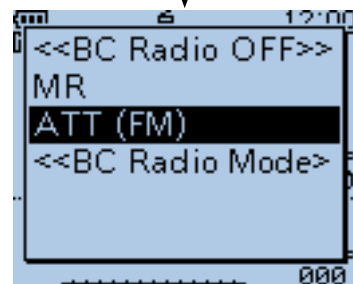
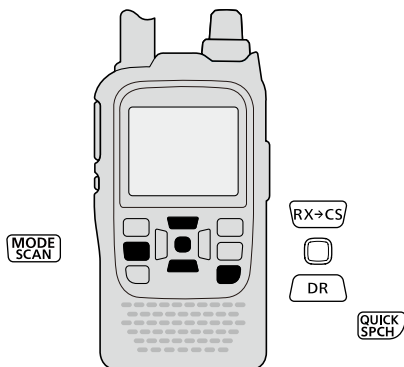

Appears

■ Basic operation (Continued)

◇ **Setting squelch level**

The squelch level can be set only for the BC radio.

- ① While holding down [SQL], rotate [DIAL] one click to display the squelch level. (Default: AUTO)
- ② While holding down [SQL], rotate [DIAL] to select the squelch level.
  - “LEVEL1” is loose squelch (for weak signals) and “LEVEL3” is tight squelch (for strong signals).
  - “AUTO” shows automatic level adjustment by a noise pulse counting system.
  - “OPEN” shows a continuously open setting.

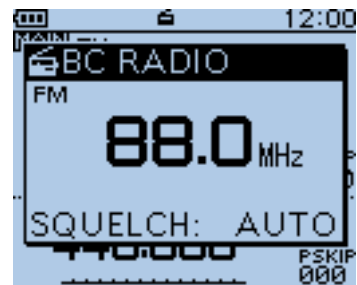

When “AUTO” is selected.

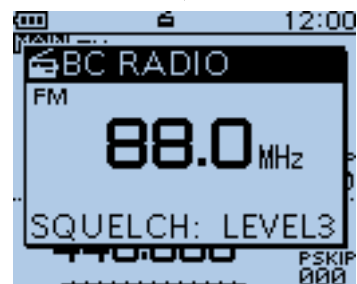

When Level 3 (Maximum) is selected.

◇ **Monitor function**

This function is used to listen to weak BC Radio signals without disturbing the squelch setting, or having to manually open the squelch.

- ➔ Hold down [SQL] to monitor the operating frequency.
  - The 1st segment of the S-meter blinks.

The [SQL] key can be set to ‘sticky’ operation in Function menu.

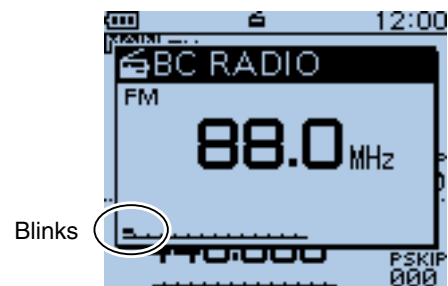

MENU > Function > **Monitor** (p. 16-66)



■ Basic operation (Continued)

◇ **Setting a tuning step (AM Only)**

If you select the BC Radio frequency by rotating [DIAL] in the Tuning mode, the frequency changes in the selected tuning step.

- ① Push [MODE]  to select the AM mode.
- ② Push [QUICK] .
- ③ Push D-pad(↑) to select "TS," and then push D-pad(Ent).

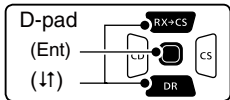

- ④ Push D-pad(↑) to select the desired tuning step between 1.0 kHz, 9.0 kHz and 10.0 kHz.
- ⑤ Push D-pad(Ent) to save, and exit the Quick Menu screen.

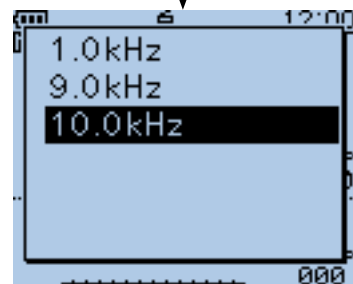
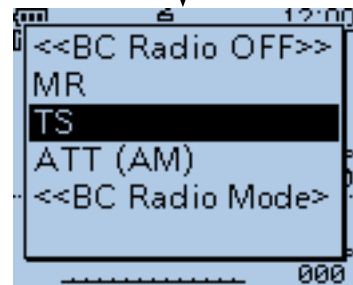
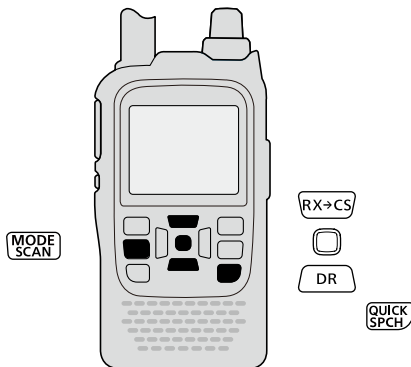

When 10.0 kHz step is selected.

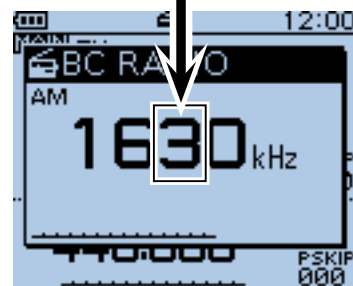

The frequency changes in the selected tuning step.

## ■ Adding or editing a BC Radio memory

### ◇ BC Radio Memory

A total of 26 banks are selectable for BC Radio Memory. You can assign up to 50 BC Radio memory channels to each bank, for easy memory management. (A maximum of 500 memories can be assigned to the BC Radio Memory.)

Some area stations are preloaded into the BC Radio memory for easy memory management.

▨ The BC radio memory channel contents, described in this manual, may differ from your transceiver's pre-programmed memory.

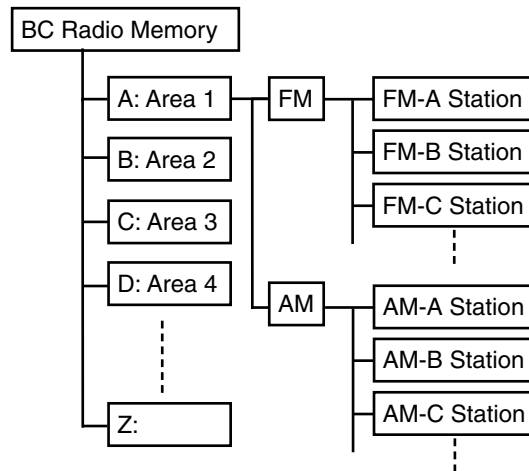

(Example)

### ◇ Add a BC Radio memory

#### 1. Adding a BC Radio Memory and entering the edit mode

- 1 Push [MENU] .
- 2 Push D-pad(↑) to select the root item (“BC Radio”), and then push D-pad(Ent).

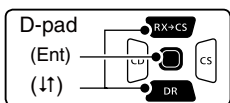

- 3 Push D-pad(↑) to select a desired bank, and then push D-pad(Ent).
- 4 Push D-pad(↑) to select the desired radio mode (AM or FM) to be programmed.
- 5 Push [QUICK] .
- 6 Push D-pad(↑) to select “Add,” and then push D-pad(Ent).
  - The BC RADIO MEM EDIT screen is displayed.

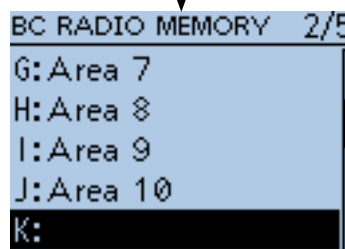
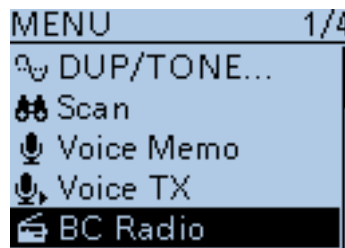

BC RADIO MEMORY screen is displayed.



When no memory is programmed, “-- Blank --” appears.



Select “Add”

☞ Continued on the next page



■ Adding or editing BC Radio memory (Continued)

2. BC Radio Memory name programming

7 Push D-pad(↓) to select "NAME," and then push D-pad(Ent).

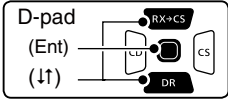

- 8 Rotate [DIAL] to select the first character.
- Selectable input characters are Upper case letters, Lower case letters, Numbers or Symbols.
  - The selected character blinks.
  - Push D-pad(←) to move the cursor backward or forward.
  - While selecting a character, push [QUICK] [QUICK] [SPCH] to change the character to an upper case or lower case letter.
  - While selecting a digit, push [QUICK] [QUICK] [SPCH] to open the input mode selection window.
  - A space can be entered, in any input mode selected.
  - Rotate [DIAL] counter clockwise to enter a space.
  - Push [CLR] [V/MHz] [CLR LOW] to delete the selected character, or hold down [CLR] [V/MHz] [CLR LOW] to continuously delete the characters, first to the right, and then to the left of the cursor.
  - See page 2-7 for programming details.
- 9 Push D-pad(→) to move the cursor to the second digit.
- 10 Repeat steps 8 and 9 to enter a BC Radio Memory name of up to 16 characters, including spaces.
- 11 After entering the name, push D-pad(Ent).

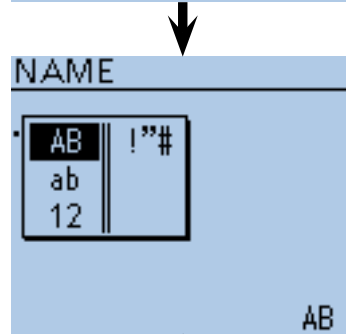
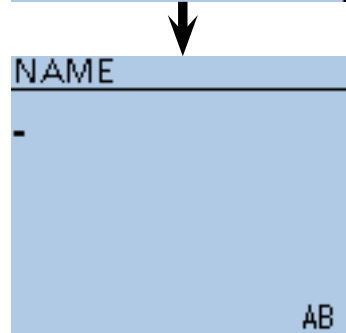
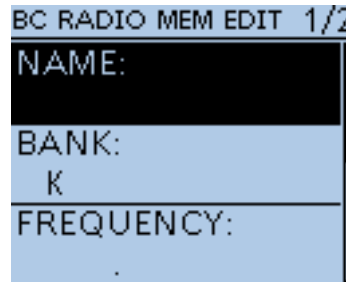

Character type selection screen

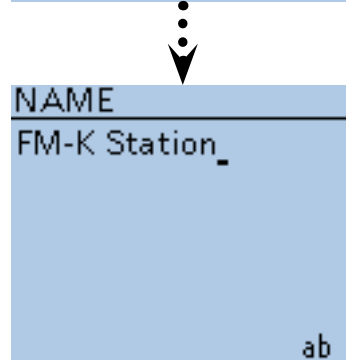

(Example) When entering "FM-K Station"

➡ Continued on the next page

■ Adding or editing BC Radio memory (Continued)

3. Frequency programming

- 12 Push D-pad(↓) to select “FREQUENCY;” and then push D-pad(Ent).
  - A cursor appears and blinks.

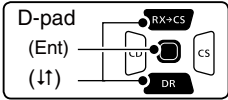

- 13 Rotate [DIAL] to input the frequency.
  - AM: 520 to 1710 kHz
  - FM: 76.0 to 108.0 MHz
- 14 Push D-pad(←) to move the cursor backward or forward to edit the frequency.
- 15 Repeat steps 13 and 14 to enter the frequency.
- 16 After entering, push D-pad(Ent).

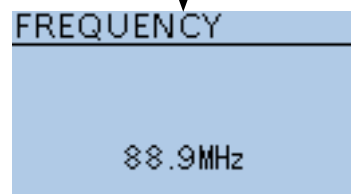
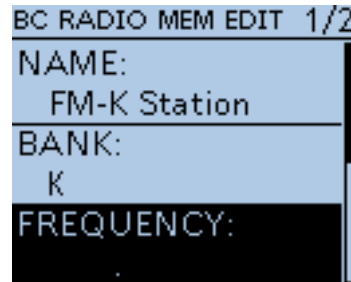

(Example)  
When entering  
“88.9”

4. Skip setting

- 17 Push D-pad(↓) to select “SKIP;” and then push D-pad(Ent).
- 18 Push D-pad(↓) to select whether or not to use the channel in the BC Radio memory.
  - OFF: You can select the channel in the BC Radio memory.
  - Skip: The channel does not appear in the BC Radio memory.
- 19 After selecting, push D-pad(Ent).

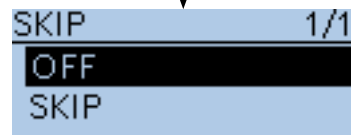
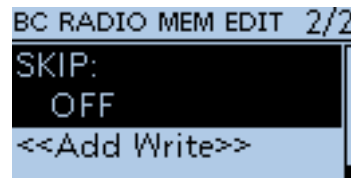

5. Writing BC Radio Memory

- 20 Push D-pad(↓) to select “<<Add Write>>,” and then push D-pad(Ent).
  - If a previously added BC Radio memory is edited, select “<<Overwrite>>.”
- 21 Push D-pad(1) to select “YES;” and then push D-pad(Ent).

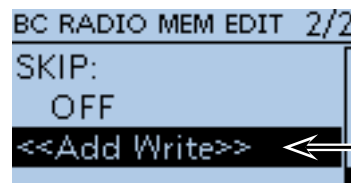

Select

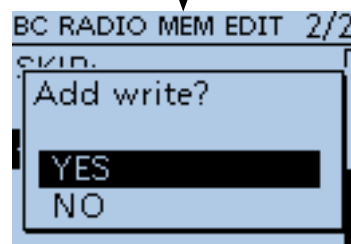

(Example)  
When “FM-K Station” is  
programmed in Bank K.

The list of BC Radio Bank K  
is displayed.

**To cancel the programmed data:**

- 1 To cancel the programmed data, push [CLR] (CLR LOW) to display “Cancel edit?”
- 2 Push D-pad(1) to select “YES;” and then push D-pad(Ent) to cancel programming and return to the BC Radio Memory’s channel list screen.

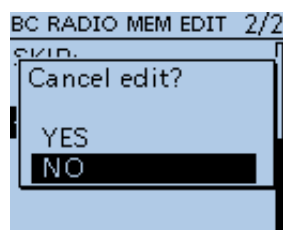

■ Adding or editing BC Radio memory (Continued)

◇ **Deleting a BC Radio memory**

All the contents of a BC Radio memory can be deleted.

Please note that deleted memory cannot be restored.

- ① Push [MENU] .
- ② Push D-pad(↓) to select the root item (BC Radio), and then push D-pad(Ent).

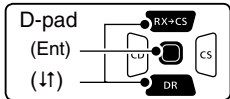

- ③ Push D-pad(↓) to select “BC Radio Memory,” and then push D-pad(Ent).
- ④ Push D-pad(↓) to select the BC Radio group that includes the memory you want to delete, and then push D-pad(Ent).
- ⑤ Push D-pad(↓) to select the memory channel to be deleted.
- ⑥ Push [QUICK] .
- ⑦ Push D-pad(↓) to select “Delete,” and then D-pad(Ent).
- ⑧ Push D-pad(↑) to select “YES,” and then push D-pad(Ent).
  - The selected BC Radio memory is deleted.

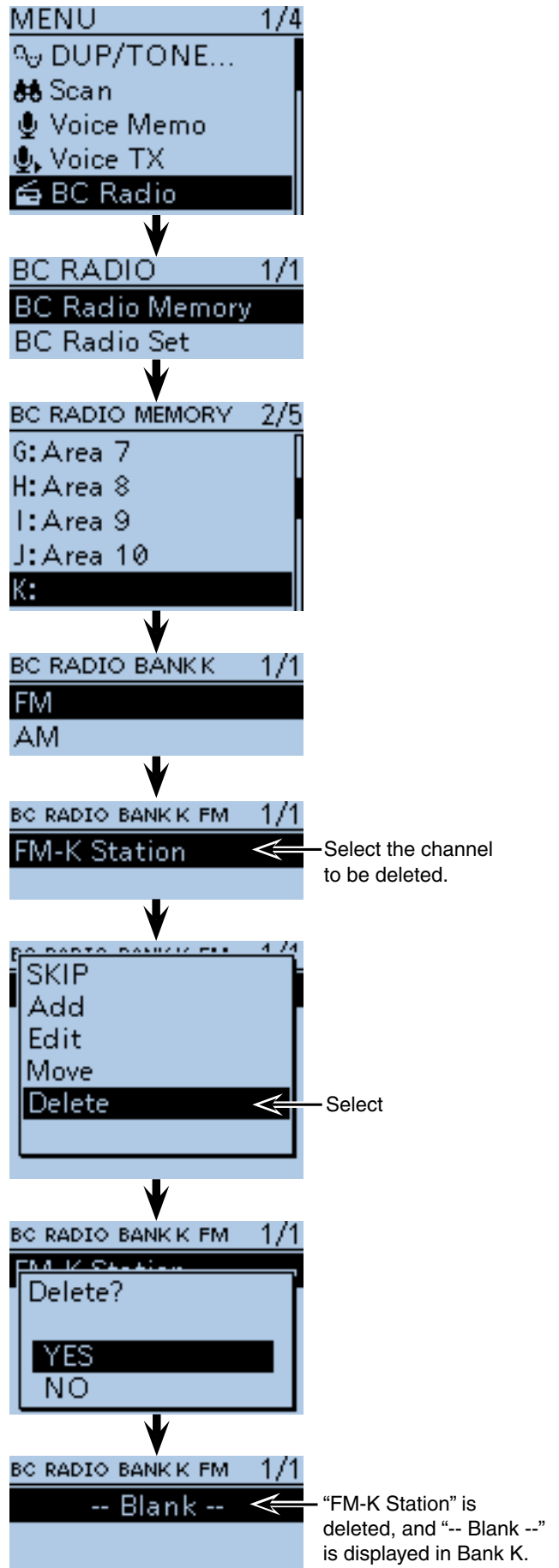



■ Adding or editing BC Radio memory (Continued)

◇ **Editing a BC radio memory**

This function reprograms a BC radio memory data. This is useful when already-programmed data is incorrect, has changed or some data should be added to the list.

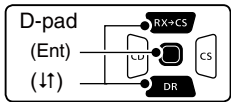
- ① Push [MENU] .
- ② Push D-pad(↑) to select the root item (“BC Radio”), and then push D-pad(Ent).



- ③ Push D-pad(↑) to select “BC Radio Memory,” and then push D-pad(Ent).
- ④ Push D-pad(↑) to select the BC Radio bank that includes the memory you want to edit, and then push D-pad(Ent).
- ⑤ Push D-pad(↑) to select the memory to be edited.
- ⑥ Push [QUICK] .
- ⑦ Push D-pad(↑) to select “Edit.”
- ⑧ Push D-pad(↑) to select the desired item, and then push D-pad(Ent).
  - See pages 6-9 to 6-11 for programming details.
- ⑨ After programming, the display returns to the BC RADIO MEM EDIT screen.
- ⑩ Push D-pad(↓) to select “<<Overwrite>>,” and then push D-pad(Ent).
- ⑪ Push D-pad(↓) to select “YES,” and then push D-pad(Ent).
  - The programmed contents are overwritten in the BC radio memory, and the transceiver returns to the BC Radio bank screen.

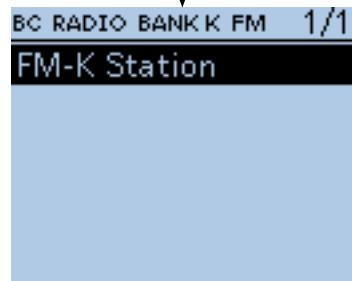
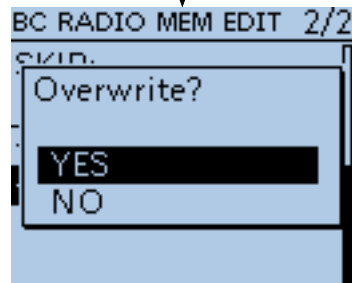
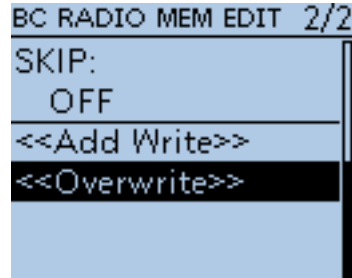

Example:  
“FM-K Station”  
is edited.

■ Adding or editing BC Radio memory (Continued)

◇ Rearrange the display order of the BC Radio memory

You can move the programmed BC Radio memory to rearrange their display order in the selected BC Radio memory bank.

The programmed BC Radio memory cannot be moved out of their assigned memory bank.

- ① Push [MENU] .
- ② Push D-pad(↑) to select the root item ("BC Radio"), and then push D-pad(Ent).

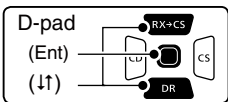

- ③ Push D-pad(↓) to select "BC Radio Memory," and then push D-pad(Ent).
- ④ Push D-pad(↑) to select the BC Radio memory bank that includes the BC Radio memory you want to move, and then push D-pad(Ent).
- ⑤ Push D-pad(↑) to select the BC Radio memory to be moved.
- ⑥ Push [QUICK] .
- ⑦ Push D-pad(↑) to select "Move," and then push D-pad(Ent).
  - "DESTINATION" blinks on the upper left of the LCD.
- ⑧ Push D-pad(↑) to select the location to insert the memory you want to move, which will be above the memory name selected in this screen, and then push D-pad(Ent).
  - The selected memory contents are inserted to above the destination memory name.
  - When "<<Move End>>" is selected, the selected memory contents are moved to the bottom of the BC Radio memory bank.

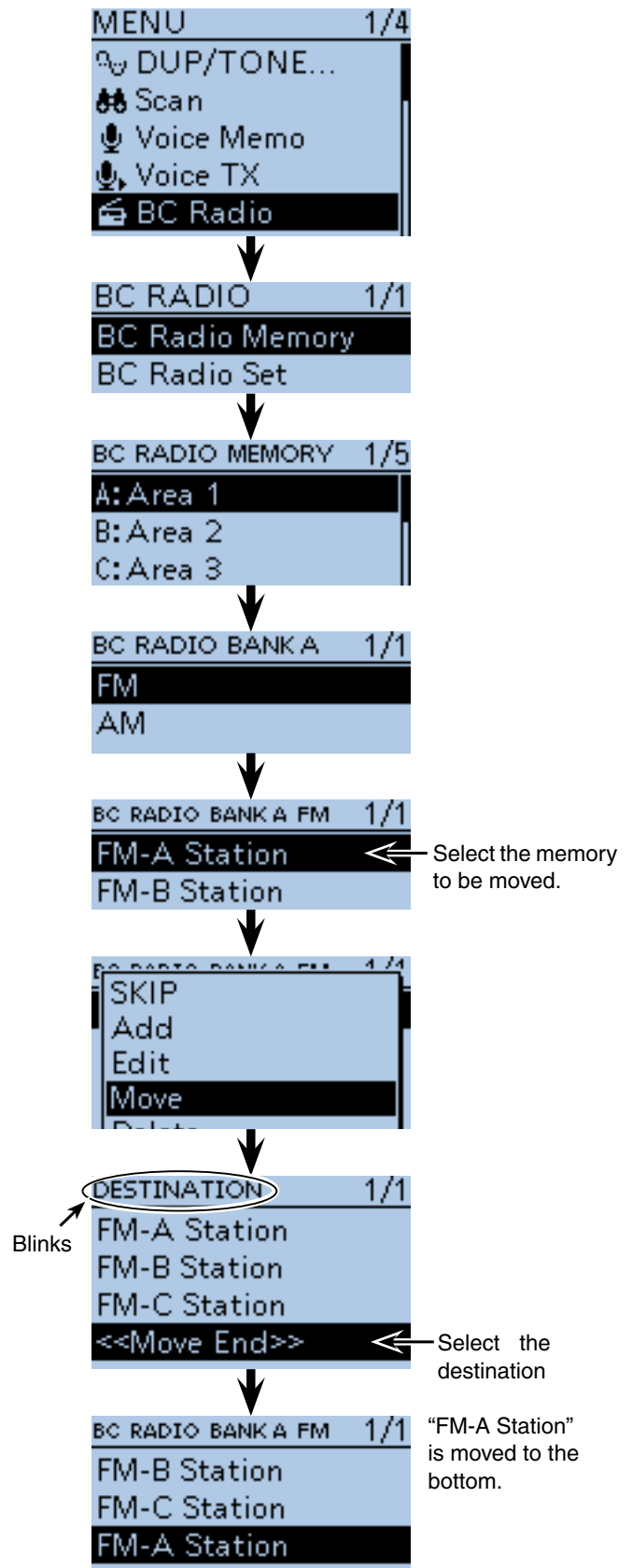



## ■ Skip setting for the BC radio memory

You can set the undesired frequency to skip targets.

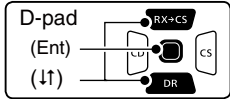
- ① Push [MENU] .
- ② Push D-pad(↑) to select the root item (“BC Radio”), and then push D-pad(Ent).



- ③ Push D-pad(↑) to select “BC Radio Memory,” and then push D-pad(Ent).
- ④ Push D-pad(↑) to select the BC Radio memory bank that includes the BC Radio memory you want to set the skip setting on, and then push D-pad(Ent).
- ⑤ Push D-pad(↑) to select the BC Radio memory to be skipped.
- ⑥ Push [QUICK] .
- ⑦ Push D-pad(↑) to select “SKIP,” and then push D-pad(Ent).
  - “SKIP” appears on the selected **repeater**.
  - Push [QUICK]  and select “SKIP” again, then push D-pad(Ent) to cancel the skip setting.

In the BC radio window, push [QUICK] , and select “SKIP” also set the skip setting.

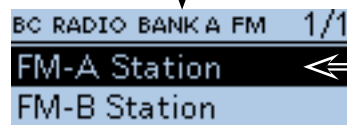
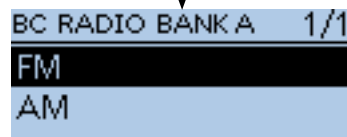
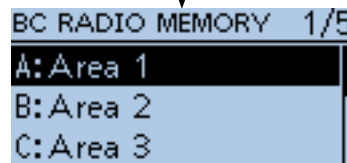
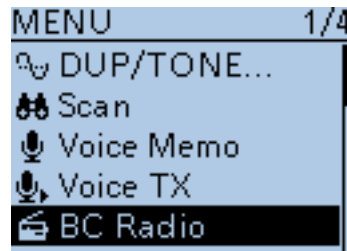
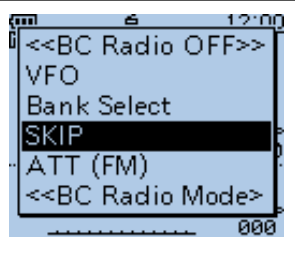

Select the memory to be skipped.

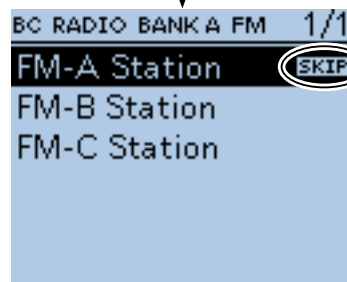
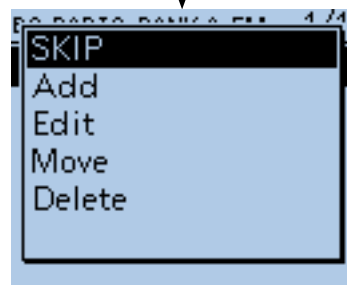

Appears

## ■ Using the BC Radio Mode

The transceiver has an exclusive BC Radio mode where only the BC Radio functions.

- ① Push [QUICK]<sup>QUICK</sup><sub>SPCH</sub>.
- ② Push D-pad(↑) to select “<<BC Radio Mode>>,” then push D-pad(Ent).

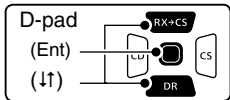

- BC radio mode screen is displayed.

To cancel the BC Radio mode, push [QUICK]<sup>QUICK</sup><sub>SPCH</sub>, and select “<<Normal Mode>>.”

In the exclusive BC Radio mode, the other modes are in a sleep state.

To operate the transceiver in a normal way, push [QUICK]<sup>QUICK</sup><sub>SPCH</sub>, and then select “<<Normal Mode>>.”

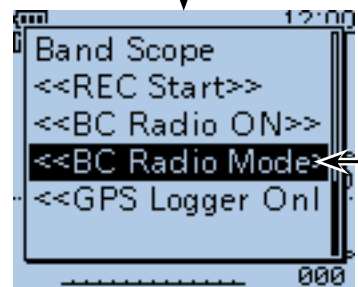
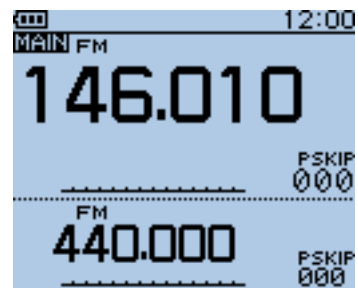

BC Radio Mode screen

## ■ BC Radio setting

### ◇ FM Antenna

Select the desired antenna for FM radio.

- ① Push [MENU] .
- ② Push D-pad(↑) to select the root item (“BC Radio”), and then push D-pad(Ent) to go to the next screen.

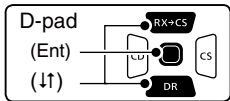

(MENU > BC Radio > BC Radio Set> **FM Antenna**)

- ③ Refer to the menu sequence shown directly above and push D-pad(↑) to select, and then D-pad(Ent) to enter, one or more times until the last screen is displayed.
- ④ Push D-pad(↑) to select the desired antenna used for the FM radio
  - External : The external antenna is used.
  - Earphone : The earphone antenna is used.
- ⑤ Push [MENU]  to exit the MENU screen.

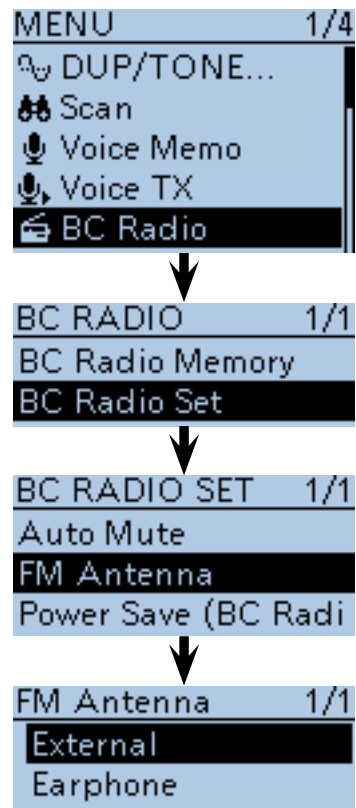

### ◇ Power Save (BC Radio)

Set the power save function to reduce current drain and conserve battery power when the BC Radio is ON.

- ① Push [MENU] .
- ② Push D-pad(↑) to select the root item (“BC Radio”), and then push D-pad(Ent) to go to the next screen.

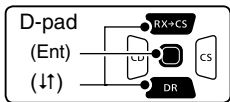

(MENU > BC Radio > BC Radio Set> **Power Save (BC Radio)**)

- ③ Refer to the menu sequence shown directly above and push D-pad(↑) to select, and then D-pad(Ent) to enter, one or more times until the last screen is displayed.
- ④ Push D-pad(↑) to set the power save function when the BC Radio is ON.
  - OFF : The power save function is OFF.
  - ON : When the BC Radio is ON, and when no signal is received for 5 seconds, this function is activated in a 1:3 ratio (300 milliseconds: 900 milliseconds) during FM mode operation, or 1:1 ratio (2000 milliseconds: 2000 milliseconds) during AM mode operation.
- ⑤ Push [MENU]  to exit the MENU screen.

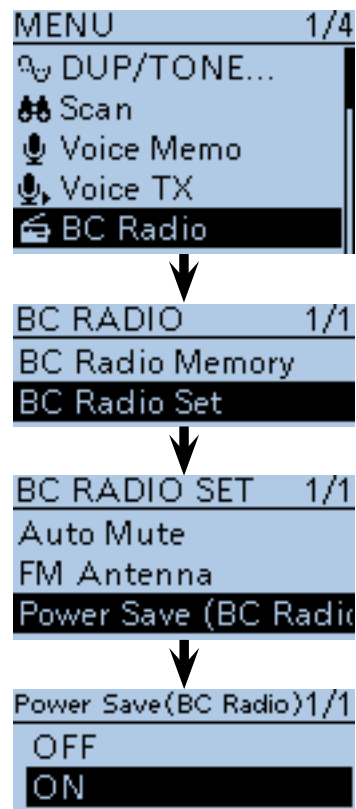

**NOTE:** This function is disabled when the external power supply is used.



■ BC Radio setting (Continued)

◇ **Auto Mute**

This setting is enabled when you listen to the BC Radio in the background.

- ① Push [MENU] .
- ② Push D-pad(↓) to select the root item (“BC Radio”), and then push D-pad(Ent) to go to the next screen.

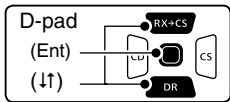

(MENU > BC Radio > BC Radio Set > **Auto Mute**)

- ③ Refer to the menu sequence shown directly above and push D-pad(↓) to select, and then D-pad(Ent) to enter, one or more times until the last screen is displayed.
- ④ Push D-pad(↓) to select the Auto Mute timer to between 0 and 10 seconds (in 1 second steps), or OFF.
  - OFF : The Auto Mute function is OFF. The BC Radio audio is not muted even if the transceiver receives a signal on the MAIN or SUB band. The BC Radio audio is muted when the transceiver transmits.
  - 0 to 10sec: The BC Radio audio is automatically muted when the transceiver transmits or receives on the MAIN or SUB band. After transmitting or receiving, the Auto Mute timer starts. After the timer period ends, you can listen to the BC Radio.
- ⑤ Push [MENU]  to exit the MENU screen.

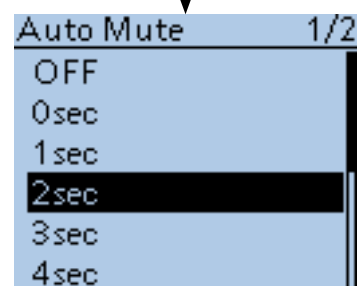
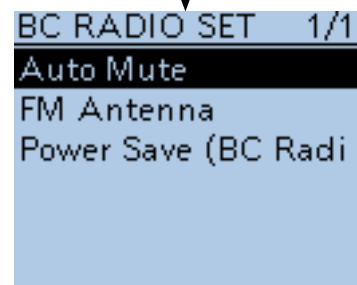
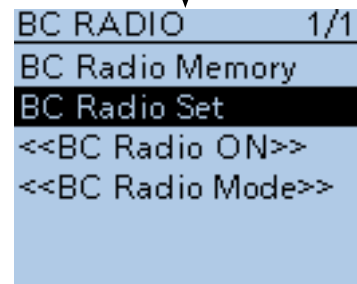
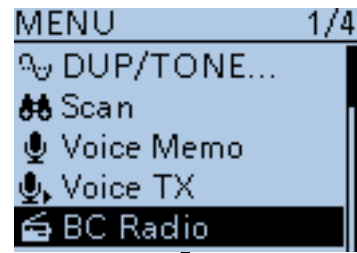



■ BC Radio setting (Continued)

◇ **Volume Select**

Select to adjust the audio output level of all bands together, all separately, or just the BC Radio separately.

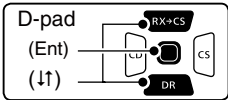
- ① Push [MENU] .
- ② Push D-pad(↑) to select the root item (“Sounds”), and then push D-pad(Ent).



- ③ Push D-pad(↑) to select “Volume Select,” and then push D-pad(Ent).
- ④ Push D-pad(↑) to select whether or not to independently adjust the audio output level.
  - All : The audio output level of the BC Radio, A band and B band are adjusted at the together.
  - BC Radio Separate : The audio output level of the BC Radio is separately adjusted. The audio output level of A band and B band are adjusted together.
  - Separate : The audio output level of the BC Radio, A band and B band are separately adjusted.
- ⑤ Push [MENU]  to exit the MENU screen.

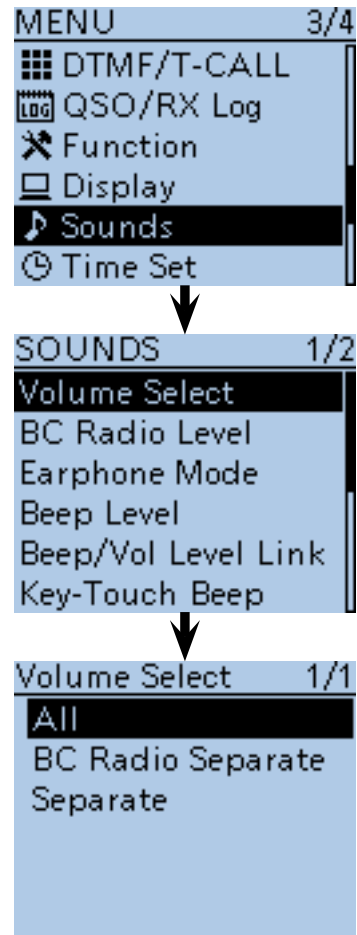



■ BC Radio setting (Continued)

◇ **BC Radio Level**

Set the initial audio output level difference between the BC Radio and the A and B bands when “All” is set in “Volume Select.” (p. 16-78)

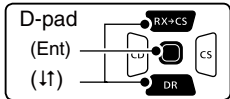
- ① Push [MENU] .
- ② Push D-pad(↑) to select the root item (“Sounds”), and then push D-pad(Ent).



- ③ Push D-pad(↓) to select “BC Radio Level,” and then push D-pad(Ent).
- ④ Rotate [DIAL] to adjust.
  - +5 to +1 : The BC Radio audio output level is higher than the A and B bands audio.
  - 0 : The BC Radio audio output level is same as the A and B bands audio.
  - -1 to -5 : The BC Radio audio output level is lower than the A and B bands audio.
- ⑤ Push [MENU]  to exit the MENU screen.

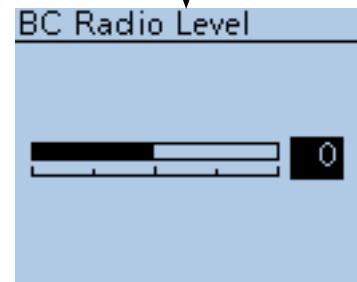
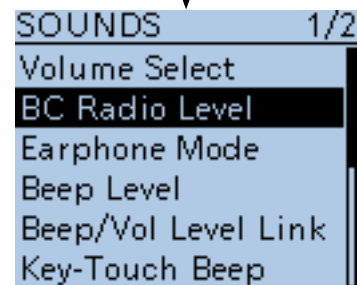

- D-STAR Introduction..... 7-2
- About the DR (D-STAR Repeater) mode..... 7-2
- Communication Form in the DR mode ..... 7-3

### To begin the digital mode communication except in the DR mode

To begin the digital mode communication except in the DR mode, you can use the VFO mode, Memory mode and Call channel mode.

This manual describes focusing on the DR mode operation which can be set up easily, and if you want to use another mode, see the procedures as described to the right.

#### For a Local area call or Gateway call:

- ① Set the access **repeater's** frequency. (p. 15-2)
- ② Set the **frequency offset.** (p. 15-4)
- ③ Set the **Duplex** direction. (p. 15-5)
- ④ Set the call signs. (p. 16-48)

#### For a **Simplex** call:

- ① Set the operating frequency.
- ② Set the call sign. (p. 16-48)

### IMPORTANT!

- The repeater list, described in this manual, may differ from your transceiver's preloaded contents.
- Although Japanese repeaters are used in the setting examples, the Japanese repeater node (port) letters are different from other country's.

Be sure to add a repeater node letter as the 8th digit in the call sign field after a repeater call sign, according to the repeater frequency band, as shown below.

1200 MHz : A (B in Japan)

430 MHz : B (A in Japan)

144 MHz : C (no D-STAR repeaters in Japan)

Before starting D-STAR, the following steps are needed.

**IMPORTANT!** **STEP 1** Entering your call sign (MY) into the transceiver. → **STEP 2** Registering your call sign (MY) to a gateway repeater. → You have completed the steps!!

See the Basic Instruction (printed manual) for details.

## ■ D-STAR Introduction

- In the original D-STAR (Digital Smart Technologies for Amateur Radio) plan, JARL envisioned a system of **repeaters** grouped together into Zones.
- The D-STAR repeater enables you to call a HAM station in another area through the internet.
- The transceiver can be operated in the digital voice mode, including low-speed data operation, for both transmit and receive. It has a built-in GPS receiver to transmit and receive position data.

## ■ About the DR (D-STAR Repeater) mode

The DR (D-STAR Repeater) mode is one mode you can use for D-STAR repeater operation. In this mode, you can select the preprogrammed repeater or frequency in "FROM" (the access repeater or **simplex**), and UR call sign in "TO" (destination), as shown to the right.

**NOTE:** If the repeater, set to "FROM" (Access Repeater) has no Gateway call sign, you cannot make a gateway call.

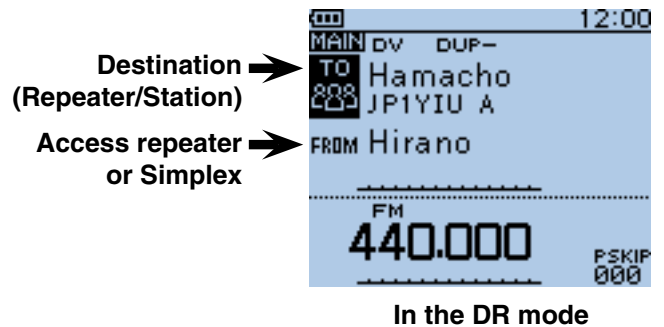

## ■ Communication Form in the DR mode

In the DR mode, the transceiver has three communication forms, as shown below.

- Local area call : To call through your local area (access) **repeater.**
- Gateway call : To call through your local area (access) repeater, repeater gateway and the internet to your destination repeater or individual station's last used repeater, using call sign routing.
- **Simplex** call : To call another station not using a repeater.

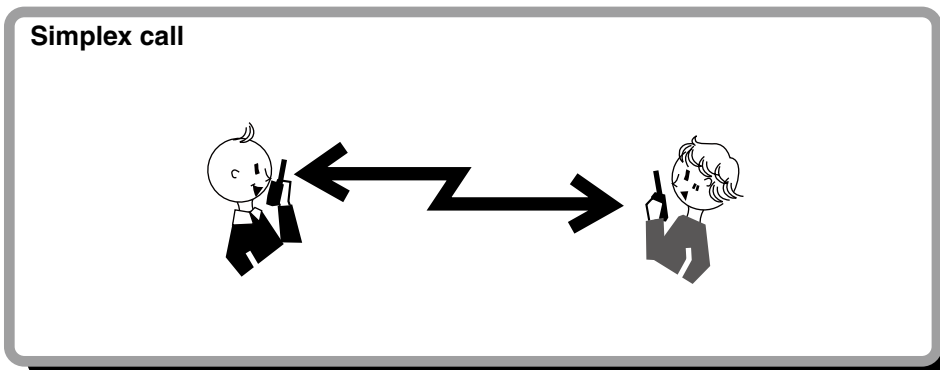
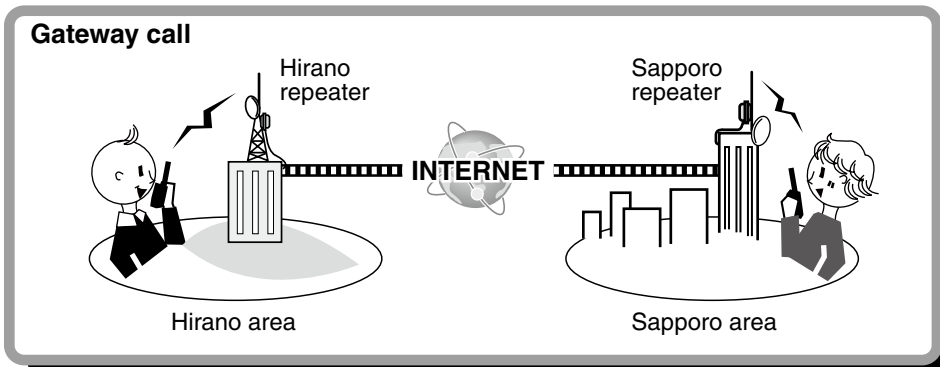
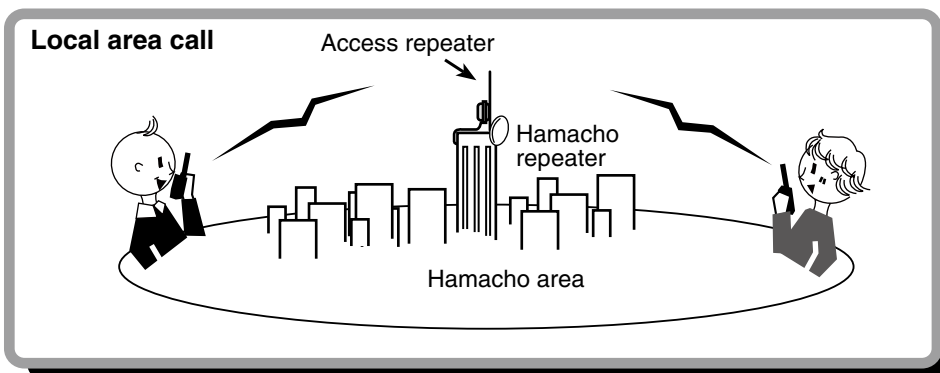

**NOTE:**

- Programming the repeater list is required for DR mode operation. (pp. 9-23 to 9-31)
- Before operating in the DV mode, be sure to check whether the repeater is busy, or not. If the repeater is busy, wait until it is clear, or ask for a “break” using a method acceptable to your local procedures.
- The transceiver has a Time-Out Timer function for digital repeater operation. The timer limits a continuous transmission to approximately 10 minutes. Warning beeps will sound approximately 30 seconds before time-out and then again immediately before time-out.

- “FROM” (Access repeater) setting..... 8-2
  - ◇ Using the preloaded repeater list ..... 8-3
  - ◇ Using the DR mode scan ..... 8-4
  - ◇ Using the Repeater Search function ..... 8-5
  - ◇ Using the TX History ..... 8-7
- “TO” (Destination) setting ..... 8-8
  - ◇ Using the “Local CQ” (Local Area call) ..... 8-9
  - ◇ Using the “Gateway CQ” (Gateway call) ..... 8-10
  - ◇ Using the “Your Call Sign” ..... 8-11
  - ◇ Using the RX History ..... 8-12
  - ◇ Using the TX History ..... 8-13
  - ◇ Directly inputting (UR) ..... 8-14
  - ◇ Directly inputting (RPT) ..... 8-15

### IMPORTANT!

- The **repeater** list, described in this manual, may differ from your transceiver’s preloaded contents.
- Although Japanese repeaters are used in the setting examples, the Japanese repeater node (port) letters are different from other country’s.

Be sure to add a repeater node letter as the 8th digit in the call sign field after a repeater call sign, according to the repeater frequency band, as shown below.

1200 MHz : A (B in Japan)

430 MHz : B (A in Japan)

144 MHz : C (no D-STAR repeaters in Japan)

## ■ “FROM” (Access repeater) setting

Your access **repeater** must be set to “FROM” when you transmit a call in the DR mode.

You have four ways to set the access repeater. Click the title shown below to jump to the specified page.

“Hirano”repeater → is set in “FROM.”



### • When you know your access repeater

#### From the repeater list (p. 8-3)

Select the repeater preloaded in your transceiver’s repeater list.\*

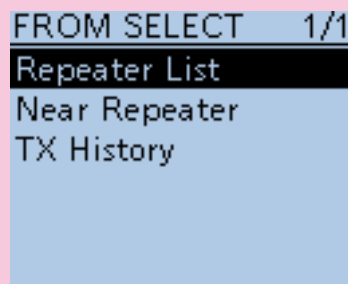

### • When you don't know which repeater you can access.

#### Search for a repeater using the DR mode scan (p. 8-4)

Searches for DV signals from a repeater or a **simplex** frequency.

Blinks →

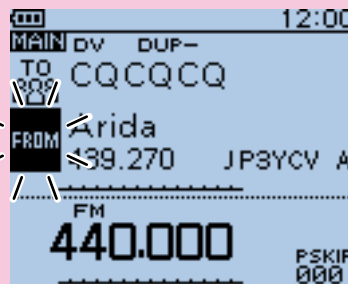

While DR mode scanning

#### Search for the nearest repeater (p. 8-5)

The transceiver searches the nearest repeater by using your own and the repeater’s position.

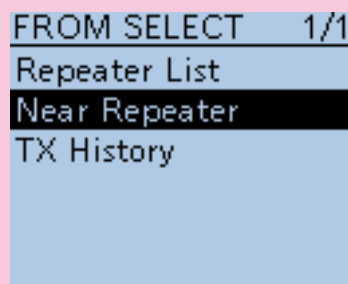

### • When the “FROM” data is stored in the TX History.

#### Setting from the TX History (p. 8-7)

When you transmit a call in the DR mode, “FROM” (the access repeater) data is stored in the TX History. You can select the access repeater from the record.

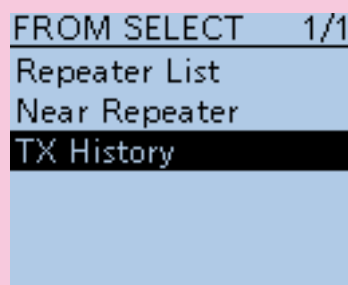



■ “FROM” (Access repeater) setting (Continued)

◇ Using the preloaded repeater list

For easy operation, the **repeater** list is preloaded into your transceiver.

- ① Hold down **DR** for 1 second.
  - The DR mode is selected.
- ② Push D-pad(↓) to select “FROM,” and then push D-pad(Ent).

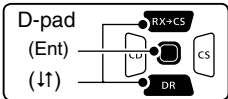

- ③ Push D-pad(↑) to select “Repeater List,” and then push D-pad(Ent).
- ④ Push D-pad(↑) to select the repeater group where your access repeater is listed, and then push D-pad(Ent).
  - Example: “11: Japan”
  - The repeater list, described in this manual, may differ from your transceiver’s preloaded list.
- ⑤ Push D-pad(↑) to select your access repeater, and then push D-pad(Ent).
  - Example: “Hirano”
- ⑥ If the selected repeater name is displayed in “FROM” on the DR mode screen, the access repeater setting is completed.

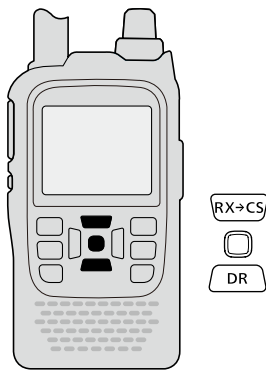

**Example:** Select the “Hirano” repeater in Japan from the repeater list.

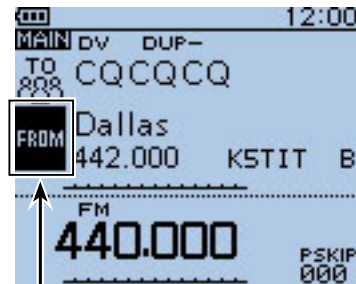

“FROM” is selected.

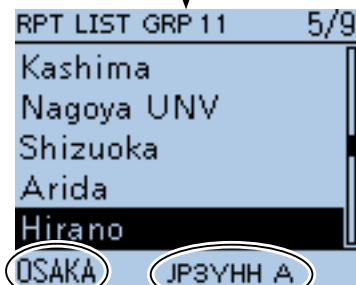
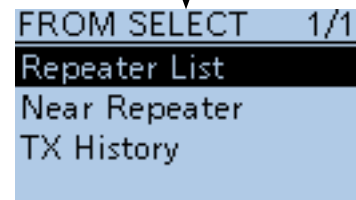

Repeater area      Repeater call sign



Completed

**How to switch the repeater group:**

- While in the DR mode, push **[QUICK] [QUICK SPCH]** to open the Quick menu. Then push D-pad(↑) to select “Group Select.”
  - You can switch the repeater group using D-pad(↑)

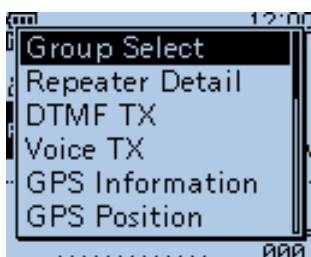

■ “FROM” (Access repeater) setting (Continued)

◇ Using the DR mode scan

The DR mode scan is useful to find a **repeater**. To quickly find a repeater, the DR mode scan skips repeaters that are not specified as an access repeater. (“USE (FROM)” setting is “NO” (SKIP is set) on the repeater list.)

- ① Hold down **DR** for 1 second.
  - The DR mode is selected.
- ② Hold down **[SCAN]**<sup>(MODE SCAN)</sup> to start the DR mode scan.
  - The frequency decimal point and “FROM” blink while scanning.
  - The repeaters in the repeater list are sequentially displayed.
  - The scan pauses when a signal is received. The scan resumes the same as other scanning. (p. 16-18)
- ③ When the transceiver receives a signal from a repeater, the scan stops, then push **[CLR]**<sup>(V/MHz CLR LOW)</sup>.
  - The DR mode scan is cancelled.

/// You can skip certain repeaters from a scan target.  
 /// You can also skip all repeaters in certain groups from a scan. See page 9-37 for details.

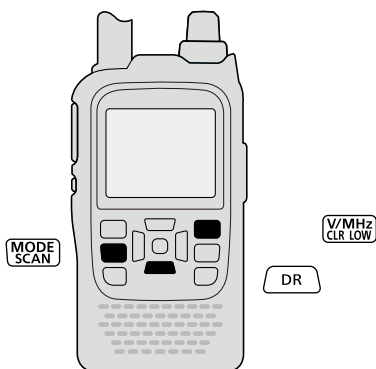

**NOTE:**  
 /// Even if the transceiver receives a signal from a repeater, the repeater may not receive the transceiver's signal, because the repeater's output power is higher than the transceiver's.

The DR mode scan scans **simplex** frequencies if they are entered in the repeater list.

**Example:** Select the “Hirano repeater using the DR mode scan.

“FROM” is selected.

The repeaters are sequentially displayed.

While DR mode scanning  
Blinks

Means “JM1ZLK” is using the “Hirano” repeater.

While receiving a signal from a repeater

Completed

■ “FROM” (Access repeater) setting (Continued)

◇ Using the Repeater Search function

The transceiver searches for the nearest **repeater** by using your own and repeater’s position data.

1. Receiving your own position data from the GPS receiver

When it is difficult to receive signals indoors, even if you are near a window, try going outdoors for better reception.

- ① Push [MENU] .
- ② Push D-pad(↑) to select the root item (“GPS”), and then push D-pad(Ent) to go to the next level.

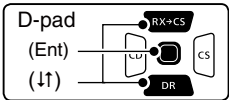

(MENU > GPS > GPS Set > **GPS Select**)

- ③ Refer to the menu sequence show directly above and push D-pad(↑) to select, and then D-pad(Ent) to enter, one or more times until the last screen is displayed.
- ④ Push D-pad(↑) to select “Internal GPS.”
  - The transceiver starts to receive your position data.
- ⑤ Push [MENU]  to save, and exit the MENU screen.

• The GPS icon blinks when receiving data, as illustrated below, and stops blinking when valid data is received.



- If “Manual” was selected, the icon does not appear.
- It may take only a few seconds to receive, but depending on the environment, it may take a few minutes. If you have difficulties receiving, we recommend that you try a different location.

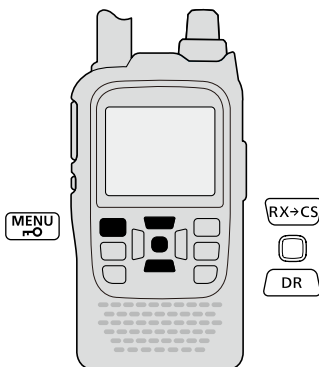

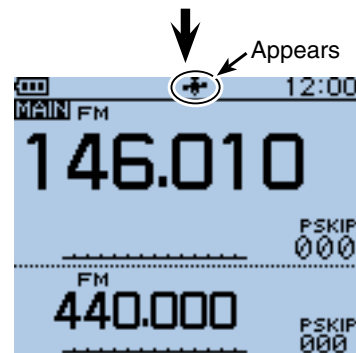
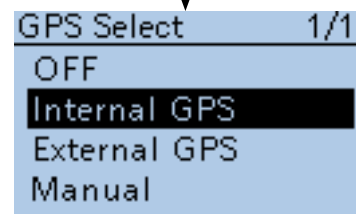
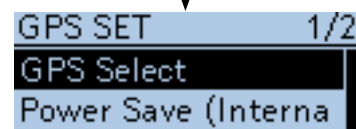
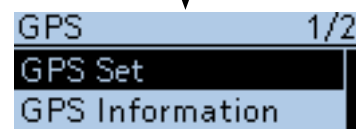
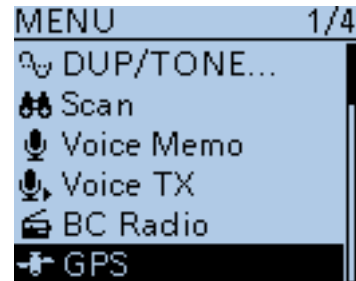

**Example:** Select the “Hirano” repeater that is the top search result.



Continued on the next page.

To display your position data:

- ① Push [QUICK] .
- ② Push D-pad(↑) to select “GPS Position,” and then push D-pad(Ent).
- Your position is displayed on the GPS POSITION screen.
- ③ Push [CLR]  to exit.

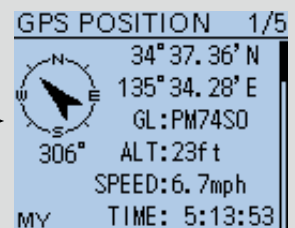
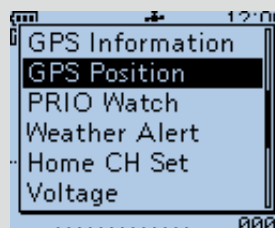

■ “FROM” (Access repeater) setting  
 ◇ Using the Repeater Search function (Continued)

2. Receiving your own position from the GPS receiver

- ① Hold down **DR** for 1 second.  
 • The DR mode is selected.
- ② Push D-pad(↓) to select “FROM,” and then push D-pad(Ent).

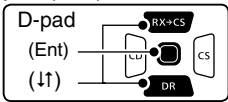

- ③ Push D-pad(↑) to select “Near Repeater,” and then push D-pad(Ent).  
 • The Repeater Search function starts.  
 • Up to 20 of the nearest repeaters are displayed.
- ④ Push D-pad(↑) to select “Hirano,” and then push D-pad(Ent).  
 • “Hirano” is displayed in “FROM.”



**NOTE:** When the position data accuracy level is set to “Approximate,” the direction data is not displayed if the distance to the repeater is under 5 kilometers. (p. 9-30)

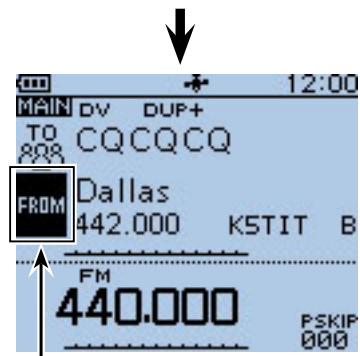

“FROM” is selected.

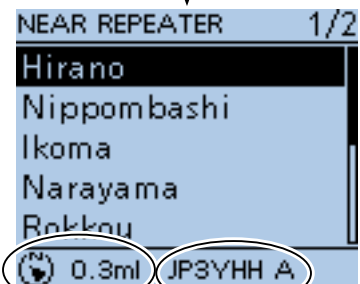
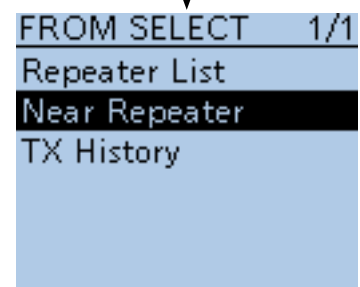

Shows the distance and direction from your position to the repeater

Shows the call sign of “Hirano430,”



Completed

**NOTE:**

When using the Repeater Search function, be sure to first receive your own position data.

- If no repeater is found in a 160 kilometers range, screen 1, as shown to the right, will be displayed.
- If the last received position can be used, screen 2, as shown to the right, will be displayed.

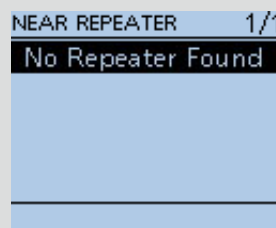

Screen 1

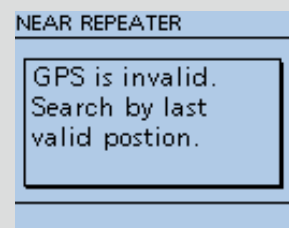

Screen 2

■ “FROM” (Access repeater) setting (Continued)

◇ Using the TX History

The TX History stores up to 10 “FROM” (Access repeater) repeaters used when you transmit a call in the DR mode.

/// **NOTE:** Only repeaters you transmitted to in the DR mode are stored in the TX History.

- ① Hold down **DR** for 1 second.
  - The DR mode is selected.
- ② Push D-pad(↓) to select “FROM,” and then push D-pad(Ent).

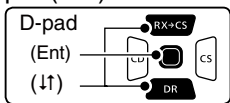

- ③ Push D-pad(↑) to select “TX History,” and then push D-pad(Ent).
- ④ Push D-pad(↑) to select “Hirano,” and then push D-pad(Ent).
  - “Hirano” is displayed on “FROM.”

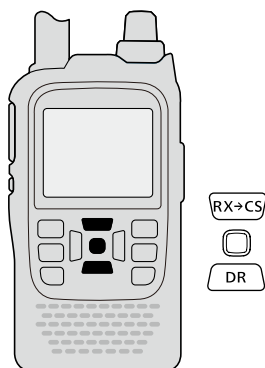

/// You can display detailed repeater information on the TX HISTORY screen, or delete it from there.

➔ Push **[QUICK]** on the TX HISTORY screen, then push D-pad(↑) to select the desired item, and then push D-pad(Ent).

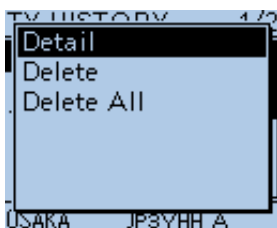

**Example:** Select the “Hirano” repeater from the TX History.

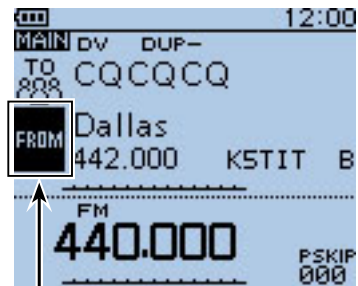

“FROM” is selected.

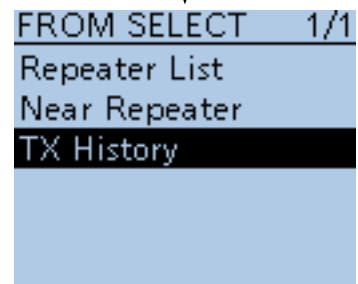

Completed

## ■ “TO” (Destination) setting

The destination **repeater** or station must be set to “TO” when you transmit a call in the DV mode.

You have seven ways to set the destination.

Click the title as shown below to jump to the specified page.

**NOTE:** After you receive the repeater’s signal, the calling station’s call sign can be captured by holding down the Call Sign Capture key (RX→CS), and you can quickly and easily reply to a received call.

“Hamacho” repeater is set in “TO.”

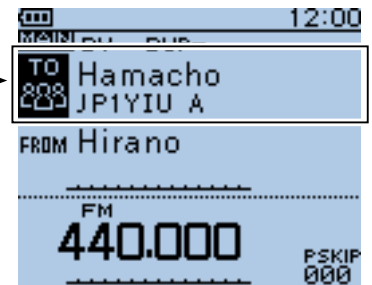

To make a Local Area CQ call

**1: “Local CQ” setting (p. 8-9)**  
Set “CQCQCQ” in “TO” (Destination).

To make a Gateway CQ call

**2: “Gateway CQ” setting (p. 8-10)**  
Select a repeater from the repeater list.

To make a call to a specific station

**3: “Your Call Sign” setting (p. 8-11)**  
Select the station call sign in the Your Call Sign memory.

When the destination data is stored in the RX History

**4: Setting from the RX History (p. 8-12)**  
When you receive a call, the calling station data is stored in the RX History.  
You can select the destination from the record.

When the destination data is stored in the TX History

**5: Setting from the TX History (p. 8-13)**  
When you transmit a call, the destination repeater or station data is stored in the TX History.  
You can select the destination from the record.

To directly input the destination station call sign

**6: Direct Input (UR) (p. 8-14)**  
Directly input the destination station call sign.

To directly input the destination repeater call sign

**7: Direct Input (RPT) (p. 8-15)**  
Directly input the destination repeater call sign.

[TO SELECT] screen

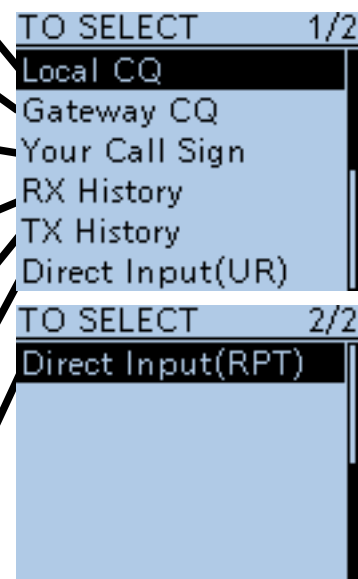

### How to switch the repeater group:

When “Local CQ” or “Gateway CQ” is selected, you can switch the repeater group.

- While in the DR mode, push [QUICK] to open the Quick menu. Then push D-pad(1) to select “Group Select.”
- You can switch the repeater group using D-pad(1)

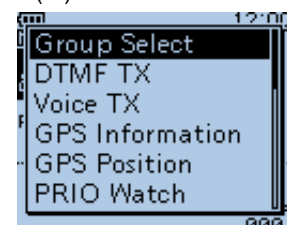

■ “TO” (Destination) setting (Continued)

◇ Using the “Local CQ” (Local Area call)

“CQCQCQ” is set in “TO” to call a station through your local area (access) **repeater.**

- ① Hold down **DR** for 1 second.
  - The DR mode is selected.
- ② Push D-pad(↑) to select “TO” (Destination), and then push D-pad(Ent).

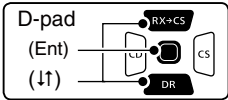

- ③ Push D-pad(↑) to select “Local CQ,” and then push D-pad(Ent).
  - “CQCQCQ” is displayed on “TO.”

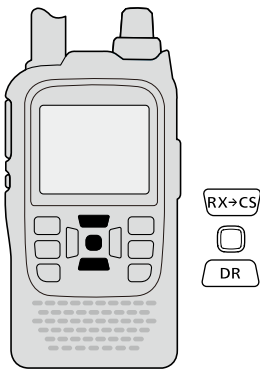

**Example:** Making a Local area call by accessing the “Hirano” repeater.

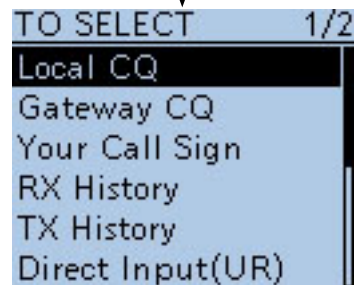
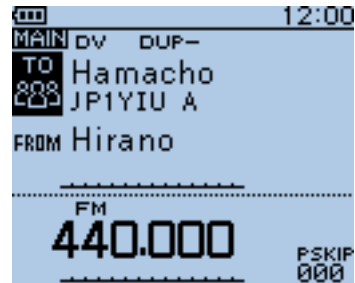

Completed



■ “TO” (Destination) setting (Continued)

◇ Using the “Gateway CQ” (Gateway call)

The destination **repeater** is set in “TO” to call a station through your local area (access) repeater, gateway repeater, the internet and then to your destination repeater.

- ① Hold down **DR** for 1 second.
  - The DR mode is selected.
- ② Push D-pad(↑) to select “TO” (Destination), and then push D-pad(Ent).

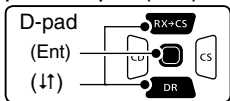

- ③ Push D-pad(↓) to select “Gateway CQ,” and then push D-pad(Ent).
  - The REPEATER GROUP screen is displayed.
- ④ Push D-pad(↓) to select the repeater group where your destination repeater is listed, and then push D-pad(Ent).
  - Example: “11: Japan”
- ⑤ Push D-pad(↓) to select the destination repeater, and then push D-pad(Ent).
  - Example: “Hamacho”
  - “Hamacho” is displayed on “TO.”

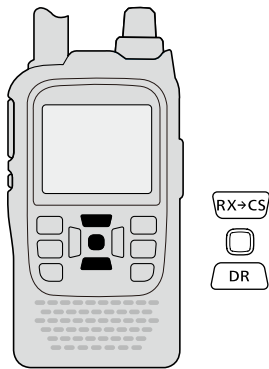

**Example:** Making a gateway CQ call to (Japan; Hamacho) from the “Hirano” repeater.

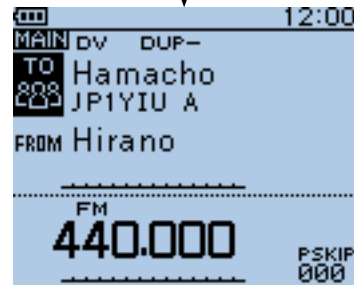
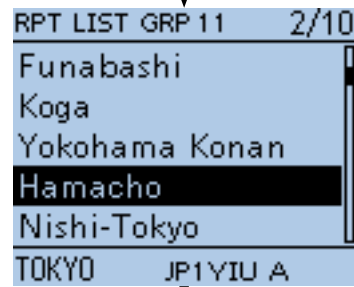
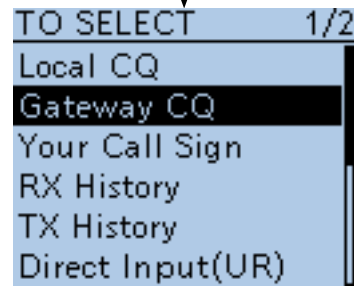
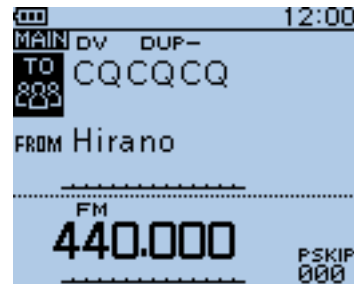

Completed

After selecting a repeater, you can select other repeater preset in your transceiver by rotating [DIAL].

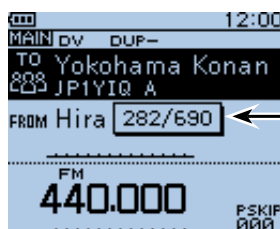

Means this repeater is programmed as the 282th of the 690 repeaters on the repeater list.



■ “TO” (Destination) setting (Continued)

◇ Using the “Your Call Sign”

The “Your Call Sign” memory stores the programmed “UR” (destination) call sign.

When you select an individual station call sign for the “TO” (Destination) setting using “Your Call Sign,” a gateway call can be made.

When you call the destination through a gateway, the signal is automatically sent to the last **repeater** that the station accessed.

So, even if you don't know where the station is, you can make a call.

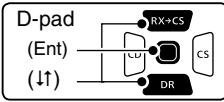
- ① Hold down **DR** for 1 second.
    - The DR mode is selected.
  - ② Push D-pad(↑) to select “TO,” and then push D-pad(Ent).
- 
- ③ Push D-pad(↓) to select “Your Call Sign,” and then push D-pad(Ent).
  - ④ Push D-pad(↓) to select the destination, and then push D-pad(Ent).
    - Example: “TOM”
    - “TOM” is displayed on “TO.”

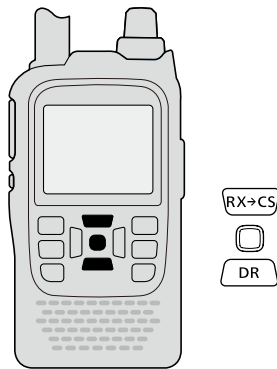

**NOTE:** If the repeater, set to “FROM” (Access Repeater) has no Gateway call sign, you cannot make a gateway call.

After selecting a destination, you can select other station preset in your transceiver by rotating [DIAL].

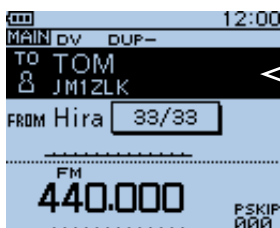

Means this station is programmed as the 33th of the 33 stations on your memory.

**Example:** Select “TOM” from the “Your Call Sign.”

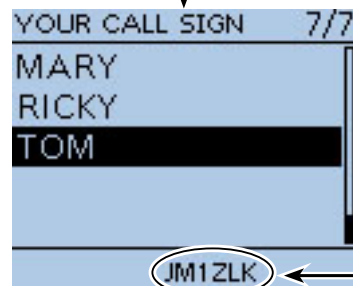
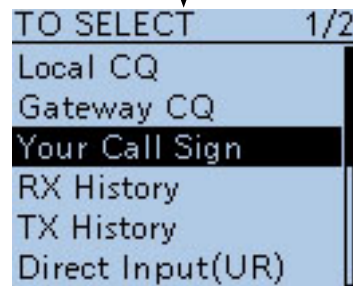

The call sign of the selected station is displayed.



Completed

■ “TO” (Destination) setting (Continued)

◇ Using the RX History

When a call is received in the DV mode, the call data is stored in the RX History.  
Up to 50 Callers, and only the last Called call signs can be stored.

- ① Hold down **DR** for 1 second.
  - The DR mode is selected.
- ② Push D-pad(↑) to select “TO,” and then push D-pad(Ent).
- ③ Push D-pad(↓) to select “RX History,” and then push D-pad(Ent).
- ④ Push D-pad(↓) to select the destination, and then push D-pad(Ent).
  - Example: “TOM”
  - “TOM” is displayed on “TO.”

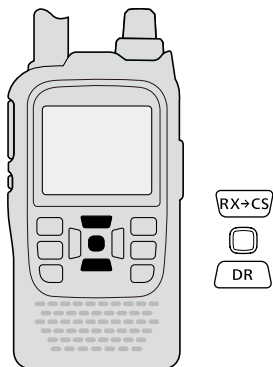
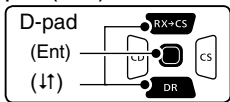

To add the RX HISTORY data to memory, push **[QUICK] [QUICK SPCH]** on the RX HISTORY screen, then push D-pad(Ent).



**Example:** Select “TOM” from RX History.

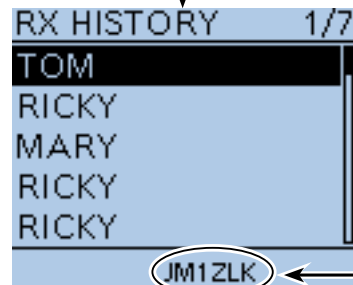
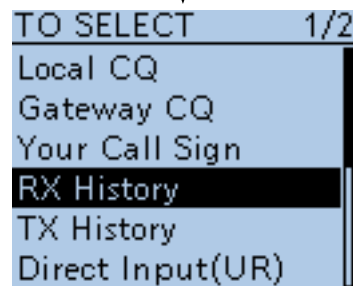

The call sign of the selected station is displayed.



Completed

■ “TO” (Destination) setting (Continued)

◇ Using the TX History

The TX History stores the name and/or call sign of up to 20 “TO” (Destination) settings which were used when you made the calls.

**NOTE:** If you never transmit a call in the DV mode, you cannot select “TO” (destination) from the TX History.

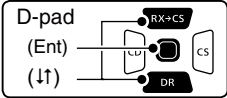
- ① Hold down **DR** for 1 second.
    - The DR mode is selected.
  - ② Push D-pad(↑) to select “TO,” and then push D-pad(Ent).
- 
- ③ Push D-pad(↓) to select “TX History,” and then push D-pad(Ent).
  - ④ Push D-pad(↓) to select the destination, and then push D-pad(Ent).
    - Example: “Dallas”
    - “Dallas” is displayed on “TO.”

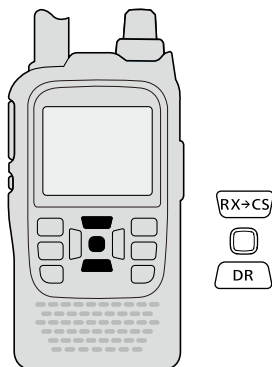

**Example:** Select the “Melbourne” **repeater** in the TX History.

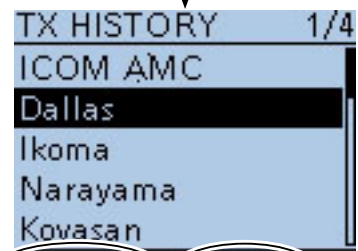
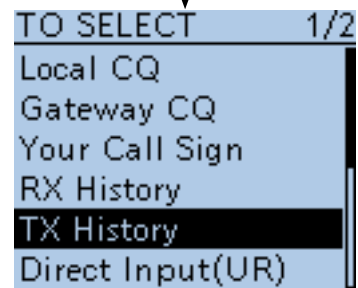

TX      KSTIT B ← “Dallas” repeater’s call sign is displayed.

The Sub name is displayed when a repeater is selected.



Completed

You can add the TX HISTORY data to memory, or delete it from there.

- ➔ Push **[QUICK]** on the TX HISTORY screen, then push D-pad(↓) to select the desired item, and then push D-pad(Ent).

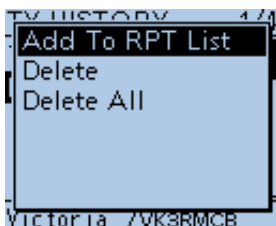

■ “TO” (Destination) setting (Continued)

◇ Directly inputting (UR)

The destination station call sign can be directly input.

- ① Hold down **[DR]** for 1 second.
  - The DR mode is selected.
- ② Push D-pad(↑) to select “TO,” and then push D-pad(Ent).

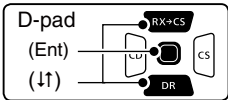

- ③ Push D-pad(↑) to select “Direct Input (UR).”
- ④ Push D-pad(Ent) to enter the edit mode.
- ⑤ Rotate [DIAL] to select a desired character.
  - (Example: J)
  - A to Z, 0 to 9, / and a space can be selected.
  - Rotate [DIAL] counter clockwise to enter a space.
  - Push **[CLR]** V/MHz CLR LOW to delete the selected character, or hold down **[CLR]** V/MHz CLR LOW to continuously erase the characters, first to the right, and then to the left of the cursor.
- ⑥ Push D-pad(→) to move the cursor to the second digit.
- ⑦ Repeat steps ⑤ and ⑥ to enter a call sign of up to 8 characters, including spaces.
  - (Example: First, J, then M, then 1, then Z, then L, then K.)
- ⑧ After entering, push D-pad(Ent) twice to program.
  - “JM1ZLK” is displayed on “TO.”
  - After programming, you can correct the call sign in the DIRECT INPUT (UR) screen.
  - The programmed call sign remains on the DIRECT INPUT (UR) screen, until inputting a new call sign.

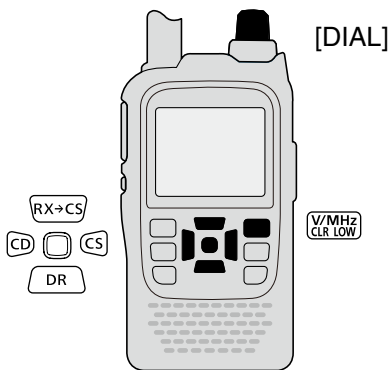

**Example:** Directly input the call sign “JM1ZLK.”

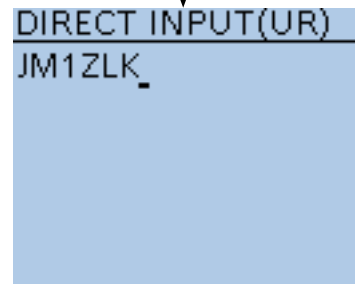
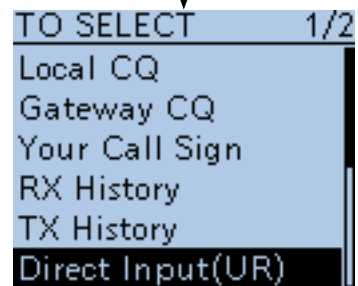

If the programmed call sign is duplicated in “Your Call Sign” memory, the name is displayed. (Only when the name has been programmed.)



■ “TO” (Destination) setting (Continued)

◇ Directly inputting (RPT)

The destination **repeater** call sign can be directly input.

- ① Hold down **[DR]** for 1 second.
  - The DR mode is selected.
- ② Push D-pad(↑) to select “TO,” and then push D-pad(Ent).

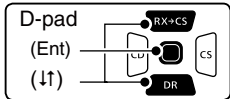

- ③ Push D-pad(↓) to select “Direct Input (RPT).”
- ④ Push D-pad(Ent) to enter the edit mode.
- ⑤ Rotate [DIAL] to select a desired character.
  - (Example: J)
  - A to Z, 0 to 9, / and a space can be selected.
  - Rotate [DIAL] counter clockwise to enter a space.
  - Push **[CLR]** V/MHz CLR LOW to delete the selected character, or hold down **[CLR]** V/MHz CLR LOW to continuously erase the characters, first to the right, and then to the left of the cursor.
- ⑥ Push D-pad(→) to move the cursor to the second digit.
- ⑦ Repeat steps ⑤ and ⑥ to enter a name of up to 8 characters, including spaces.
  - (Example: First, J, then P, then 3, then Y, then D, then H.)
- ⑧ After entering, push D-pad(Ent) twice.
  - “JP3YDH” is displayed on “TO.”
  - After programming, you can correct the call sign in the DIRECT INPUT (RPT) screen.
  - The programmed call sign remains on the DIRECT INPUT (RPT) screen, until inputting a new call sign.

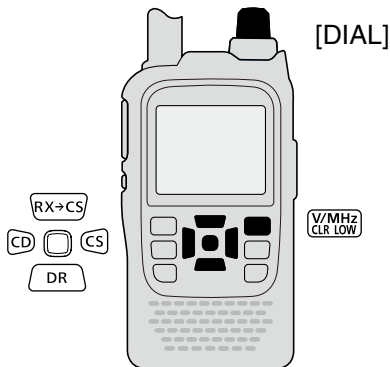

**Example:** Directly input the call sign “JP3YDH”

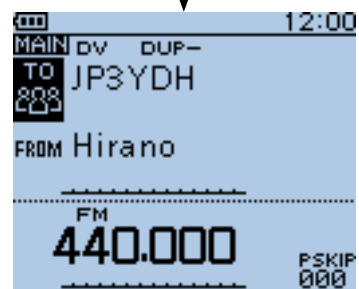
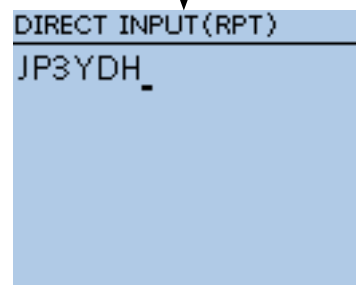
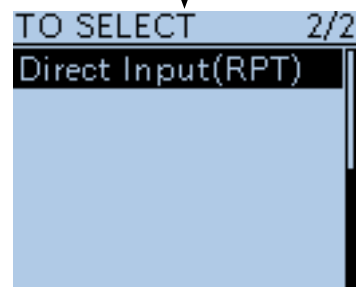
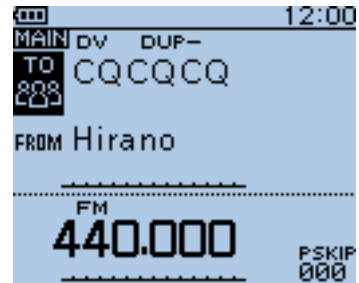

Completed

If the programmed call sign is duplicated to the repeater list, the name is displayed. (Only when the name has been programmed.)



The following settings are also correct.

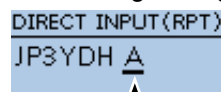

The repeater node\* is input.

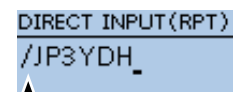

“/” is input. In this case, the call sign is of a repeater for a Gateway call.

\*Although the repeater node letter is ‘B’ for 430 MHz band, ‘A’ is used in Japan. See page 8-1 for details.

■ Message operation.....	9-2
◇ TX message programming.....	9-2
◇ Message Transmission.....	9-3
◇ TX message deleting.....	9-4
■ Received call sign viewing.....	9-5
◇ View in the RX History screen.....	9-5
■ BK mode communication.....	9-7
■ EMR communication.....	9-8
◇ Adjusting the EMR AF level.....	9-9
■ Display type setting.....	9-9
■ DV automatic detection.....	9-10
■ Automatic Reply function.....	9-11
◇ Recording an Auto Reply voice announcement.....	9-12
◇ Playing back the recorded voice audio.....	9-12
◇ Auto Position Reply function.....	9-13
■ Low-speed data communication.....	9-14
◇ Connection.....	9-14
◇ Low-speed data communication application setting.....	9-14
◇ Low-speed data communication operation.....	9-14
■ Speech function.....	9-15
◇ To announce the received call sign.....	9-15
◇ To announce the RX>CS call sign.....	9-16
◇ Speech Language selection.....	9-17
◇ Phonetic Code setting for the Speech alphabet character.....	9-17
◇ Speech speed selection.....	9-18
◇ Speech level selection.....	9-18
■ Digital squelch functions.....	9-19
◇ The digital call sign squelch setting.....	9-19
◇ Pocket beep function with the digital call sign squelch.....	9-19
◇ The digital code squelch setting.....	9-20
◇ Pocket beep function with the digital code squelch.....	9-20
■ Viewing the call signs.....	9-21
■ Repeater list.....	9-22
◇ Repeater list contents.....	9-22
■ Repeater list programming.....	9-23
◇ New repeater programming.....	9-23
◇ Required items for the communication cases.....	9-23
■ Editing a repeater list.....	9-32
■ Deleting a repeater list.....	9-33
■ Rearrange the display order of the repeater.....	9-34
■ Adding the Repeater information using the RX History.....	9-35
■ Skip setting for the DR mode scan.....	9-36
◇ Individual skip setting.....	9-36
◇ Group skip setting.....	9-37
■ Repeater group name programming.....	9-38
■ Repeater detail screen.....	9-39
■ Your (destination) call sign programming.....	9-40
■ Deleting Your (destination) call sign.....	9-42
■ Rearrange the display order of Your (destination) call sign.....	9-43
■ About the repeater list default values.....	9-44
◇ Opening the default repeater list.....	9-44
■ Your setting is correct?.....	9-45

**IMPORTANT!**

• The **repeater** list, described in this manual, may differ from your transceiver's preloaded contents.

• Although Japanese repeaters are used in the setting examples, the Japanese repeater node (port) letters are different from other country's.

Be sure to add a repeater node letter as the 8th digit in the call sign field after a repeater call sign, according to the repeater frequency band, as shown below.

1200 MHz : A (B in Japan)

430 MHz : B (A in Japan)

144 MHz : C (no D-STAR repeaters in Japan)

## Message operation

The transceiver has a total of 5 message memories to store short messages to transmit during DV mode operation.



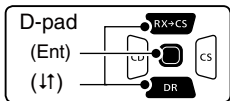

TX messages of up to 20 characters can be programmed in each of the 5 message memories.

### TX message programming

- ① Push [MENU] .
- ② Push D-pad(↑) to select the root item ("My Station"), and then push D-pad(Ent).



- ③ Push D-pad(↓) to select "TX Message," and then push D-pad(Ent).
- ④ Push D-pad(↑) to select message memory number "1."
- ⑤ Push [QUICK] .
- ⑥ Push D-pad(↑) to select "Edit."
- ⑦ Push D-pad(Ent) to enter the TX message edit mode.

- ⑧ Rotate [DIAL] to select a desired character.  
(Example: J)
  - Selectable input characters are Upper case letters, Lower case letters, Numbers or Symbols.
  - The selected character blinks.
  - Push D-pad(←) to move the cursor backward or forward.
  - While selecting a character, push [QUICK]  to change the character to an upper case or lower case letter.
  - While selecting a digit, push [QUICK]  to open the input mode selection window.
  - A space can be selected, in any input mode selected.
  - Rotate [DIAL] counter clockwise to enter a space.
  - Push [CLR]  to delete the selected character, or hold down [CLR]  to continuously delete the characters, first to the right, and then to the left of the cursor.
  - See page 2-7 for programming details.

- ⑨ Push D-pad(→) to move the cursor to the second digit.
- ⑩ Repeat steps ⑧ and ⑨ to enter up to 20 characters, including spaces.  
(Example: First, J, then A, then P, then A, then N, then (space), then >, then T, then O, then M.)

- ⑪ After entering the message, push D-pad(Ent) two times to program.
- ⑫ Push [MENU]  to exit the MENU screen.

**Example:** To program "JAPAN >TOM" into message memory number 1.

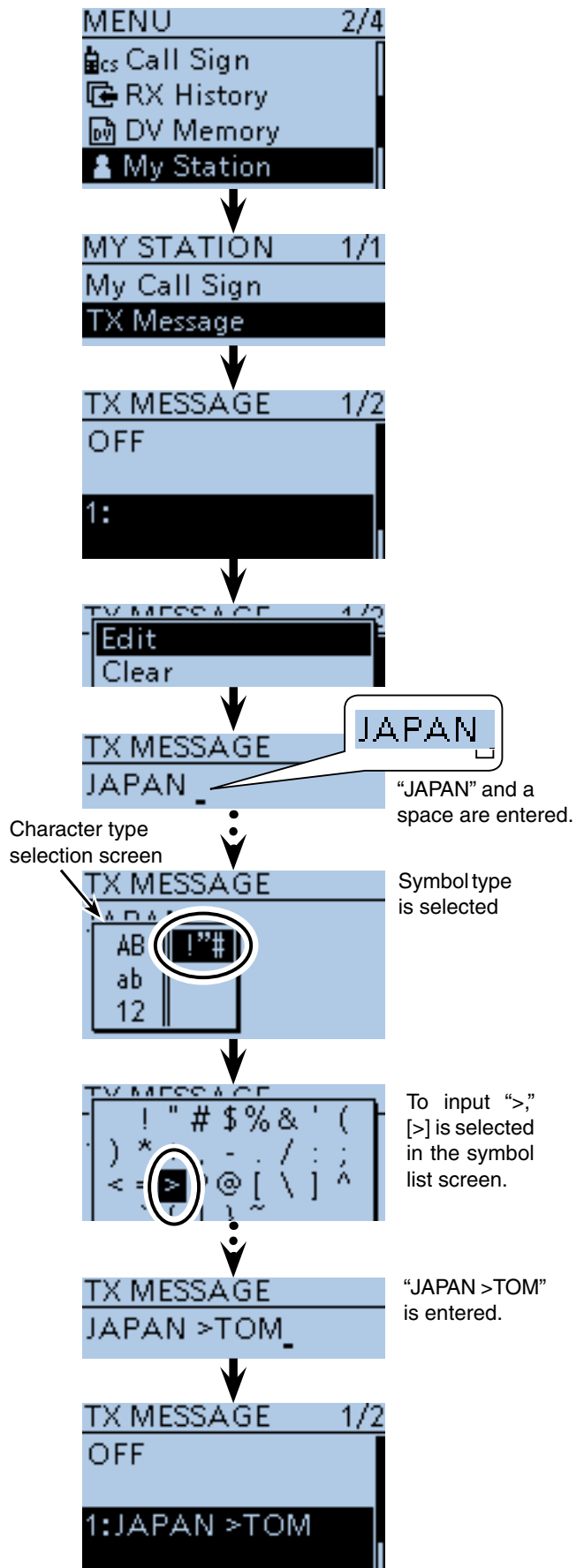





■ Message operation (Continued)

◇ Message Transmission

You can transmit a preprogrammed text message by pushing [PTT]. First, select a TX message which also turns ON the message transmission function.

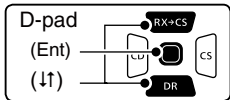
- ① Push [MENU] .
- ② Push D-pad(↑) to select the root item (“My Station”), and then push D-pad(Ent).



- ③ Push D-pad(↓) to select “TX Message,” and then push D-pad(Ent).
- ④ Push D-pad(↑) to select message memory number 1 to 5.
  - To turn OFF the message transmission function, select “OFF.”
- ⑤ After selecting, push D-pad(Ent).
- ⑥ Push [MENU]  to exit the MENU screen.
  - The message is transmitted along with your voice signal.
  - The message is transmitted each time you push [PTT].
  - The message is automatically transmitted every 30 seconds during continuous transmission.

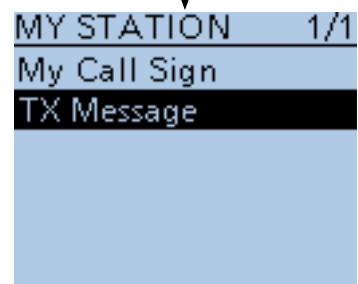
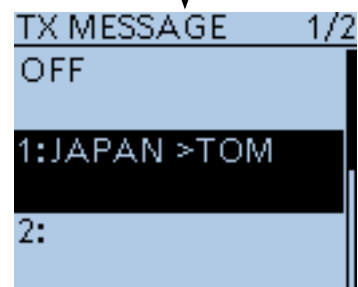
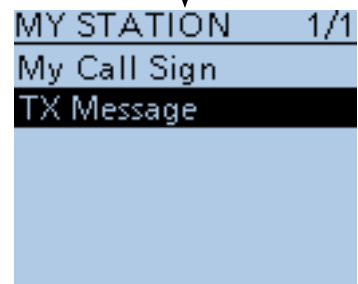
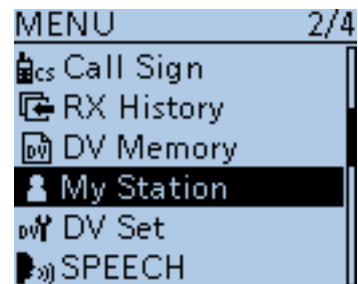

**RX message display function**

As the default, the received message is automatically displayed and scrolled on the LCD.

To not display and scroll the received message, turn OFF the RX message display function in “RX Message” of the MENU screen. (p. 16-74)

(MENU > Display > RX Message)



← The received message is displayed and scrolled here.





■ Message operation (Continued)

◇ TX message deleting

The programmed TX message can be deleted, as described below.

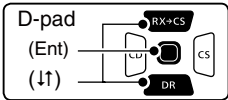
- ① Push [MENU] .
- ② Push D-pad(↓) to select the root item (“My Station”), and then push D-pad(Ent).



- ③ Push D-pad(↓) to select “TX Message,” and then push D-pad(Ent).
- ④ Push D-pad(↓) to select message memory number 1.
- ⑤ Push [QUICK] .
- ⑥ Push D-pad(↓) to select “Clear,” and then push D-pad(Ent).
- ⑦ Push D-pad(↑) to select “YES,” and then push D-pad(Ent).
- ⑧ Push [MENU]  to exit the MENU screen.

**Example:** To delete the programmed TX message “JAPAN >TOM” from message memory number 1.

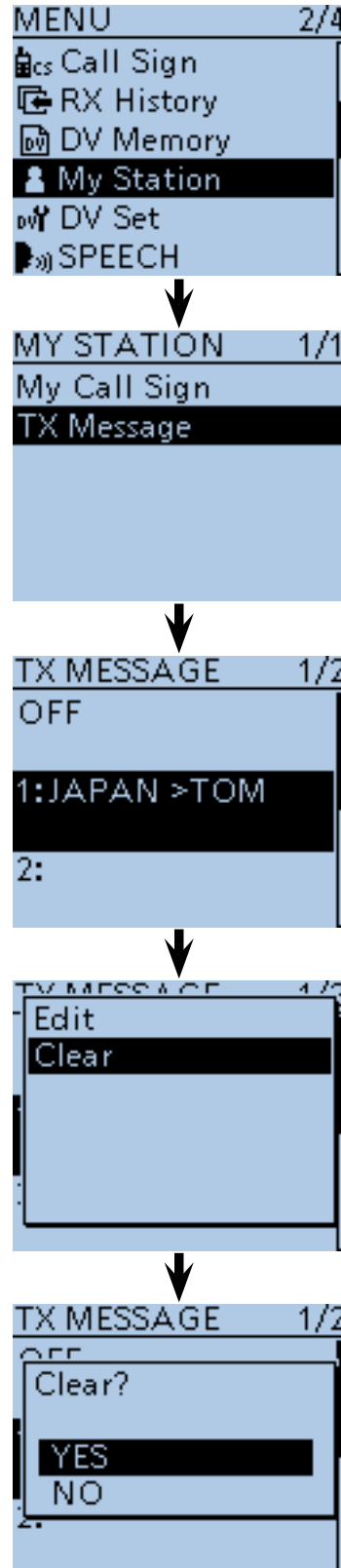

## ■ Received call sign viewing

When a DV call is received, the calling station and the **repeater's** call signs are stored in the RX HISTORY screen.

Up to 50 calls can be stored.

Even if the transceiver is turned OFF, the RX record won't be deleted.

The stored call signs can be displayed in the following manner.

### ◇ View in the RX History screen

- ① Push [MENU] .
- ② Push D-pad(↑) to select the root item ("RX History"), and then push D-pad(Ent).

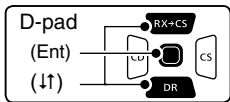

- ③ Push D-pad(↑) to select an RX history number between "RX01" and "RX50."

- In addition to the RX history number, the call signs of the caller and called station, RX message, Repeater call sign of the called station, received date and time are displayed on the LCD.
- If only one call is received, skip step ③.
- "GW" appears when the gateway call is received.
- "GPS" appears when the received call includes GPS position.
- "UP" appears when the repeater uplink signal is received.

- ④ Push D-pad(Ent) to show the contents of the RX history.

- ⑤ Push D-pad(↑) to switch the displayed contents of the RX history.

- CALLER : Shows the call sign of the caller station and any note programmed after the call sign.
- CALLED : Shows the call sign of the called station.
- RXRPT1\* : Shows the call sign of the repeater that was accessed by the caller station. If it was a call through a gateway and the internet, this item displays the gateway repeater call sign of your local area repeater.
- Rx RPT2\* : Shows the call sign of the repeater you received the call from.
- MESSAGE : Shows any message included in the received call, if programmed.
- RX TIME : Shows the date and time the call was received.

\*"FREQUENCY" appears instead of these items when the call was not through a repeater (Simplex call), to show the frequency that was used.

- ⑥ Push [MENU]  to exit the MENU screen.

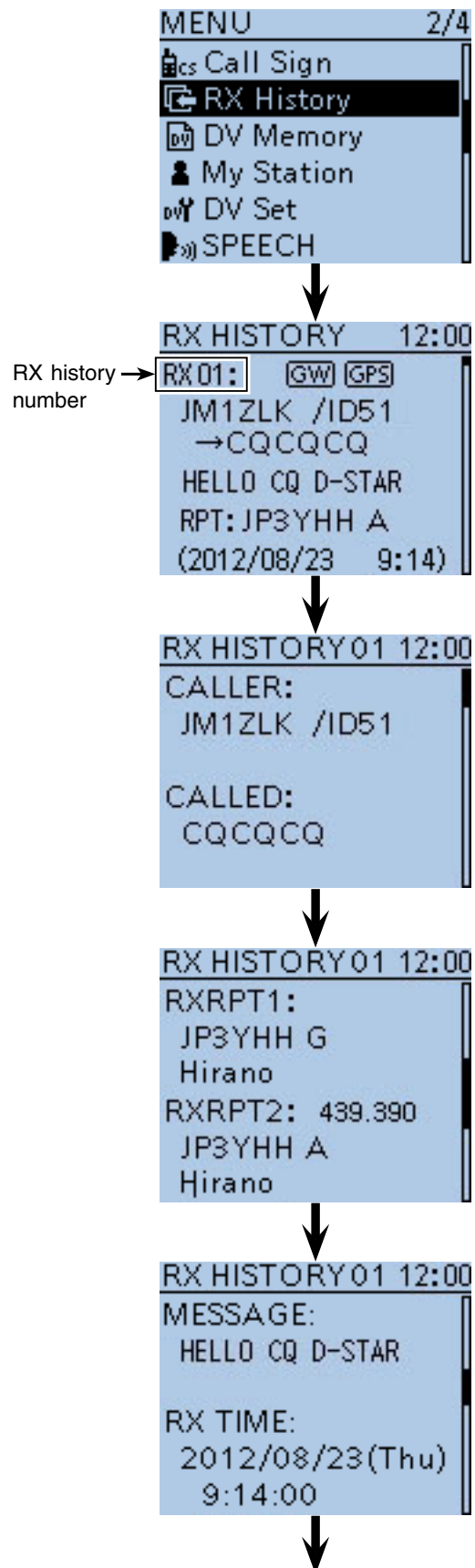

When the received call includes the GPS position data, it is displayed after RX TIME.

■ Received call sign viewing (Continued)

You can delete the RX HISTORY data.  
 ➔ Push [QUICK]<sup>[QUICK]</sup><sub>[SPCH]</sub> on the RX HISTORY or the contents screen, then push D-pad(↑) to select "Delete" or "Delete All." And then push D-pad(Ent) to delete.



↓  
 When the received call includes GPS position data.

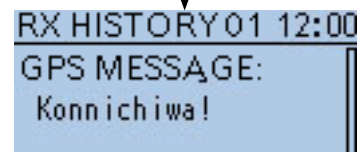
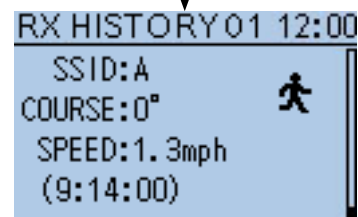
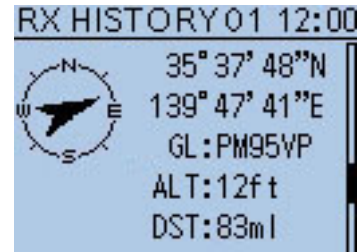

✓ **Information**

"RX RPT1" setting may be differ, depending on the communication form.

Example: When a Local area call is received.

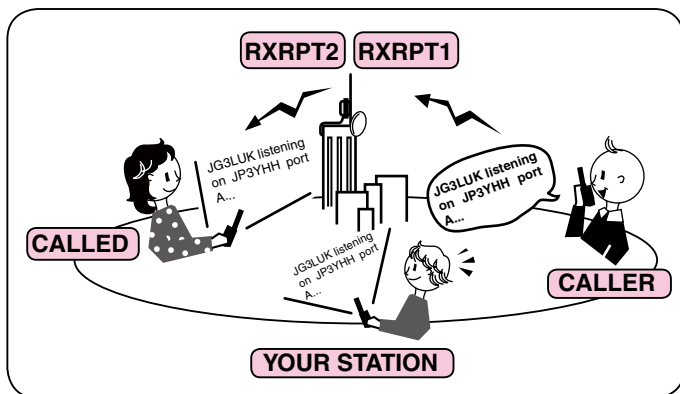

Example: When a Gateway call is received.

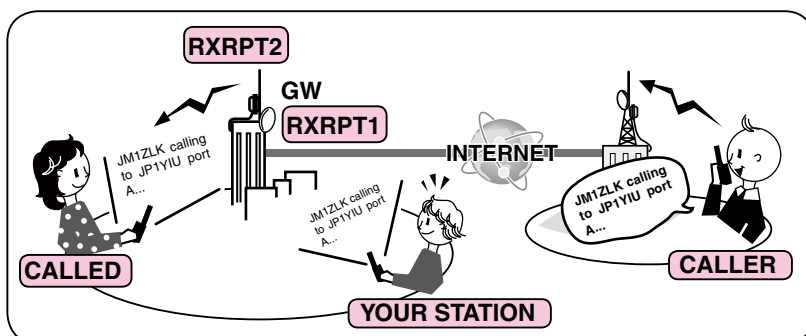

## ■ BK mode communication

The BK (Break-in) function allows you to break into a conversation, where the two other stations are communicating with call sign squelch enabled. (Default: OFF)

**NOTE:** The BK function is automatically turned OFF when transceiver is turned OFF.

- ① After receiving a DV conversation, hold down **[RX>CS]** for 1 second.
  - After releasing **[RX>CS]**, beeps sound, and the calling station call sign is announced. (RX>CS Speech function)
  - The calling station or call sign of the **repeater** used is automatically set.
  - When a call sign is not received correctly, error beeps sound, and no call sign is set.

- ② Push **[MENU]**.
- ③ Push D-pad(↑) to select the root item (“DV Set”), and then push D-pad(Ent).

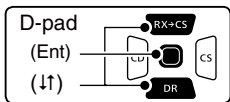

- ④ Push D-pad(↓) to select “BK,” and then push D-pad(Ent).
- ⑤ Push D-pad(↑) to select “ON.”
- ⑥ Push **[MENU]** to exit the MENU screen.
  - “BK” appears.
- ⑦ When both stations are in standby, push **[PTT]** to transmit.
  - The TX/RX indicator lights red.
  - “BK” blinks on the station that receives the break-in call.
- ⑧ Release **[PTT]** to receive.
  - Wait for a reply call from the station.
- ⑨ After receiving the reply call, communicate normally.
- ⑩ To cancel the BK mode, select “OFF” in “BK,” as step ⑤, or turn OFF the power.

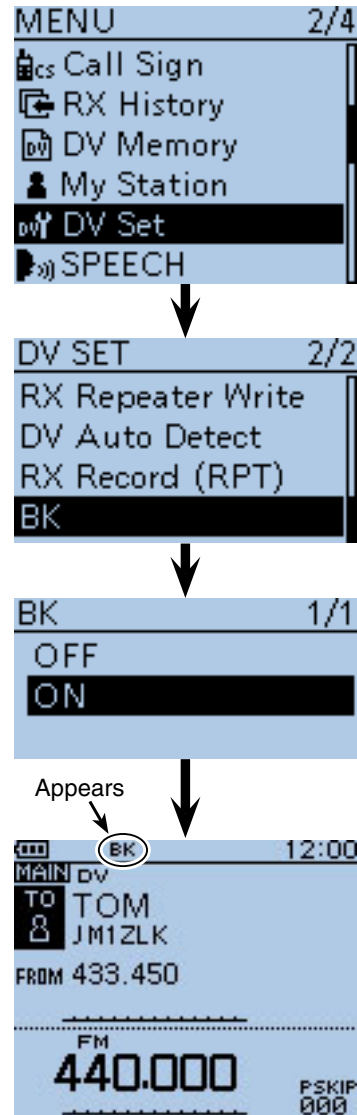

### How to use Break-in?

While using digital call sign squelch, the squelch never opens (no audio is heard) even if a call is received, unless your own call sign is specified.

However, when a call including the “BK ON” signal (break-in call) is received, the squelch will open and audio is heard even if the call is specified for another station.

#### • Station C calling to Station A with “BK OFF”

Station A and B are communicating using digital call sign squelch.

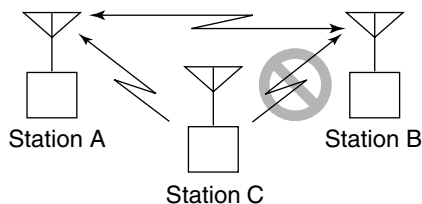

Station B never hears that Station C is calling Station A.

#### • Station C calling to Station A with “BK ON”

Station A and B are communicating using the digital call sign squelch.

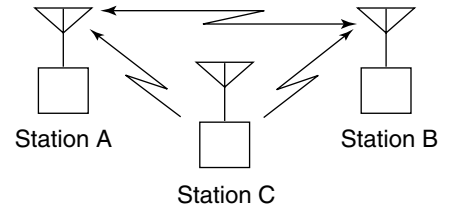

Station B also hears that Station C is calling Station A.

## EMR communication

The EMR (Enhanced Monitor Request) communication mode can be used in only the DV mode. In the EMR mode, no call sign setting is necessary.

All transceivers that receive an EMR mode signal automatically open their squelch to receive the signal.

When an EMR mode signal is received, the audio (voice) will be heard at the specified level, even if the volume setting level is set to the minimum level, or digital call sign/digital code squelch is in use. (Default: OFF)

**NOTE:** The EMR communication function is automatically turned OFF when the transceiver is turned OFF.

- ① Hold down **[DR]** for 1 second.
  - The DR mode is selected.
- ② Push D-pad(↓) to select “FROM,” and then push D-pad(Ent).

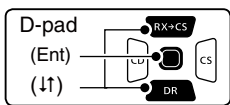

- ③ Push D-pad(↑) to select “Repeater List,” and then push D-pad(Ent).
- ④ Push D-pad(↑) to select “11: Japan,” and then push D-pad(Ent).
- ⑤ Push D-pad(↑) to select “Hamacho,” and then push D-pad(Ent).
  - “Hamacho” is displayed on “FROM”.
- ⑥ Push **[MENU]**.
- ⑦ Push D-pad(↑) to select the root item (“DV Set”), and then push D-pad(Ent).
- ⑧ Push D-pad(↑) to select “EMR,” and then push D-pad(Ent).
- ⑨ Push D-pad(↓) to select “ON.”
- ⑩ Push **[MENU]** to exit the MENU screen.
  - “EMR” appears.
- ⑪ Push **[PTT]** to transmit.
  - The TX/RX indicator lights red.
  - “EMR” blinks on a station that receives the EMR signal. And the audio (voice) will be heard at the specified level, or the [VOL] control level, whichever is higher.
- ⑫ Release **[PTT]** to receive.
- ⑬ To cancel the EMR mode, select “OFF” in step ⑨, as described above, or turn OFF the power.

**Example:** To transmit from the “Hamacho” repeater in the EMR mode

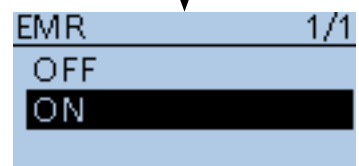
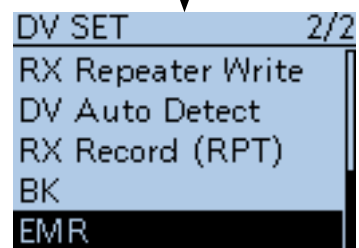
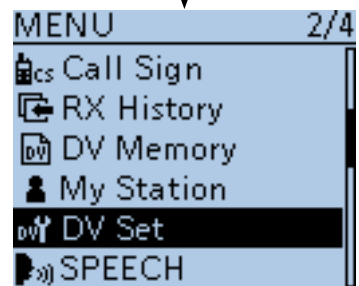
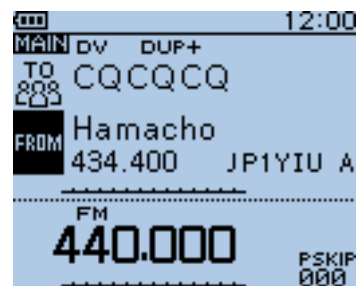

Appears

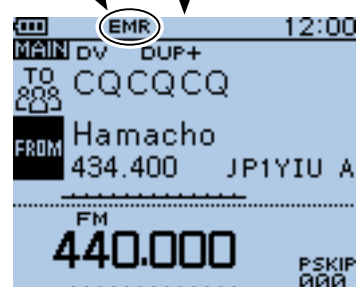

■ EMR communication (Continued)

◇ **Adjusting the EMR AF level**

The audio output level when an EMR signal is received is adjustable between 0 and 39.

When an EMR signal is received, the audio will be heard at the preset level, or the [VOL] control level, whichever is higher.

To disable the setting, set it to “0.”

- ① Push [MENU] .
- ② Push D-pad(↑) to select the root item (“DV Set”), and then push D-pad(Ent).

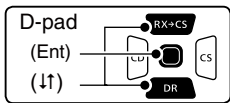

- ③ Push D-pad(↓) to select “EMR AF Level,” and then push D-pad(Ent).
- ④ Push D-pad(↑) to adjust the EMR audio output level between 0 (minimum) and 39 (maximum) in single digit steps. (Default: 19)
- ⑤ Push [MENU]  to exit the MENU screen.

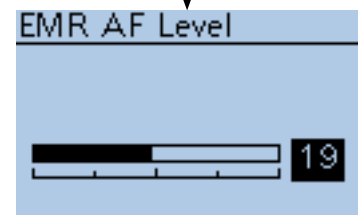
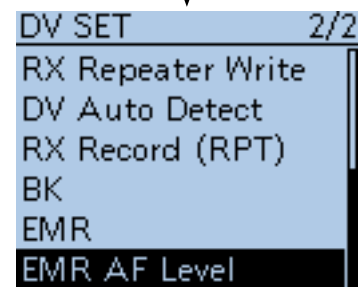

■ **Display type setting**

The display size in the DR mode, such as a **repeater** name, call sign, and so on, can be set to Large.

(Default: Normal)

- ① Push [QUICK] .
- ② Push D-pad(↑) to select “Display Type,” and then push D-pad(Ent).
- ③ Push D-pad(↓) to select “Large,” and then push D-pad(Ent).
  - The display size changes to large such as the repeater name set in “TO” and “FROM.”

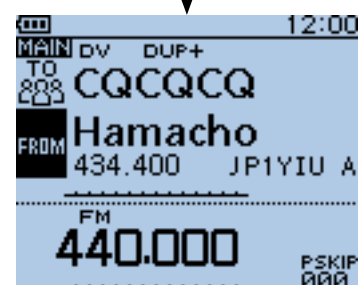
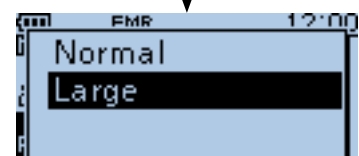
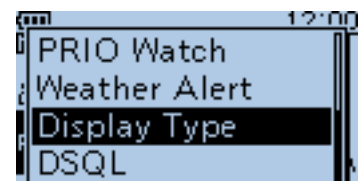

## ■ DV automatic detection

If you receive an FM signal during DV mode operation, the “DV” and “FM” icons alternately blink to indicate the received signal is FM.

When the DV Auto Detect function is turned ON, the transceiver automatically selects the FM mode to temporarily monitor the signal. (Default: OFF)

- Regardless of this setting, the “DV” and “FM” icons alternately blink if you receive an FM signal during DV mode operation.

- ① Push [MENU] .
- ② Push D-pad(↑) to select the root item (“DV Set”), and then push D-pad(Ent).

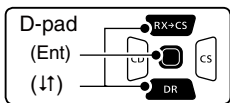

- ③ Push D-pad(↑) to select “DV Auto Detect,” and then push D-pad(Ent).
- ④ Push D-pad(↓) to select “ON.”
- ⑤ Push [MENU]  to exit the MENU screen.
  - When an FM signal is received in the DV mode, the “DV” and “FM” icons sequentially blink, and the transceiver receives the signal in the FM mode.

When digital call sign squelch (DSQL) or digital code squelch (CSQL) is selected, the transceiver does not receive FM signals, even if this function is ON. You can silently wait for calls from others.

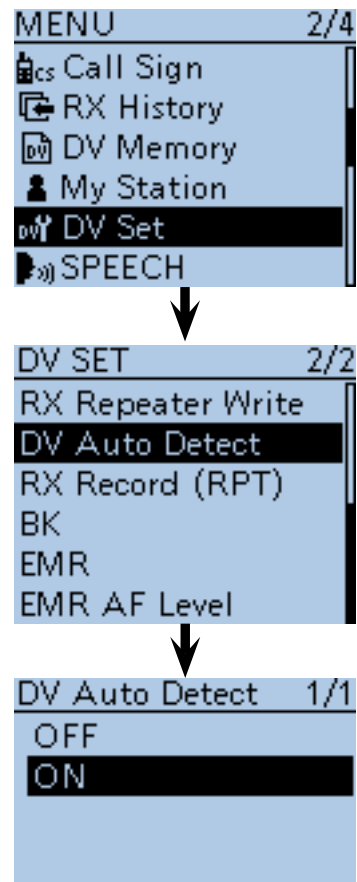

### <When an FM signal is received while in the DV mode>

• DV Auto Detect function: OFF  
 The “DV” and “FM” icons sequentially blink, but the audio cannot be heard.

• DV Auto Detect function: ON  
 The “DV” and “FM” icons sequentially blink, and the audio can be heard.

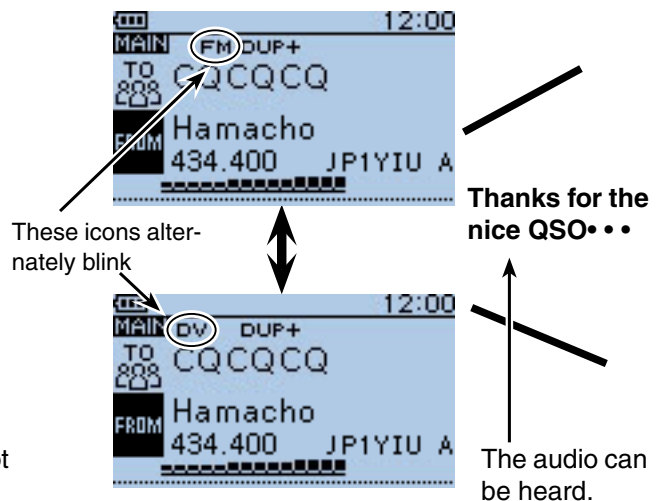
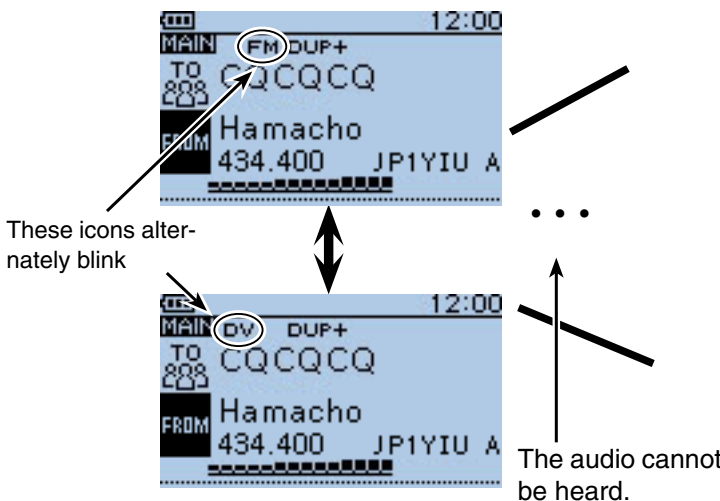





## ■ Automatic Reply function

When a call addressed to your own call sign is received, the Automatic Reply function automatically replies with your call sign. (Default: OFF)

Depending on the setting, the recorded message or your position may be transmitted with the call sign.

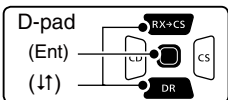
- ① Push [MENU] .
- ② Push D-pad(↑) to select the root item (“DV Set”), and then push D-pad(Ent).



- ③ Push D-pad(↑) to select “Auto Reply,” and then push D-pad(Ent).
- ④ Push D-pad(↑) to select “ON,” “Voice” or “Position.”
  - ON : Replies with your own call sign. (No audio reply is sent)
  - Voice : Replies with your call sign and any Auto Reply message recorded on the microSD (up to 10 seconds).  
If no microSD card is inserted or no message is recorded, only your call sign is transmitted. The transmitted audio can be monitored.
  - Position : Replies with your own call sign and transmits your position using the internal GPS receiver. (p. 9-13)  
When “OFF” or “Manual” is set in “GPS Select,” the internal GPS receiver is temporarily turned ON.  
When “External GPS” is set in “GPS Select,” the transceiver transmits your position. But if the external GPS receiver is not connected, the internal GPS receiver will be activated.
- ⑤ Push [MENU]  to exit the MENU screen.

### NOTE:

- When “ON” or “Voice” is selected, the Automatic Reply function is automatically turned OFF, when you push [PTT].
- When “Position” is selected, the Automatic Reply function is kept to ON, even if you push [PTT].
- The Power Save function is disabled when “ON” or “Voice” is selected.
- The Power Save function is enabled when “Position” is selected.
- The Automatic Reply function cannot be used on the SUB band.

### To record the voice signal

You can record a voice announcement for the Auto Reply function in “DV Auto Reply” on the MENU screen. (p. 16-27)

(MENU > Voice Memo > DV Auto Reply)

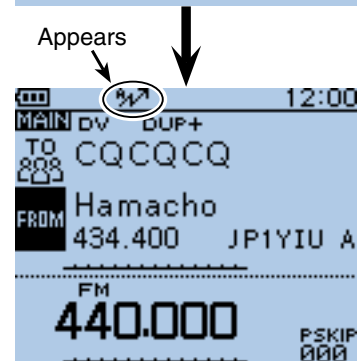
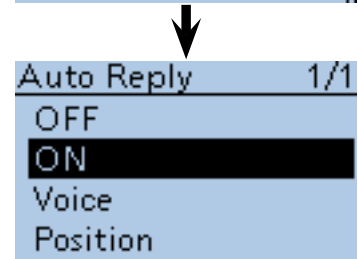
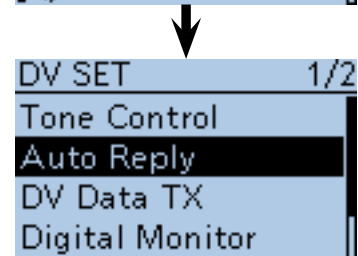

After receiving a call from “JG3LUK,” the transceiver automatically sends a reply call.



“TO” setting does not change, but “UR: JG3LUK (Caller’s call sign)” is displayed.



■ Automatic Reply function (Continued)

◇ Recording an Auto Reply voice announcement

The Auto Reply voice announcement can be recorded and saved on the microSD card to reply to the call with your voice.

**NOTE:** Be sure to insert a microSD card to the [micro SD] slot of the transceiver before starting to record a voice signal.

- ① Push [MENU] .
- ② Push D-pad(↑) to select the root item (“Voice Memo”), and then push D-pad(Ent).

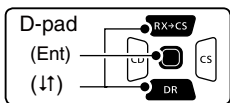

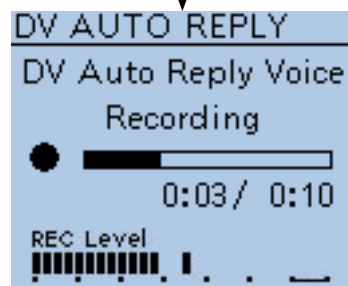
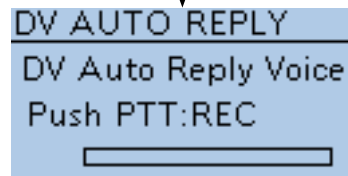
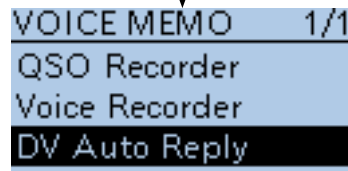
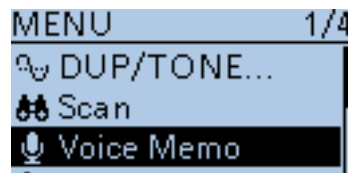

- ③ Push D-pad(↑) to select “DV Auto Reply,” and then push D-pad(Ent).
- ④ Push [PTT] to start recording. (No RF is transmitted)
  - After releasing [PTT], the recording is cancelled.
  - Maximum record period is 10 second
  - Hold the microphone 5 to 10 cm (2 to 4 inches) from your mouth, then speak into the microphone at a normal voice level.
  - Only one announcement can be recorded. The current contents will be overwritten if you record again.
- ⑤ Push [MENU]  to exit the MENU screen.



← While recording  
 ← Audio level is displayed

◇ Playing back the recorded voice audio

The recorded voice audio for the Auto Reply function can be played back.

- ① Push [MENU] .
- ② Push D-pad(↑) to select the root item (“Voice Memo”), and then push D-pad(Ent).
- ③ Push D-pad(↑) to select “DV Auto Reply,” and then push D-pad(Ent).
- ④ Push D-pad(Ent) to start the playback.
- ⑤ Push [MENU]  to exit the MENU screen.

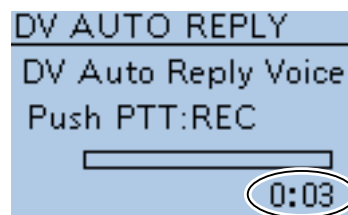

← Recording time is displayed

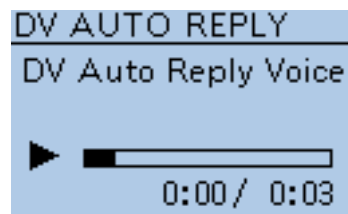

While playing back

✓ Information

You can delete the recorded audio.

- ➔ On the DV AUTO REPLY screen, push [QUICK] , and then push D-pad(Ent).

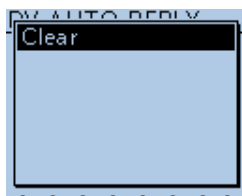

**When no microSD card is inserted:**

When no microSD card is inserted, this error message is displayed.

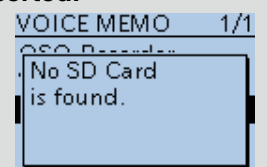

■ Automatic Reply function (Continued)

◇ Auto Position Reply function

When you receive a call addressed to your own call sign, but are in a situation that makes it difficult to operate the transceiver, this function automatically replies with your own call sign and transmits your position.

After receiving the Auto Position Reply call, the destination screen shows your position. The D-STAR product other than the ID-51 do not show the position after receiving a call.

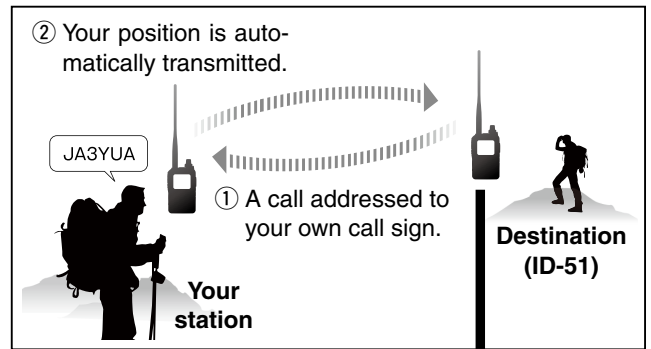

③ After receiving, the screen shows the position.

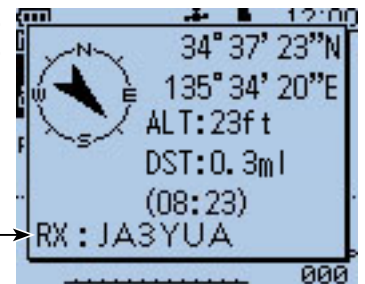

Scrolls your call sign or the TX message.  
• Your status message may be displayed.

After receiving the Auto Position Reply call, the destination screen shows your position.

• When no valid position is received

After receiving a call addressed to your own call sign, even if "OFF" or "Manual" is set in "GPS Select," the internal GPS receiver is temporarily turned ON for approximately 5 seconds to receive your position. Then, the transceiver automatically replies with a message, as described below.

When the internal GPS receiver is temporarily turned ON, and valid data is received, the transceiver automatically replies if a call addressed to your own call sign is received again.

• Reply message list when no valid position is received

Message	Status
No Position	When no position is received
Old Position	2 minutes or more has passed since receiving the position.
No Posi & GPS Start	The internal GPS receiver is temporarily turned ON, but has not received the position yet.
Old Posi & GPS Start	The internal GPS receiver is temporarily turned ON, and 2 minutes or more has passed since receiving the position.



Scrolls your message

After receiving the Auto Position Reply call, the destination screen shows your message.

NOTE:

- When "External GPS" is set in "GPS Select," and if the external GPS receiver is not connected, the internal GPS receiver will be activated.
- The position transmission is based on the GPS transmission mode. (p. 16-40)
- When the settings of GPS transmission mode are incorrect for the Automatic Reply function, the transceiver automatically correct them to reply a call.
- When the GPS transmission mode is OFF, "GPS-A" is automatically selected.

## ■ Low-speed data communication

In addition to digital voice communication, low-speed data communication can be made.

Use the optional OPC-2218LU DATA COMMUNICATION CABLE with a third-party serial data communication software.

### ◇ Connection

Connect the transceiver to your PC using the OPC-2218LU cable, as illustrated below.

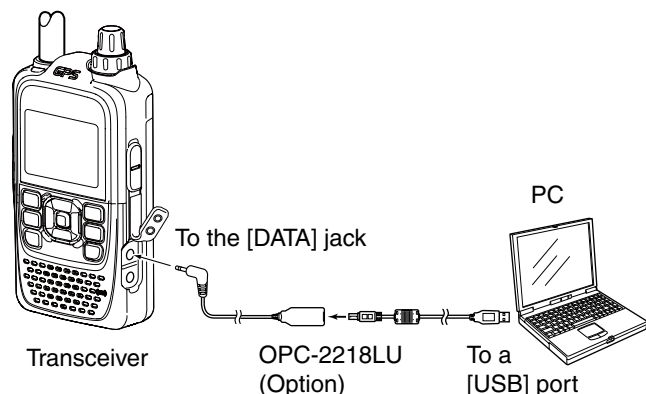

#### Before starting low-speed data communication:

The "DV Data TX" item is set to "Auto" by default. So, depending on the data communication application software, the transceiver may automatically transmit the data only when you input text on the software screen.

**NOTE:** Before starting, be sure to set the following items;

- Set the "GPS SELECT" option to "OFF," "Internal GPS" or "Manual" in the MENU screen. (p. 16-32)  
(MENU > GPS > GPS Set > **GPS Select**)
- Set the "GPS OUT" option to "OFF" in the MENU screen. (p. 16-33)  
(MENU > GPS > GPS Set > **GPS Out**)
- Set the "GPS TX Mode" option to "OFF" in the MENU screen. (p. 16-40)  
(MENU > GPS > **GPS TX Mode**)

### ◇ Low-speed data communication application setting

Configure the serial data communication software as follows.

- Port : The COM port number which is used by the ID-51A/E.\*1
- Baud rate : 4800/9600 bps\*2
- Data : 8 bit
- Parity : None
- Stop : 1 bit
- Flow control : Xon/Xoff

\*1 Depending on the PC environment, the COM port number used by the ID-51A/E may be higher than 5. In such case, use the application which can set to higher than 5.

\*2 The baud rate can be set in the "Data Speed" item of the MENU screen. (p. 16-69)  
(MENU > Function > **Data Speed**)

### ◇ Low-speed data communication operation

- ① Set your own call sign, UR call sign and the **repeater** call sign.
- ② Follow the instructions of the data communication application software.
- ③ When data is input from a PC through the [DATA] jack, the transceiver automatically transmits it.
  - The TX/RX indicator lights red.
  - Push [PTT] to transmit the data and a voice signal when "PTT" is selected in the "DV Data TX" item of the MENU screen. (p. 16-56)  
(MENU > DV Set > **DV Data TX**)
  - Before transmission, the transceiver sends approximately 500 milliseconds carrier sense.

#### NOTE:

- Only **ASCII** code can be used for the low-speed data communication.
- A message of up to 20 characters can be transmitted with a DV voice signal.
- Depending on the combination of your PC and your serial data communication software, some data may be lost.
- While receiving voice communication or low-speed data communication through the internet, some packets may be lost due to network error (poor data throughput performance). In such a case, "L" appears on the LCD to show the Packet Loss has occurred.

## ■ Speech function

The speech function announces the called station call sign, or the individual or station call sign that is selected from the RX History by holding down [RX+CS] and rotating [DIAL].

It is convenient when you cannot watch the LCD, or you missed the call's audio.

This function helps you to know the call sign of the caller station without seeing the LCD.

### ◆ To announce the received call sign

The received call sign can be announced.

- ① Push [MENU] .
- ② Push D-pad(↑) to select the root item ("SPEECH"), and then push D-pad(Ent).

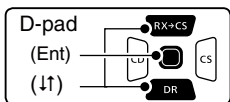

- ③ Push D-pad(↑) to select "RX Call Sign SPEECH," and then push D-pad(Ent).
- ④ Push D-pad(↑) to select "ON (Kerchunk)" or "ON (All)."

  - ON (Kerchunk): When a DV call is received, and if the call time is short, the calling station's call sign is announced. (Default)
  - ON (All) : When a DV call is received, the calling station's call sign is announced.

- ⑤ Push [MENU]  to save, and exit the MENU screen.

  - When a DV call is received, the standby beep sounds, and after approximately 1 second, the call sign is announced.

#### NOTE:

- Even if a "/" and a note are after a call sign, they are not announced.
- The announced contents cannot be recorded on the microSD card.

- The ID-51A/E has other Speech functions:

#### [DIAL] speech function

The frequency or **repeater** call sign is announced 1 second after [DIAL] selection.

(MENU > SPEECH > **DIAL SPEECH**)

#### Mode speech function

The selected operating mode is announced when [MODE]  is pushed.

(MENU > SPEECH > **MODE SPEECH**)

- When the digital squelch function is used, and if a received signal is not addressed to your call sign, or does not include an unmatched digital code, the calling station's call sign is not announced.

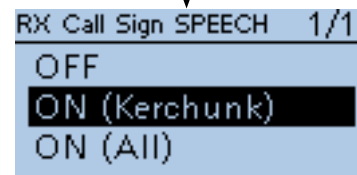
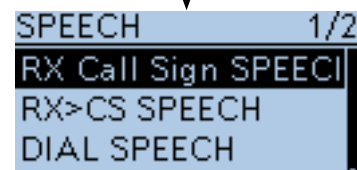

#### • When "ON (Kerchunk)" is selected

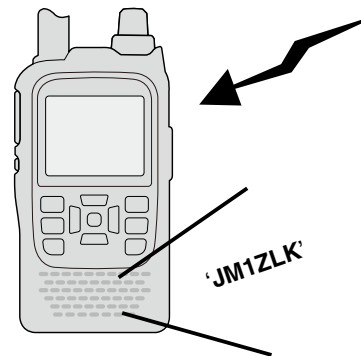

#### • When "ON (All)" is selected



■ Speech function (Continued)

◇ To announce the RX>CS call sign

The station call sign that is selected from the RX History by holding down **[RX>CS]** and rotating **[DIAL]**, will be announced.

- ① Push **[MENU]** **[MENU]**.
- ② Push D-pad(↑) to select the root item (“SPEECH”), and then push D-pad(Ent).

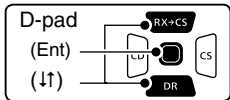

- ③ Push D-pad(↑) to select the root item (“RX>CS SPEECH”), and then push D-pad(Ent).
- ④ Push D-pad(↓) to select “ON.” (Default: ON)
- ⑤ Push **[MENU]** **[MENU]** to exit the MENU screen.
- ⑥ While holding down **[RX>CS]**, rotating **[DIAL]** to select the station call sign.
  - After releasing **[RX>CS]**, the selected station call sign is announced.

**NOTE:**  
 While the call sign is being announced, you cannot hear any received audio, and the audio is not recorded on the microSD card.  
 If the call sign is announced while recording, the recorded contents are silent during the announcement.

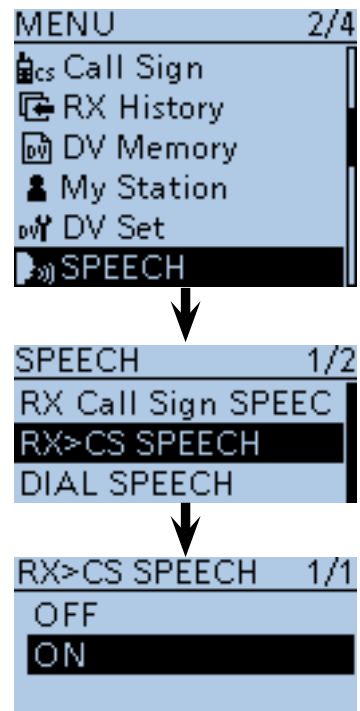
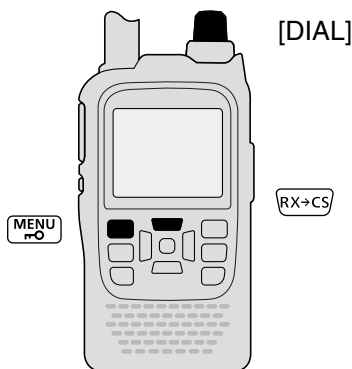

• When “ON” is selected

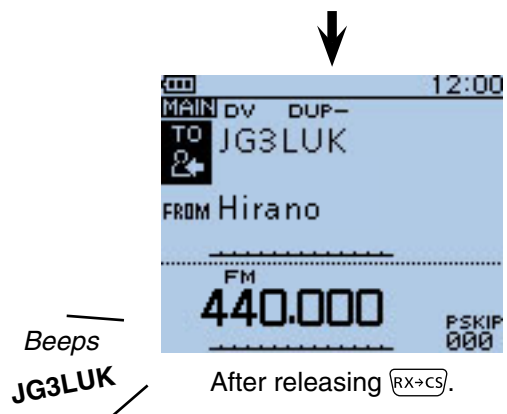
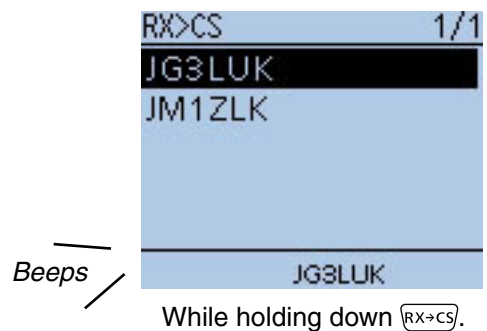

■ Speech function (Continued)

◇ **Speech Language selection**

The speech language can be set to English or Japanese.

This setting is used for all Speech functions.

- ① Push [MENU] .
- ② Push D-pad(↑) to select the root item (“SPEECH”), and then push D-pad(Ent).

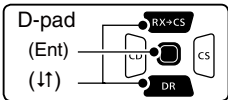

- ③ Push D-pad(↑) to select the root item (“SPEECH Language”), and then push D-pad(Ent).
- ④ Push D-pad(↑) to select “English” or “Japanese.” (Default: English)
- ⑤ Push [MENU]  to exit the MENU screen.
  - A call sign is announced in the selected language.

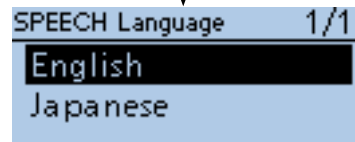



◇ **Phonetic Code setting for the Speech alphabet character**

The speech alphabet character can be set to phonetic code.

This setting is used for all Speech functions.

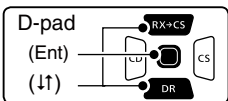
- ① Push [MENU] .
- ② Push D-pad(↑) to select the root item (“SPEECH”), and then push D-pad(Ent).



- ③ Push D-pad(↑) to select “Alphabet,” and then push D-pad(Ent).
- ④ Push D-pad(↓) to select “Phonetic Code.”
- ⑤ Push [MENU]  to save, and exit the MENU screen.

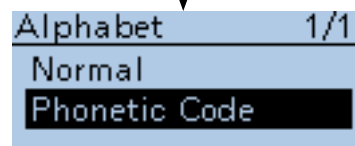
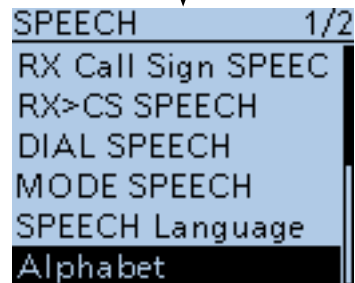

• **When “Phonetic Code” is selected**



JULIET MIKE ONE  
 ZULU LIMA KILO

Example: JM1ZLK

■ Speech function (Continued)

◇ **Speech speed selection**

The speech speed can be set to slow or fast. This setting is used for all Speech functions.

- ① Push [MENU] .
- ② Push D-pad(↑) to select the root item (“SPEECH”), and then push D-pad(Ent).

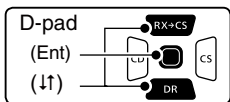

- ③ Push D-pad(↑) to select “SPEECH Speed,” and then push D-pad(Ent).
- ④ Push D-pad(↑) to select “Slow” or “Fast.” (Default: Fast)
- ⑤ Push [MENU]  to exit the MENU screen.

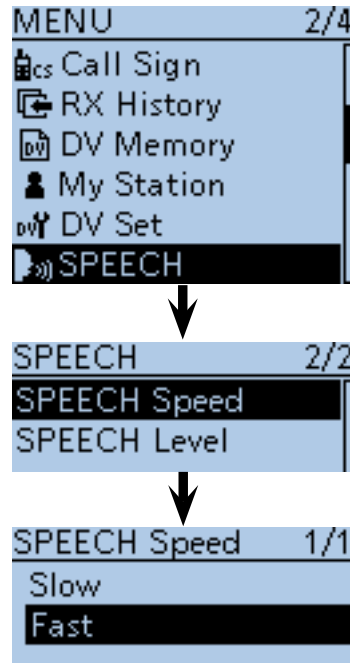

◇ **Speech level selection**

The speech volume level can be set to between 0 (minimum) and 9 (maximum). This setting is used for all Speech functions.

- ① Push [MENU] .
- ② Push D-pad(↑) to select the root item (“SPEECH”), and then push D-pad(Ent).

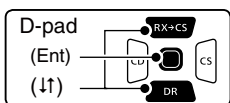

- ③ Push D-pad(↑) to select “SPEECH Level,” and then push D-pad(Ent).
- ④ Push D-pad(↑) to set the speech volume level to between 0 (minimum) and 9 (maximum). (Default: 7)
- ⑤ Push [MENU]  to exit the MENU screen.
  - When “0” (minimum) is selected, the call sign won’t be announced.
  - The volume level can be adjusted with the [VOL] control.

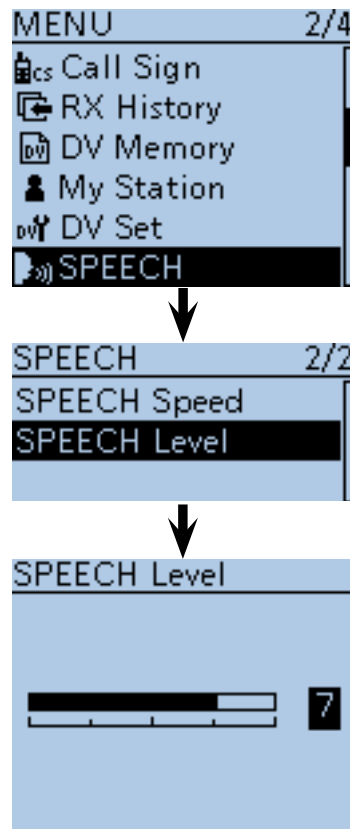



## ■ Digital squelch functions

The digital squelch opens only when receiving a signal addressed to your own call sign, or a signal that includes a matching digital code.

You can silently wait for calls from others.

### ◇ The digital call sign squelch setting

- ① Hold down **[DR]** for 1 second.
  - The DR mode is selected.
  - To use the digital call sign squelch function in another mode, push **[V/MHz]** or **[M/CALL]** to select the VFO, Memory, or CALL channel mode.
- ② Push **[QUICK]**.
- ③ Push D-pad(↑) to select “DSQL,” and then push D-pad(Ent).

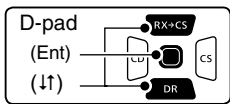

- ④ Push D-pad(↑) to select “DSQL ((·))” or “DSQL.”
  - DSQL ((·)) : Turn ON the digital call sign squelch pocket beep.
  - DSQL : Turn ON the digital call sign squelch.
- ⑤ Push D-pad(Ent) to set the digital call sign squelch, and then exit the Quick menu screen.
  - “DSQL ((·))” or “DSQL” appears.
- ⑥ When the received signal includes a matching call sign, the squelch opens and the audio is heard.
  - When the received signal’s call sign does not match, digital call sign squelch does not open; however, the S/R/F meter shows the received signal level.

#### NOTE:

- **DO NOT** use the digital code squelch function when communicating with two or more stations, because the digital call sign squelch function opens only when receiving a signal addressed to your own call sign. Thus the digital call sign squelch function can be used when communicating with only one station.
- While operating in the low-speed data communication mode, the digital squelch opens even if receiving a signal is not addressed to your own call sign.

### ◇ Pocket beep function with the digital call sign squelch

When a received signal is addressed to your own call sign, the transceiver emits beep tones for 30 seconds and “((·))” blinks.

- ➔ Push **[PTT]** to answer, or push D-pad(Ent) to stop the beeps or “((·))” blinking.
  - “((·))” disappears.

If no operation is performed for 30 seconds, the beep tones automatically stops, but “((·))” continues to blink to inform you of a call.

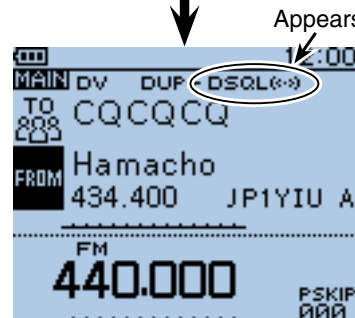
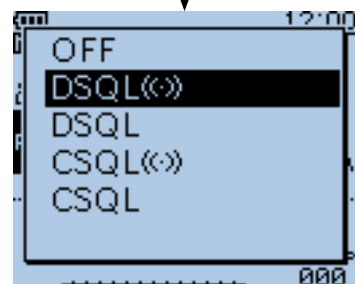
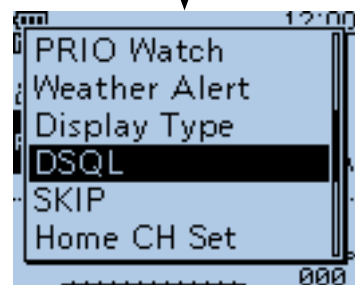
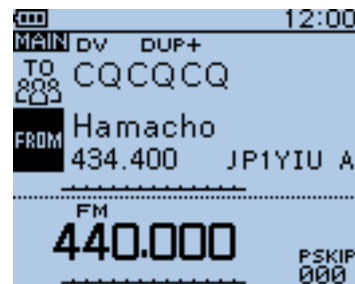

#### • When “DSQL ((·))” is selected

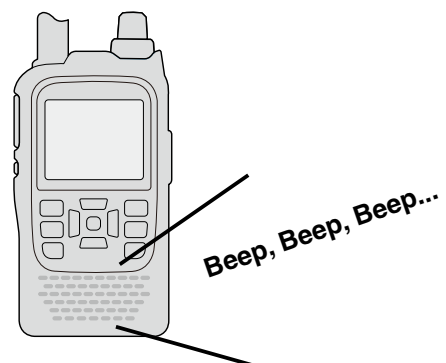



■ Digital squelch functions (Continued)

◇ The digital code squelch setting

- ① Hold down [DR] for 1 second.
  - The DR mode is selected.
  - To use the digital call sign squelch function in another mode, push [V/MHz] or [M/CALL] to select the VFO, Memory, or CALL channel mode.
- ② Push [QUICK].
- ③ Push D-pad(↑) to select “DSQL,” and then push D-pad(Ent).

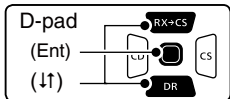

- ④ Push D-pad(↑) to select “CSQL ((·))” or “CSQL.”
  - CSQL ((·)): Turn ON the digital code squelch pocket beep.
  - CSQL : Turn ON the digital code squelch.
- ⑤ Push D-pad(Ent) to set the digital code squelch, and then exit the quick menu screen.
  - “CSQL ((·))” or “CSQL” appears.
- ⑥ Push [MENU].
- ⑦ Push D-pad(↑) to select the root item (“DUP/TONE...”), and then push D-pad(Ent).
- ⑧ Push D-pad(↓) to select “Digital Code,” and then push D-pad(Ent).
- ⑨ Rotate [DIAL] to select a digital code between 00 and 99 for the digital code squelch function.
- ⑩ Push [MENU] to save, and exit the MENU screen.
- ⑪ When the received signal includes a matching code, the squelch opens and the audio is heard.
  - When the received signal’s code does not match, the digital code squelch does not open; however, the S/R meter shows the received signal strength.

**NOTE:** While operating in the low-speed data communication mode, the digital code squelch opens even if receiving a signal does not match to your digital code.

◇ Pocket beep function with the digital code squelch

When a received signal matches your digital code, the transceiver sounds beep tones for 30 seconds and “((·))” blinks.

- ➔ Push [PTT] to answer, or push D-pad(Ent) to stop the beeps or “((·))” blinking.
  - “((·))” disappears.

If no operation is performed for 30 seconds, the beep tones automatically stop, but “((·))” continues to blink to inform you of a call.

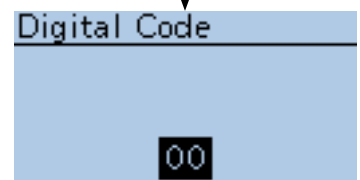
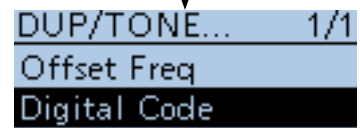
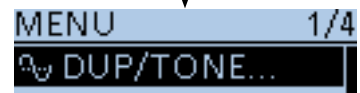
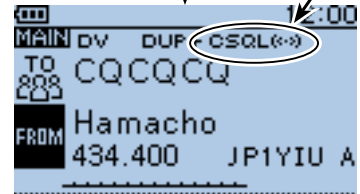
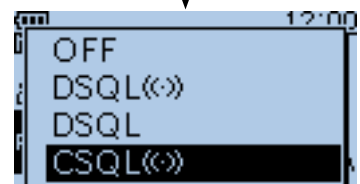
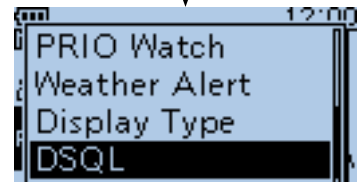
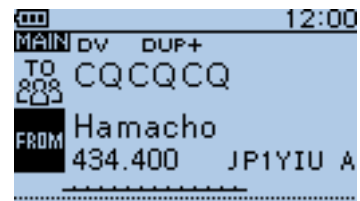

• When “CSQL ((·))” is selected

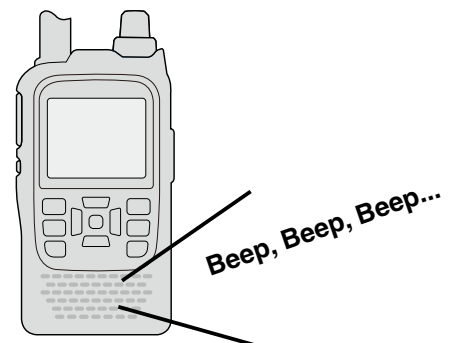

## ■ Viewing the call signs

- ① Push [MODE]<sup>[MODE SCAN]</sup> one or more times to select the DV mode.
- ② Hold down [CS] for 1 second to display the CALL SIGN screen.
  - The CALL SIGN screen can be displayed in the DR, VFO, Memory or Call channel mode.
  - To select the name display mode, push [QUICK]<sup>[QUICK SPCH]</sup>, and then push D-pad(↑) to select “Name Display.” After selecting, push D-pad(Ent).
- ③ Push [CLR]<sup>[V/MHz CLR LOW]</sup> to return to the previous screen.

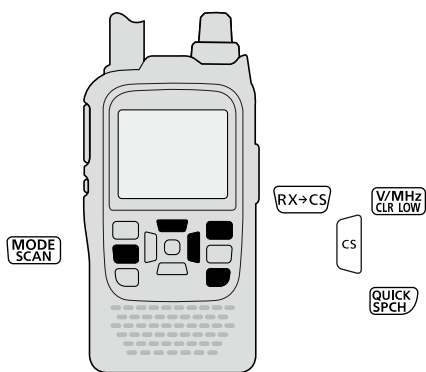

While operating D-STAR in the Memory mode.

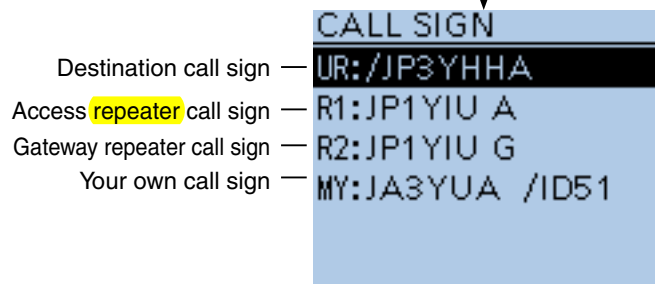
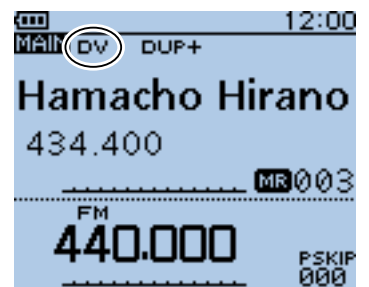

- Destination call sign —
- Access **repeater** call sign —
- Gateway repeater call sign —
- Your own call sign —

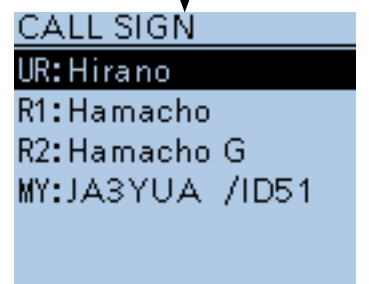
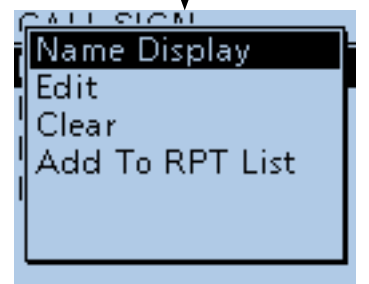

## ■ Repeater list

You can store **repeater** information for quick and simple communication in up to 750 repeater memory channels (Repeater list) in up to 25 Groups. Programming the repeater list is required for DR mode operation.

### ◇ Repeater list contents

The following contents are included in the repeater list:

- NAME (Repeater name) (p. 9-24)
- SUB NAME (Repeater sub name) (p. 9-25)
- CALL SIGN (Repeater call sign and port letter) (p. 9-26)
- GW CALL SIGN (Gateway repeater's call sign and port "G") (p. 9-27)
- GROUP (Repeater group) (p. 9-27)
- USE(FROM) (Access repeater use) (p. 9-28)
- FREQUENCY (Access repeater's input frequency)\* (p. 9-28)
- DUP (**Duplex** direction)\* (p. 9-29)
- OFFSET FREQ (**Frequency offset**)\* (p. 9-29)
- POSITION (Position data accuracy level) (p. 9-30)
- LATITUDE (Latitude position of the repeater) (p. 9-30)
- LONGITUDE (Longitude position of the repeater) (p. 9-30)
- **UTC** OFFSET (UTC Offset) (p. 9-31)

\* Appears only when USE(FROM) is selected as YES.

**NOTE:** For easy operation, the repeater list is pre-loaded into your transceiver. However, if the CPU clears all programmed contents (All Reset), the repeater list is also cleared. We recommend that memory data be backed up externally or be saved to a PC using the supplied CS-51 CLONING SOFTWARE.

#### About the repeater list:

The repeater list can be downloaded from the Icom website.

<http://www.icom.co.jp/world/support/download/firm/index.html>

**Example:** "Hirano" repeater information

REPEATER LIST 1/5
NAME: Hirano
SUB NAME: OSAKA
CALL SIGN: JP3YHH A
REPEATER LIST 2/5
GW CALL SIGN: JP3YHH G
GROUP: 11 Japan
USE(FROM): YES
REPEATER LIST 3/5
FREQUENCY: 439.390.00
DUP: DUP-
OFFSET FREQ: 5.000.00
REPEATER LIST 4/5
POSITION: Exact
LATITUDE: 34°37.55'N
LONGITUDE: 135°34.09'E
REPEATER LIST 5/5
UTC OFFSET: + 9:00

## ■ Repeater list programming

This section describes how to manually program new **repeater** into the repeater list.

The required setting items differ, depending on the repeater use. Be sure to confirm the required items, as shown to the right.

**NOTE:** To program a repeater into the repeater list, the repeater's call sign **MUST** be entered.

### ◇ Required items for the communication cases

Repeater list contents	Used as an access repeater	Used as a destination repeater	Used for a <b>simplex</b> communication
NAME	–	–	–
SUB NAME	–	–	–
CALL SIGN	✓	✓	This item <b>MUST</b> be blank.
GW CALL SIGN (For Gateway call)	✓	✓	–
GROUP	–	–	–
USE(FROM)	✓	–	✓
FREQUENCY	✓	–	✓
DUP	✓	–	This item <b>MUST</b> be set to "OFF"
OFFSET FREQ	✓	–	–
POSITION	–	–	–
LATITUDE	–	–	–
LONGITUDE	–	–	–
<b>UTC</b> OFFSET	–	–	–

### ◇ New repeater programming

#### 1. Repeater group selection

- 1 Push [MENU] .
- 2 Push D-pad(↑) to select the root item ("DV Memory"), and then push D-pad(Ent).

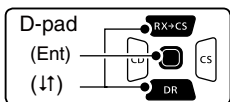

- 3 Push D-pad(↓) to select "Repeater List," and then push D-pad(Ent).
  - The repeater groups are displayed.
- 4 Push D-pad(↑) to select the desired repeater group to be programmed, and then push D-pad(Ent).
  - The repeater list of the selected repeater group is displayed.
- 5 Push [QUICK] .
- 6 Push D-pad(↓) to select "Add," and then push D-pad(Ent).
  - The REPEATER LIST EDIT screen is displayed.



\*When you want to add a new repeater by editing a programmed repeater memory contents, select "Edit." In this case, after programming, be sure to select "<<Add Write>>." If you select "<<Overwrite>>," the original repeater programmed contents are overwritten.

Continued on the next page.

■ Repeater list programming (Continued)

2. Repeater name programming

7 Push D-pad(↑) to select “NAME,” and then push D-pad(Ent) to enter the **repeater** name edit mode.

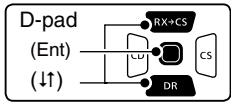

- 8 Rotate [DIAL] to select a desired character.
- Selectable input characters are Upper case letters, Lower case letters, Numbers or Symbols.
  - The selected character blinks.
  - Push D-pad(←) to move the cursor backward or forward.
  - While selecting a character, push [QUICK]([QUICK]([SPCH])) to change the character to an upper case or lower case letter.
  - While selecting a digit, push [QUICK]([QUICK]([SPCH])) to open the input mode selection window.
  - A space can be entered in any input mode selected.
  - Rotate [DIAL] counter clockwise to enter a space.
  - Push [CLR]([V/MHZ]([CLR]([LOW])) to delete the selected character, or hold down [CLR]([V/MHZ]([CLR]([LOW])) to continuously delete the characters, first to the right, and then to the left of the cursor.
  - See page 2-7 for programming details.
- 9 Push D-pad(→) to move the cursor to the second digit.
- 10 Repeat steps 8 and 9 to enter a name of up to 16 characters, including spaces.
- 11 After entering the name, push D-pad(Ent).

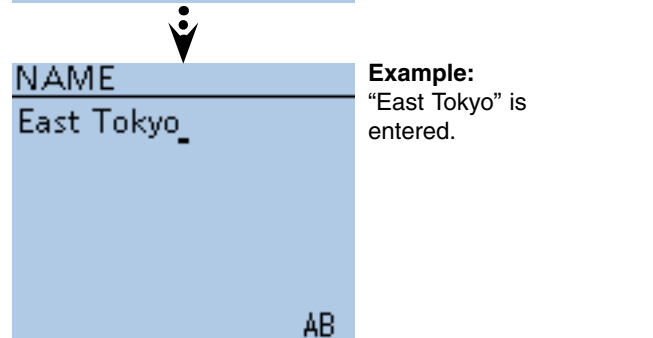
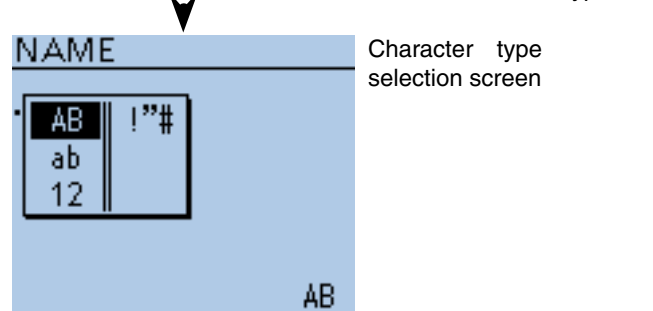
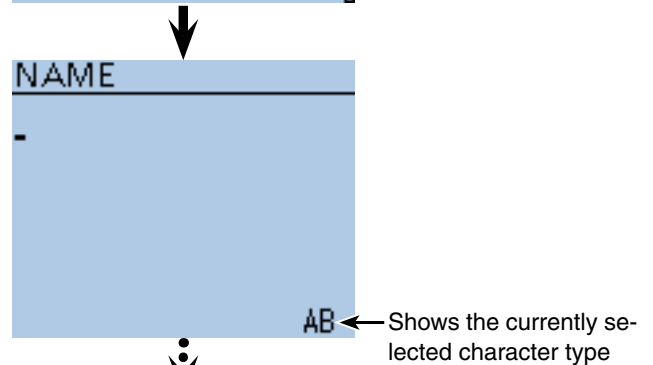
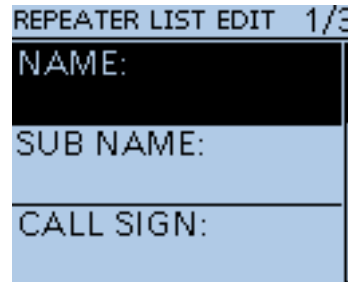

■ Repeater list programming (Continued)

3. Repeater sub name programming

12 Push D-pad(↑) to select “SUB NAME,” and then push D-pad(Ent) to enter the **repeater** sub name edit mode.

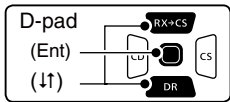

- 13 Rotate [DIAL] to select a desired character.
- Selectable input characters are Upper case letters, Lower case letters, Numbers or Symbols.
  - The selected character blinks.
  - Push D-pad(←) to move the cursor backward or forward.
  - While selecting a character, push [QUICK]([SPCH]) to change the character to an upper case or lower case letter.
  - While selecting a digit, push [QUICK]([SPCH]) to open the input mode selection window.
  - A space can be entered in any input mode selected.
  - Rotate [DIAL] counter clockwise to enter a space.
  - Push [CLR]([V/MHZ]) to delete the selected character, or hold down [CLR]([V/MHZ]) to continuously delete the characters, first to the right, and then to the left of the cursor.
  - See page 2-7 for programming details.
- 14 Push D-pad(→) to move the cursor to the second digit.
- 15 Repeat steps 13 and 14 to enter a sub name of up to 8 characters, including spaces.
- 16 After entering the name, push D-pad(Ent).

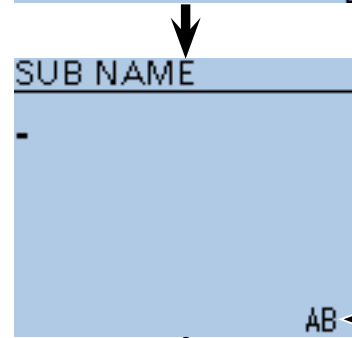
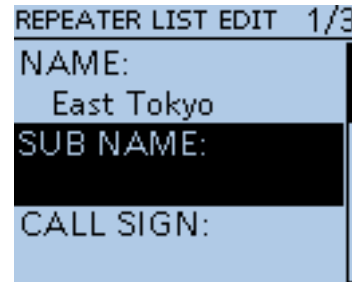

← Shows the currently selected character type

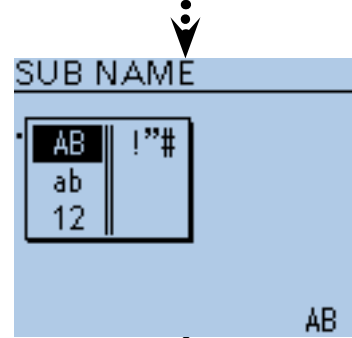

Character type selection screen

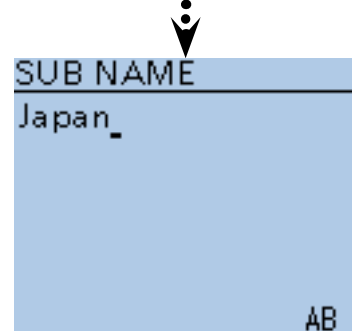

**Example:** “Japan” is entered.

■ Repeater list programming (Continued)

4. Repeater call sign programming

When used for **simplex** communication, go to [7. Access repeater setting].

17 Push D-pad(↑) to select “CALL SIGN,” and then push D-pad(Ent) to enter the **repeater** call sign edit mode.

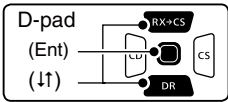

- 18 Rotate [DIAL] to select the first character.
  - A to Z, 0 to 9, / and a space can be selected.
  - A space can be entered in any input mode selected.
  - Push [CLR]<sup>V/MHz</sup><sub>CLR LOW</sub> to delete the selected character, or hold down [CLR]<sup>V/MHz</sup><sub>CLR LOW</sub> to continuously delete the characters, first to the right, and then to the left of the cursor.
- 19 Push D-pad(→) to move the cursor to the second digit.
- 20 Repeat steps 18 and 19 to enter a name of up to 8 characters, including spaces.
- 21 After entering the call sign, push D-pad(Ent).

✓ **Information**

Be sure to add a repeater node (port) letter as the 8th digit in the call sign field after a repeater call sign, according to the repeater frequency band, as shown below.

- Note that Japanese repeater node letters are different.
- 1200 MHz : A (B in Japan)
- 430 MHz : B (A in Japan)
- 144 MHz : C (no D-STAR repeaters in Japan)

Cross band operation between different nodes at the same repeater site can be made.

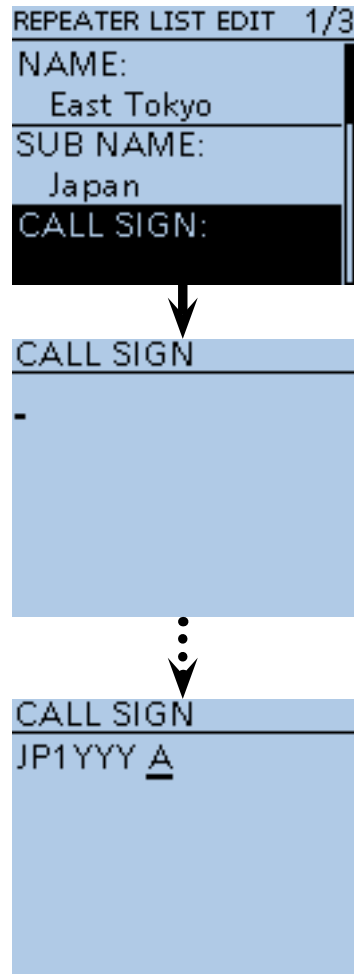

**Example:**  
“JP1YYY A” is entered.

■ Repeater list programming (Continued)

**5. Gateway repeater call sign programming**

The 8th digit in the call sign, programmed in [4. Repeater call sign programming] as described above, is automatically set to “G” as the gateway port. And you can skip this setting and go to the next item. If you need to change it, follow the steps, as described below.

22 Push D-pad(↑) to select “GW CALL SIGN,” and then push D-pad(Ent) to enter the gateway **repeater** call sign edit mode.

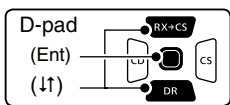

- 23 Rotate [DIAL] to select the first character.
  - A to Z, 0 to 9, / and a space can be selected.
  - A space can be entered in any input mode selected.
  - Push [CLR]<sup>(V/MHz)</sup><sub>(CLR LOW)</sub> to delete the selected character, or hold down [CLR]<sup>(V/MHz)</sup><sub>(CLR LOW)</sub> to continuously delete the characters, first to the right, and then to the left of the cursor.
- 24 Push D-pad(→) to move the cursor to the second digit.
- 25 Repeat steps 23 and 24 to enter a name of up to 8 characters, including spaces.
  - The 8th digit in the gateway repeater call sign is set to only “G” or a space.
- 26 After entering the gateway repeater call sign, push D-pad(Ent).

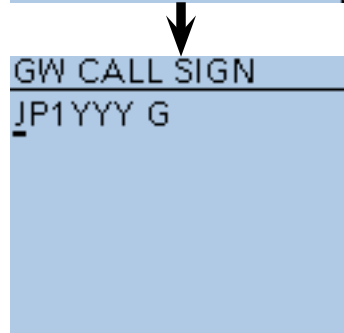

**Example:** “JP1YYY G” is entered.

**6. Repeater group viewing**

In this item, you can view the repeater group that is selected in [1. Repeater group selection]. And you can skip this setting and go to the next item. If necessary, you can change the repeater group.

- 27 Push D-pad(↑) to select “GROUP,” and then push D-pad(Ent) to enter the repeater group selection mode.
- 28 Push D-pad(↑) to select the desired repeater group (01 to 25), and then push D-pad(Ent).
  - The selected repeater group is displayed on the REPEATER LIST EDIT screen.



☞ Continued on the next page.



■ Repeater list programming (Continued)

**7. Access repeater setting**

The programmed repeaters can be used as an access repeaters in the DR mode.  
 For simplex operation, or when the programmed repeater is not used as an access repeater, select "NO." In this case, the programmed repeater does not appear in the "FROM" selection.

29 Push D-pad(↓) to select "USE(FROM)," and then push D-pad(Ent).

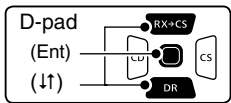

30 Push D-pad(↓) to select "YES," and then push D-pad(Ent).  
 • You can select the programmed repeater as an access repeater (FROM).

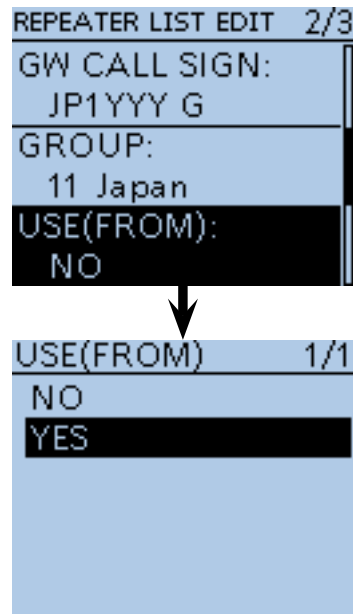

**8. Access repeater frequency programming**

This item appears only when "YES" is selected in [7. Access repeater setting].

- 31 Push D-pad(↓) to select "FREQUENCY," and then push D-pad(Ent) to enter the frequency edit mode.  
 • A cursor appears and blinks.
- 32 Rotate [DIAL] to input the 100 MHz digit of the frequency.
- 33 Push (←) to move the cursor backward, or push (→) to move the cursor forward.
- 34 Repeat steps 32 and 33 to enter the frequency.
- 35 After entering, push D-pad(Ent).

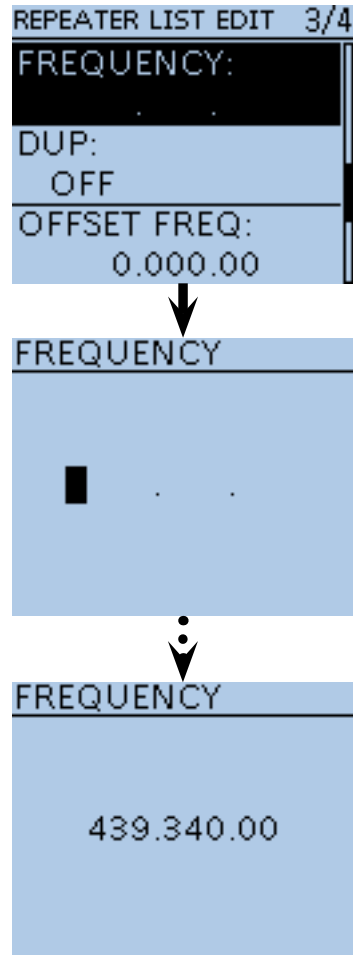

**Example:**  
 "439.340.00" is entered.

☞ Continued on the next page.

■ Repeater list programming (Continued)

**9. Duplex direction setting**

- This item appears only when “YES” is selected in [7. Access repeater setting].
- “DUP-” is automatically set when the access **repeater** frequency is programmed in [8. Access repeater frequency programming].
- If necessary, you can change the **duplex** direction.

36 Push D-pad(↓) to select “DUP;” and then push D-pad(Ent).

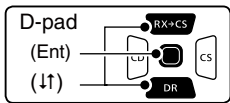

- 37 Push D-pad(↓) to select the duplex direction.
- OFF : Turn the duplex function OFF.  
For a **simplex** operation, this item MUST be set to “OFF.”
  - DUP- : The transmit frequency shifts down from the receive frequency by the offset amount.
  - DUP+ : The transmit frequency shifts up from the receive frequency by the offset amount.

38 After setting, push D-pad(Ent).

**10. Frequency offset programming**

- This item appears only when “YES” is selected in [7. Access repeater setting].
- The offset value\* is automatically set when the access repeater frequency is programmed in [8. Access repeater frequency programming].  
\*The default value differs, depending on the version.
- If necessary, you can change the **frequency offset**.

39 Push D-pad(↓) to select “OFFSET FREQ;” and then push D-pad(Ent) to enter the frequency offset edit mode.

- A cursor appears and blinks.

- 40 Rotate [DIAL] to input the frequency offset.
- 41 Push [←] to move the cursor backward, or push [→] to move the cursor forward.
- 42 Repeat steps 40 and 41 to enter the frequency offset.
- 43 After entering, push D-pad(Ent).

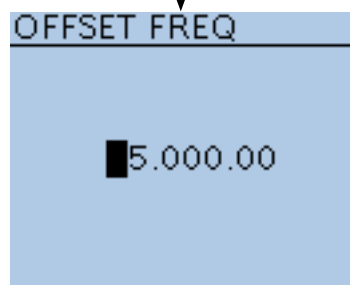
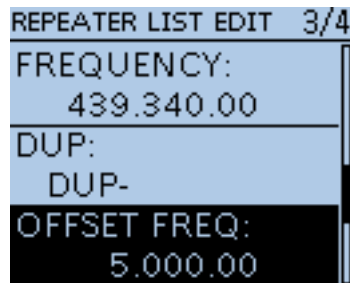
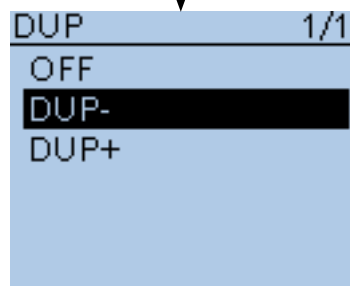
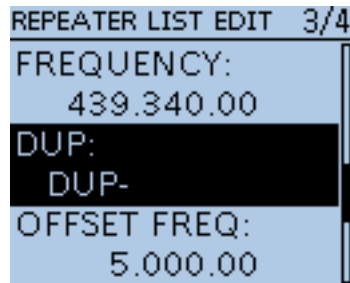

■ Repeater list programming (Continued)

**11. Position data accuracy level setting**

When the Repeater Search function is not used, or the distance between your position and a **repeater** is not displayed, select “OFF.”

44 Push D-pad(↑) to select “POSITION,” and then push D-pad(Ent).

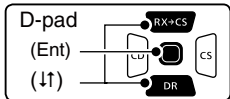

45 Push D-pad(↑) to select the position data accuracy level.

- None : Select when the repeater has no position data.
- Approximate : Select when the programmed position data is approximate.
- Exact : Select when the programmed position data is exactly correct.

46 After setting, push D-pad(Ent).

**12. Latitude programming**

This item appears only when “Approximate” or “Exact” is selected in [11. Position data accuracy level setting].

47 Push D-pad(↑) to select “LATITUDE,” and then push D-pad(Ent) to enter the latitude data edit mode.

- A cursor appears and blinks.

48 Rotate [DIAL] to input the latitude.

49 Push ⏪ to move the cursor backward, or push ⏩ to move the cursor forward.

50 Repeat steps 48 and 49 to enter the latitude.

51 After entering, push D-pad(Ent).

**13. Longitude programming**

This item appears only when “Approximate” or “Exact” is selected in [11. Position data accuracy level setting].

52 Push D-pad(↑) to select “LONGITUDE,” and then push D-pad(Ent) to enter the longitude data edit mode.

- A cursor appears and blinks.

53 Rotate [DIAL] to input the longitude.

54 Push ⏪ to move the cursor backward, or push ⏩ to move the cursor forward.

55 Repeat steps 53 and 54 to enter the longitude.

56 After entering, push D-pad(Ent).

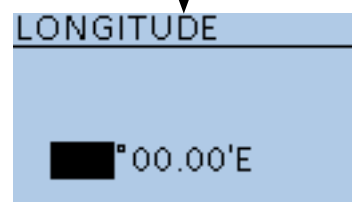
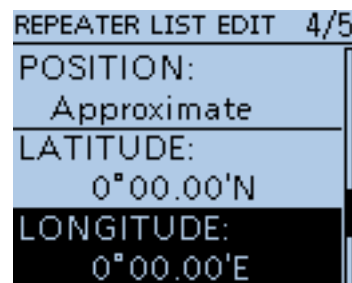
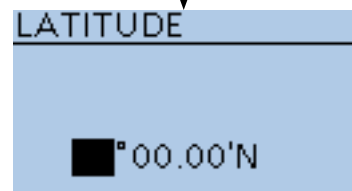
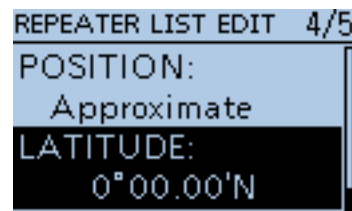
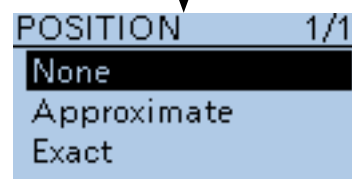
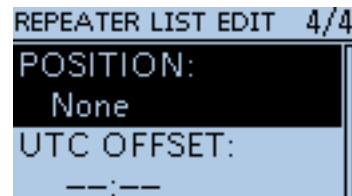

☞ Continued on the next page.

■ Repeater list programming (Continued)

14. UTC Offset programming

UTC (Universal Time Coordinated) offset is the time difference between UTC and **repeater** local time. This item enables you to check the destination repeater's time when you make a gateway call. (p. 9-39)

57 Push D-pad(↓) to select "UTC OFFSET," and then push D-pad(Ent) to enter the UTC offset edit mode.

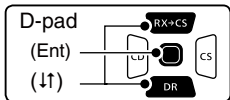

58 Rotate [DIAL] to input the time difference between UTC and the local time.

59 After entering, push D-pad(Ent).



15. Storing the repeater list

60 Push D-pad(↓) to select "<<Add Write>>," and then push D-pad(Ent).

61 Push D-pad(↑) to select "YES," and then push D-pad(Ent).  
 • The programmed contents are stored to the repeater list, and the display returns to the RPT LIST screen.

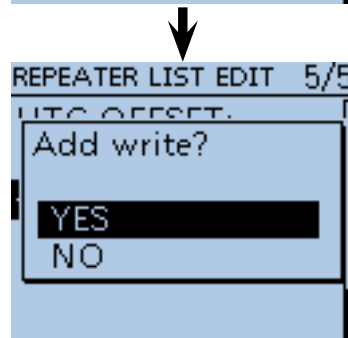
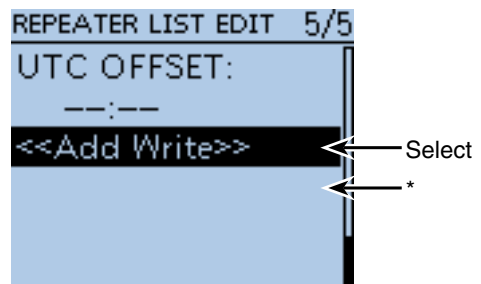

**To cancel the programmed data:**

To cancel the programmed data, push [CLR] <sup>V/MHz</sup> <sub>CLR LOW</sub> to display "Cancel edit?." Push D-pad(↑) to select "YES," and then push D-pad(Ent) to cancel programming and the display returns the RPT LIST screen.

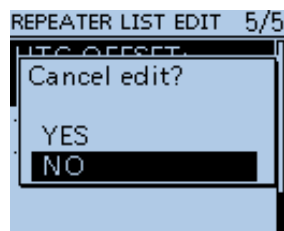



\* "<<Overwrite>>" appears when "Edit" is selected in [1. Repeater group selection].

## ■ Editing a repeater list

This function reprograms a **repeater**'s data. This is useful when already-programmed data is incorrect, has changed or some data should be added to the list.

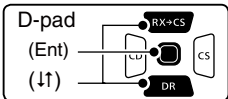
- ① Push [MENU] .
- ② Push D-pad(↑) to select the root item (“DV Memory”), and then push D-pad(Ent).



- ③ Push D-pad(↓) to select “Repeater List,” and then push D-pad(Ent).
- ④ Push D-pad(↓) to select the repeater group that includes the repeater you want to edit, and then push D-pad(Ent).
- ⑤ Push D-pad(↓) to select the repeater to be edited.
- ⑥ Push [QUICK] .
- ⑦ Push D-pad(↓) to select “Edit.”
- ⑧ Push D-pad(↓) to select the desired item, and then push D-pad(Ent).
  - See pages 9-23 to 9-31 for programming details.
- ⑨ After programming, the display returns to the REPEATER LIST EDIT screen.
- ⑩ Push D-pad(↓) to select “<<Overwrite>>,” and then push D-pad(Ent).
- ⑪ Push D-pad(↓) to select “YES,” and then push D-pad(Ent).
  - The programmed contents are overwritten on the repeater list, and the display returns the RPT LIST screen.

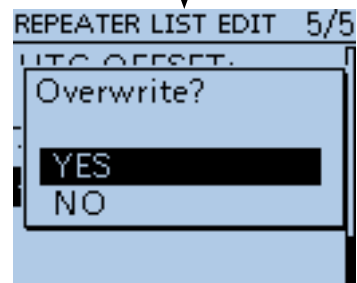
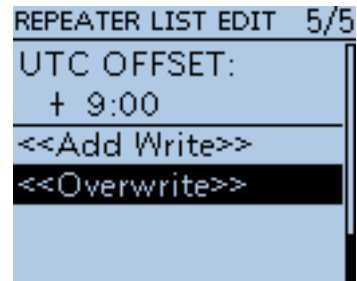



**Example:**  
“East Tokyo” is edited.

## ■ Deleting a repeater list

The programmed **repeater** contents can be deleted from the repeater list.

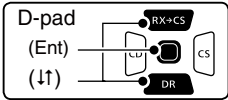
- ① Push [MENU] .
- ② Push D-pad(↑) to select the root item (“DV Memory”), and then push D-pad(Ent).



- ③ Push D-pad(↓) to select “Repeater List,” and then push D-pad(Ent).
  - ④ Push D-pad(↓) to select the repeater group that includes the repeater you want to delete, and then push D-pad(Ent).
  - ⑤ Push D-pad(↓) to select the repeater to be deleted.
  - ⑥ Push [QUICK] .
  - ⑦ Push D-pad(↓) to select “Delete,” and then push D-pad(Ent).
  - ⑧ Push D-pad(↓) to select “YES,” and then push D-pad(Ent).
- The programmed repeater contents are deleted from the repeater list, and the display returns to the RPT LIST screen.

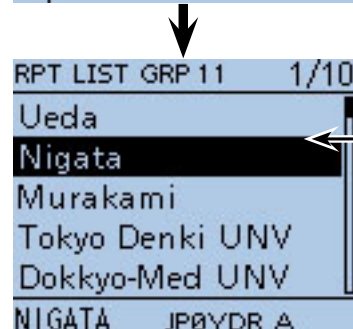
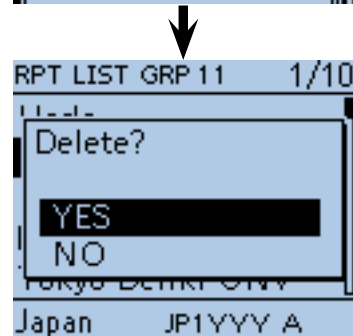
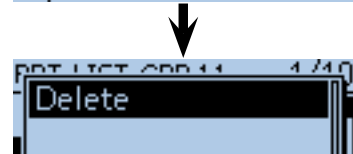
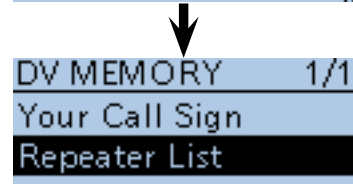
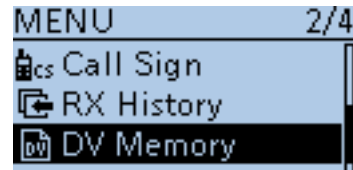



**Example:**  
“East Tokyo” is deleted.

## ■ Rearrange the display order of the repeater

You can move the programmed **repeaters** to rearrange their display order in the selected repeater group. The programmed repeater cannot be moved out of their assigned repeater group.

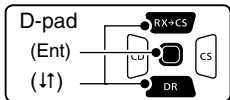
- ① Push [MENU] .
- ② Push D-pad(↑) to select the root item (“DV Memory”), and then push D-pad(Ent).



- ③ Push D-pad(↑) to select “Repeater List,” and then push D-pad(Ent).
- ④ Push D-pad(↑) to select the repeater group that includes the repeater you want to move, and then push D-pad(Ent).
- ⑤ Push D-pad(↑) to select the repeater to be moved.
- ⑥ Push [QUICK] .
- ⑦ Push D-pad(↑) to select “Move,” and then push D-pad(Ent).
  - “DESTINATION” blinks on the upper left of the LCD.
- ⑧ Push D-pad(↑) to select the location to insert the repeater you want to move, which will be above the memory name selected in this screen, and then push D-pad(Ent).
  - The selected repeater is inserted to above the destination repeater name.
  - When “<<Move End>>” is selected, the selected repeater is moved to the bottom of the repeater group.

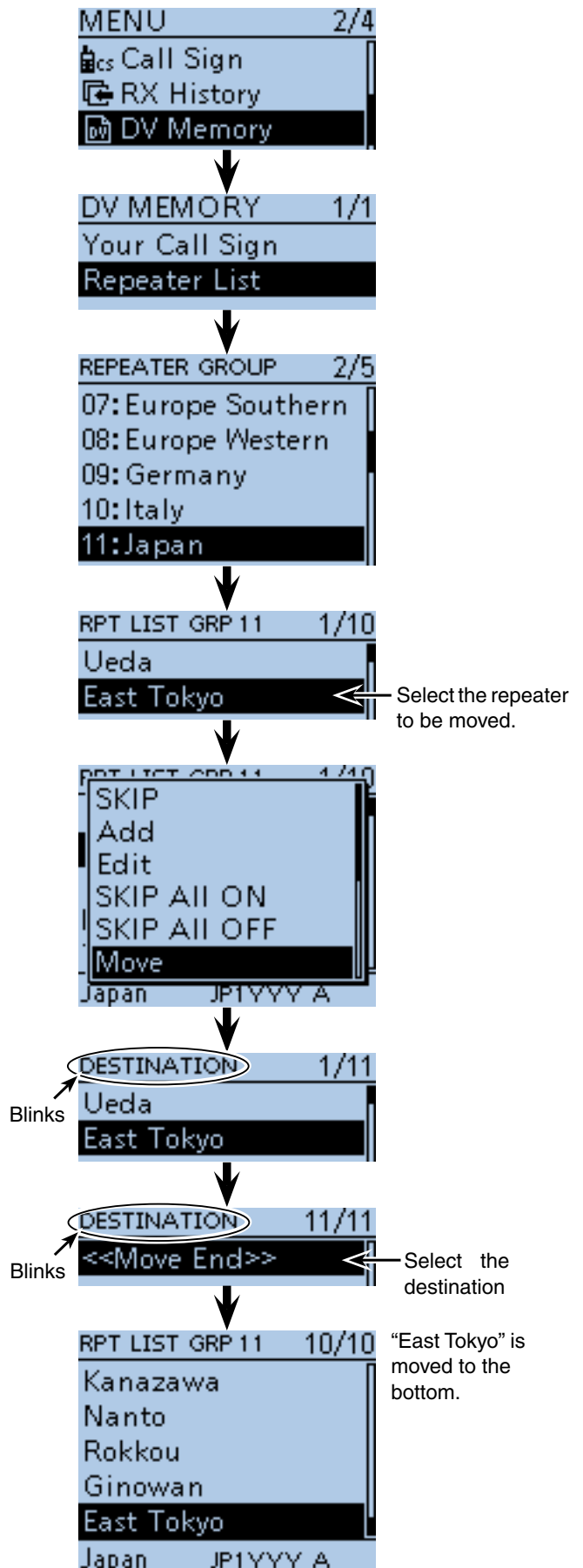

## ■ Adding the Repeater information using the RX History

This section describes how to add a new **repeater** information to the repeater list using the RX history.

- ① Push [MENU] .
- ② Push D-pad(↑) to select the root item ("RX History"), and then push D-pad(Ent).

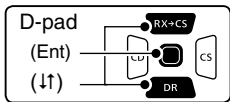

- ③ Push D-pad(↑) to select the RX history number that includes the repeater you want to add to the repeater list.
- ④ Push D-pad(Ent).
  - The RX history detail screen is displayed.
- ⑤ Push D-pad(↑) to display "RXRPT1" and "RXRPT2."
- ⑥ Push [QUICK] .
- ⑦ Push D-pad(↑) to select "Add To RPT List," and then push D-pad(Ent).
- ⑧ Push D-pad(↑) to select the repeater call sign you want to add to the repeater list, and then push D-pad(Ent).
  - When only one call sign is displayed, directly push D-pad(Ent).
  - The display is switched from the RX HISTORY screen to the REPEATER LIST EDIT screen of the MENU. The selected repeater call sign is automatically programmed.
  - If necessary, edit the contents. (pp. 9-22 to 9-31)
- ⑨ Push D-pad(↑) to select "<<Add To RPT List>>," and then push D-pad(Ent).
- ⑩ Push D-pad(↑) to select "YES," and then push D-pad(Ent).
  - The programmed contents are added to the repeater list, and the display returns to the RX HISTORY screen.

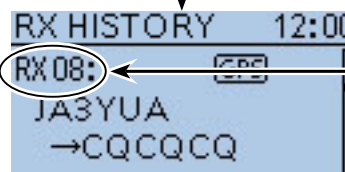
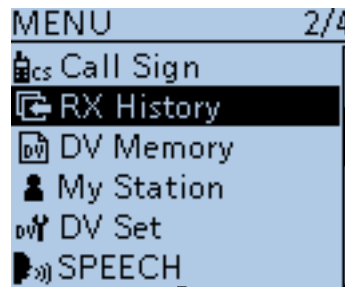

RX history number

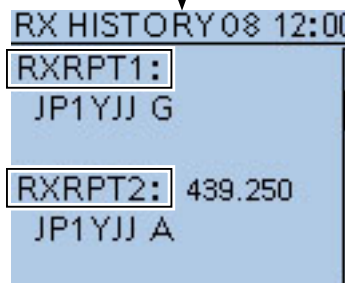
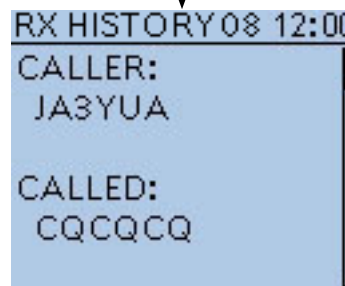

"RXRPT1" and "RXRPT2" are displayed.

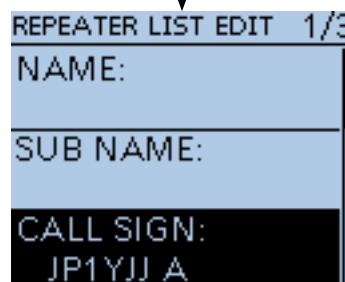

**Example:**  
"JP1YJJ A" is added.

### How to switch the name display:

When the call sign is displayed on the RX HISTORY screen, you can switch the display type to "Name Display."

When the repeater name is not programmed in the repeater list, the display does not switch to the name display. It is convenient that you find a repeater that is not included in the repeater list.

- When the RX HISTORY screen is displayed, push [QUICK]  to display the Quick menu. Push D-pad(↑) to select "Name Display," and then push D-pad(Ent).

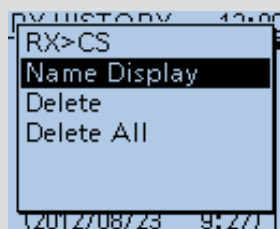



## ■ Skip setting for the DR mode scan

You can set unnecessary repeaters as scan skip targets. The selected repeaters are skipped during scanning for faster selection and scanning.



You can set the skip setting to all repeaters in the selected repeater group, or the individual repeater.

When a repeater is specified as a skip target, its "USE (FROM)" setting is automatically set to "NO." In this case, the repeater cannot be selected in "FROM" (Access repeater).

### ◆ Individual skip setting

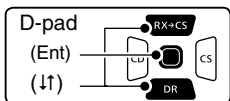
- ① Push [MENU] .
- ② Push D-pad(↑) to select the root item ("DV Memory"), and then push D-pad(Ent).



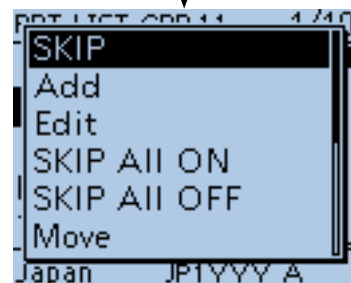
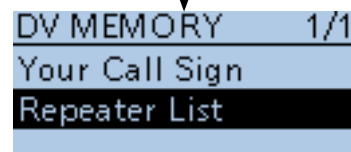
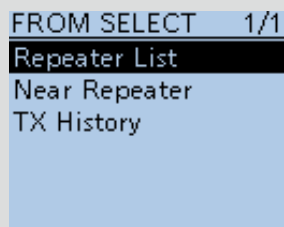

- ③ Push D-pad(↑) to select "Repeater List," and then push D-pad(Ent).
- ④ Push D-pad(↑) to select the repeater group that includes the repeater you want to set the skip setting on, and then push D-pad(Ent).
- ⑤ Push D-pad(↑) to select the repeater to be skipped during the DR mode scan.
- ⑥ Push [QUICK] .
- ⑦ Push D-pad(↑) to select "SKIP," and then push D-pad(Ent).
  - "SKIP" appears on the selected repeater.
  - Push [QUICK]  and select "SKIP" again, then push D-pad(Ent) to cancel the skip setting.
  - When "SKIP All ON" is selected, push D-pad(Ent) to set all repeaters in the group as skip targets.

While in the DR mode, and if you select "Repeater List" on the FROM SELECT screen, you can set the skip settings in the same way as described above.



■ Skip setting for the DR mode scan (Continued)

◇ Group skip setting

- ① Push [MENU] .
- ② Push D-pad(↑) to select the root item (“DV Memory”), and then push D-pad(Ent).
- ③ Push D-pad(↑) to select “Repeater List,” and then push D-pad(Ent).
- ④ Push D-pad(↑) to select the **repeater** group to be skipped during the DR mode scan.
- ⑤ Push [QUICK] .
- ⑥ Push D-pad(↑) to select “SKIP All ON,” and then push D-pad(Ent).
  - “SKIP” appears on the selected repeater group.
  - Push [QUICK]  again and select “SKIP All OFF;” then push D-pad(Ent) to cancel the skip setting.

While in the DR mode, and if you select “Repeater List” on the FROM SELECT screen, you can set the skip settings in the same way as described above.

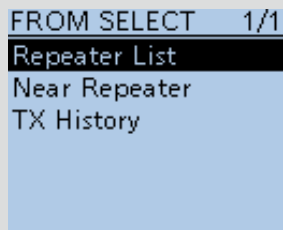

Select the repeater group to set the skip setting

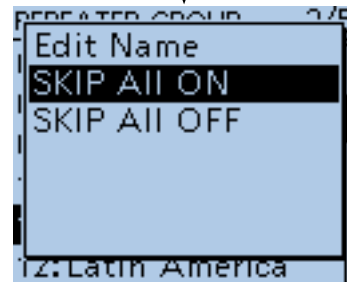



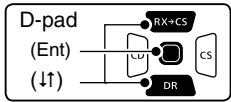

Appears

## ■ Repeater group name programming

- ① Push [MENU] .
- ② Push D-pad(↑) to select the root item (“DV Memo-ry”), and then push D-pad(Ent).



- ③ Push D-pad(↓) to select “Repeater List,” and then push D-pad(Ent).
- ④ Push D-pad(↓) to select the **repeater** group you want to program the name.
- ⑤ Push [QUICK] .
- ⑥ Push D-pad(↓) to select “Edit Name,” and then push D-pad(Ent) to enter the group name edit mode.
- ⑦ Rotate [DIAL] to select a desired character.
  - Selectable input characters are Upper case letters, Lower case letters, Numbers or Symbols.
  - The selected character blinks.
  - Push D-pad(←) to move the cursor backward or forward.
  - While selecting a character, push [QUICK]  to change the character to an upper case or lower case letter.
  - While selecting a digit, push [QUICK]  to open the input mode selection window.
  - A space can be entered in any input mode selected.
  - Rotate [DIAL] counter clockwise to enter a space.
  - Push [CLR]  to delete the selected character, or hold down [CLR]  to continuously delete the characters, first to the right, and then to the left of the cursor.
  - See page 2-7 for programming details.
- ⑧ Push D-pad(→) to move the cursor to the second digit.
- ⑨ Repeat steps ⑦ and ⑧ to enter a name of up to 16 characters, including spaces.
- ⑩ After entering, push D-pad(Ent) two times.

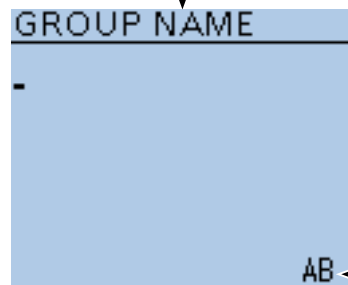
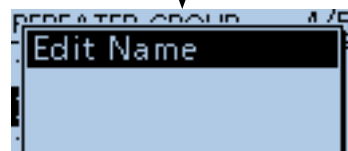
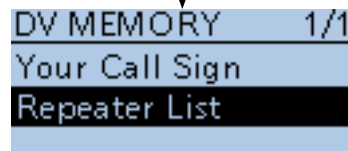
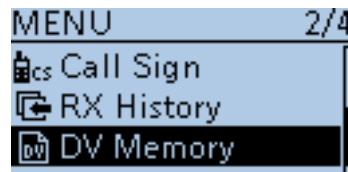

Groupname edit mode

← Shows the currently selected character type



Character type selection screen

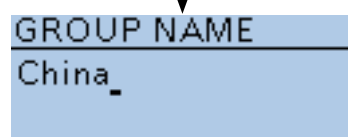

**Example:** “China” is programmed.

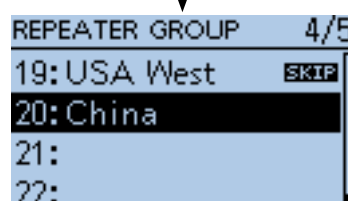

## ■ Repeater detail screen

According to the programmed contents, such as position data, UTC offset, and so on, the distance between your position and the repeater or repeater time can be displayed on the REPEATER DETAIL screen.

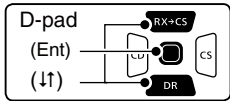
- ① Hold down **DR** for 1 second.
    - The DR mode is selected.
  - ② Push D-pad(↑) to select “TO,” and then push D-pad(Ent).
- 
- ③ Push D-pad(↓) to select “Gateway CQ,” and then push D-pad(Ent).
  - ④ Push D-pad(↓) to select the repeater group, and then push D-pad(Ent).
    - Example: “11: Japan”
  - ⑤ Push D-pad(↓) to select the repeater, and then push D-pad(Ent).
    - Example: “Hirano”
  - ⑥ Push **[QUICK]**<sup>QUICK</sup><sub>SPCH</sub>.
  - ⑦ Push D-pad(↑) to select “Detail,” and then push D-pad(Ent).
    - The REPEATER DETAIL screen is displayed.
  - ⑧ Push D-pad(Ent) to return to the RPT LIST screen.

**Example:** Shows the “Hirano” repeater detail screen



While in the DR mode, and if you set the repeater as shown to the right, the repeater details screen can be displayed.

- ① Push **[QUICK]**<sup>QUICK</sup><sub>SPCH</sub> to open the quick menu screen.
- ② Push D-pad(↑) to select “Repeater Detail,” and then push D-pad(Ent).
  - The REPEATER DETAIL screen is displayed.

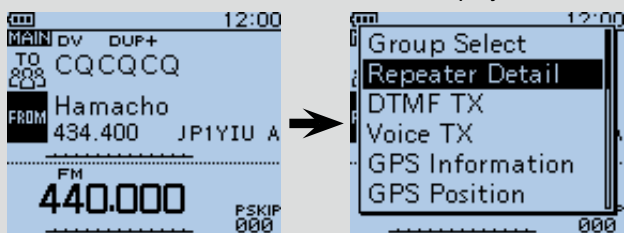

Repeater is set in “FROM” “Repeater Detail” is selected

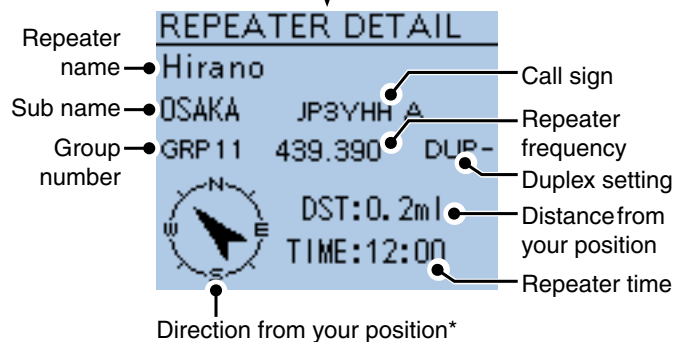

\* When the position data accuracy level is set to “Approximate,” direction data is not displayed if the distance to the repeater is under 5 kilometers.

## ■ Your (destination) call sign programming





A Your (destination) call sign can be manually programmed.

The Your (destination) call sign is set to “TO,” you can make a call to a station, even if you don’t know where the station is currently located.

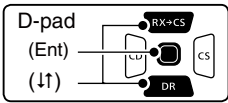
Up to 200 Your call signs can be programmed.

- ① Push [MENU] .
- ② Push D-pad(↑) to select the root item (“DV Memory”), and then push D-pad(Ent).



- ③ Push D-pad(↑) to select “Your Call Sign,” and then push D-pad(Ent).
- ④ Push [QUICK] .
- ⑤ Push D-pad(↑) to select “Add,” and then push D-pad(Ent) to enter the edit mode.
- ⑥ Push D-pad(↑) to select “NAME,” and then push D-pad(Ent).
- ⑦ Rotate [DIAL] to select a desired character.
  - (For example: T)
    - Selectable input characters are Upper case letters, Lower case letters, Numbers or Symbols.
    - The selected character blinks.
    - Push D-pad(←) to move the cursor backward or forward.
    - While selecting a character, push [QUICK]  to change the character to an upper case or lower case letter.
    - While selecting a digit, push [QUICK]  to open the input mode selection window.
    - A space can be entered in any input mode selected.
    - Rotate [DIAL] counter clockwise to enter a space.
    - Push [CLR]  to delete the selected character, or hold down [CLR]  to continuously delete the characters, first to the right, and then to the left of the cursor.
    - See page 2-7 for programming details.
- ⑧ Push D-pad(→) to move the cursor to the second digit.
- ⑨ Repeat steps ⑦ and ⑧ to enter a name of up to 16 characters, including spaces.
  - (For example: First, T, then O, then M.)
- ⑩ After entering, push D-pad(Ent) two times.

**Example:** Program “TOM/JM1ZLK” to the Your Call Sign memory.

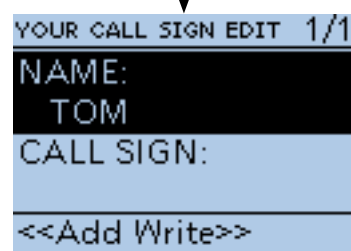
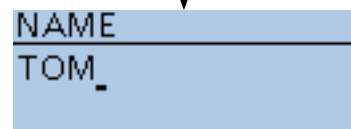
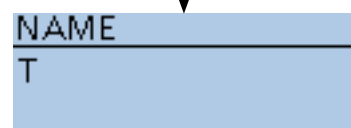
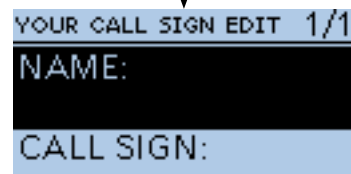
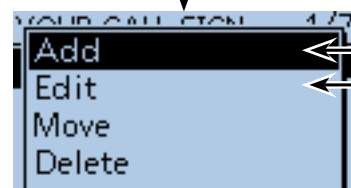
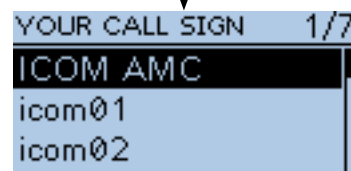
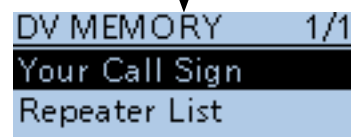
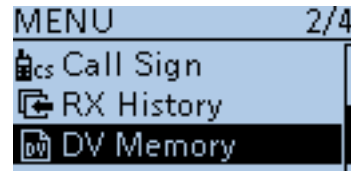

“TOM” is entered.

Continued on the next page

■ Your (destination) call sign programming (Continued)

- ⑪ Push D-pad(⬇️) to select “CALL SIGN,” and then push D-pad(Enter).
- ⑫ Rotate [DIAL] to select the first character.  
(For example: J)
  - A to Z, 0 to 9, / and a space can be selected.
  - A space can be entered in any input mode selected.
  - Push [CLR] <sup>V/MHZ</sup> <sub>CLR LOW</sub> to erase the selected character, or hold down [CLR] <sup>V/MHZ</sup> <sub>CLR LOW</sub> to continuously erase the characters after the cursor.
- ⑬ Push D-pad(➡️) to move the cursor to the second digit.
- ⑭ Repeat steps ⑫ and ⑬ to enter a call sign of up to 8 characters, including spaces.  
(For example: First, J, then M, then 1, then Z, then L, then K.)
- ⑮ After entering, push D-pad(Enter).
- ⑯ Push D-pad(⬇️) to select “<<Add Write>>,” and then push D-pad(Enter).
- ⑰ Push D-pad(⬆️) to select “YES,” and then push D-pad(Enter).
- ⑱ Push [MENU] <sup>MENU</sup> <sub>PRO</sub> to exit the MENU screen.

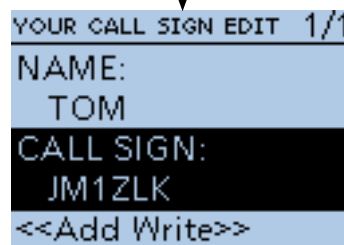
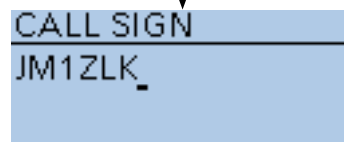
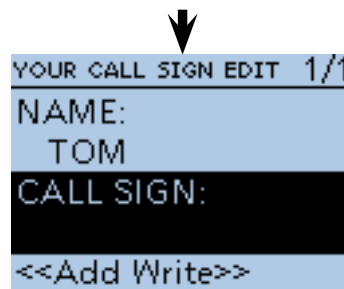
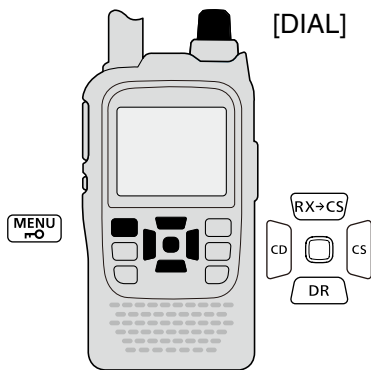

“JM1ZLK” is entered.



When you select “Edit” in step ⑤ on the previous page “<<Overwrite>>” appears here. If you select “<<Overwrite>>,” the programmed call sign overwrites the original call sign.

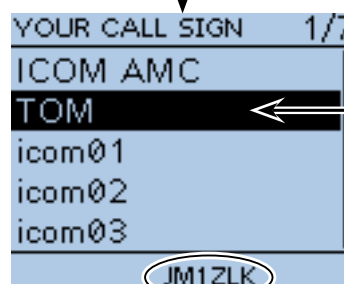
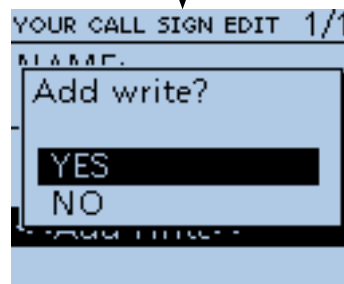

When “TOM” is selected, “JM1ZLK” is displayed here.

**To cancel the programmed data:**

To cancel the programmed data, push [CLR] <sup>V/MHZ</sup> <sub>CLR LOW</sub> to display “Cancel edit?.” Push D-pad(⬆️) to select “YES,” and then push D-pad(Enter) to cancel programming and the display returns the YOUR CALL SIGN screen.

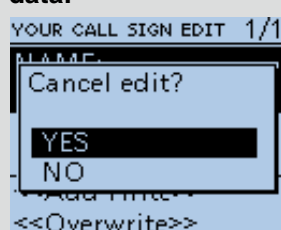

## ■ Deleting Your (destination) call sign

The Your (destination) call signs can be deleted from the Your Call Sign memory.

- ① Push [MENU] .
- ② Push D-pad(↑) to select the root item (“DV Memory”), and then push D-pad(Ent).

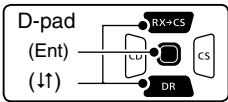

- ③ Push D-pad(↑) to select “Your Call Sign,” and then push D-pad(Ent).
- ④ Push D-pad(↑) to select the Your call sign you want to delete.
- ⑤ Push [QUICK] .
- ⑥ Push D-pad(↑) to select “Delete,” and then push D-pad(Ent).
- ⑦ Push D-pad(↓) to select “YES,” and then push D-pad(Ent).
  - The selected call sign is deleted from the memory, and the display returns the YOUR CALL SIGN screen.

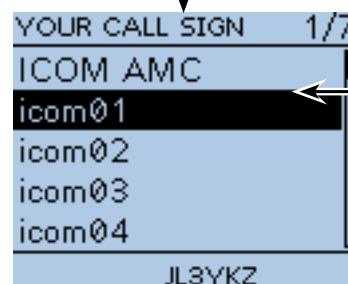
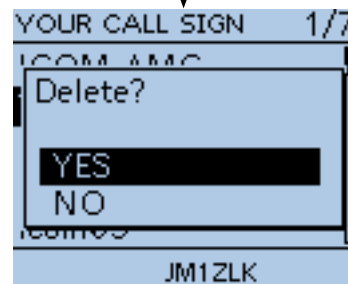
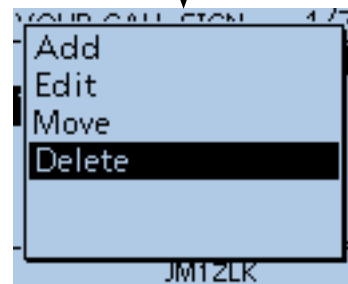
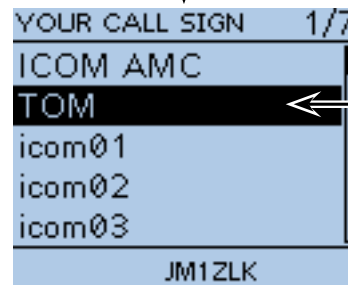
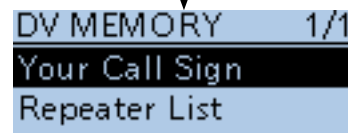
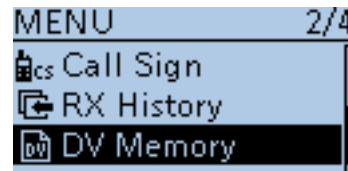



## ■ Rearrange the display order of Your (destination) call sign

You can move Your call signs to rearrange their display order.

It is easy to find stations that you often communicate if the stations are moved to the top of the memory.

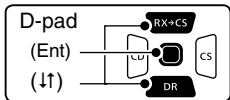
- ① Push [MENU] .
- ② Push D-pad(↑) to select the root item (“DV Memory”), and then push D-pad(Ent).



- ③ Push D-pad(↑) to select “Your Call Sign,” and then push D-pad(Ent).
- ④ Push D-pad(↑) to select the call sign you want to move.
- ⑤ Push [QUICK] .
- ⑥ Push D-pad(↑) to select “Move,” and then push D-pad(Ent).
  - “DESTINATION” blinks on the upper left of the LCD.
- ⑦ Push D-pad(↑) to select the location to insert the call sign you want to move, which will be above the memory name selected in this screen, and then push D-pad(Ent).
  - The selected call sign is inserted to above the destination.
  - When “<<Move End>>” is selected, the selected call sign is moved to the bottom of the YOUR CALL SIGN screen.

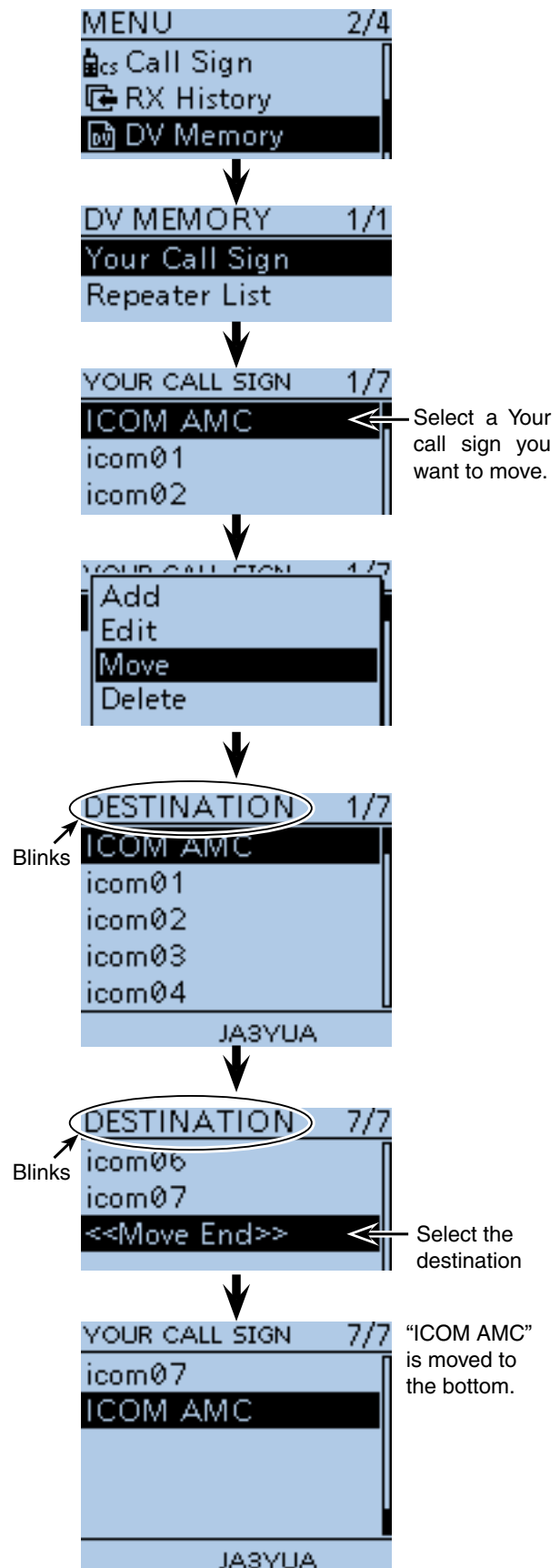



## ■ About the repeater list default values

You can check the **repeater** list default values using the supplied CS-51 CLONING SOFTWARE.

The ICF (Icom Cloning Format) file, including the default repeater list, can also be downloaded from the Icom website.

<http://www.icom.co.jp/world/support/download/firm/index.html>

If you open the downloaded ICF file with the CS-51, the repeater list default values are displayed on the screen.

To reset the programmed repeater list to the default, write the ICF file to the transceiver using the CS-51\*1, or copy the ICF file to the microSD card\*2, and then write to the transceiver.

\*1 See the CS-51 instruction manual when using the CS-51.

\*2 See page 2-9 when using the microSD card.

### ◇ Opening the default repeater list

- ① Start the CS-51.
  - See the CS-51 instruction manual for how to install the software.
- ② Click [Open] to open the ICF file.
- ③ Click the [Repeater list] folder to show the default repeater list.

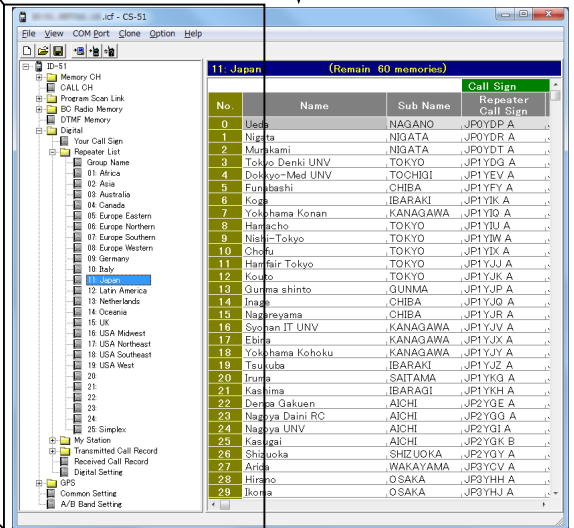
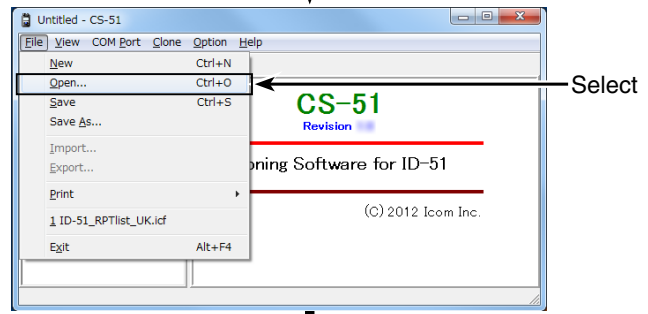
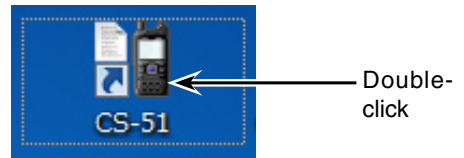
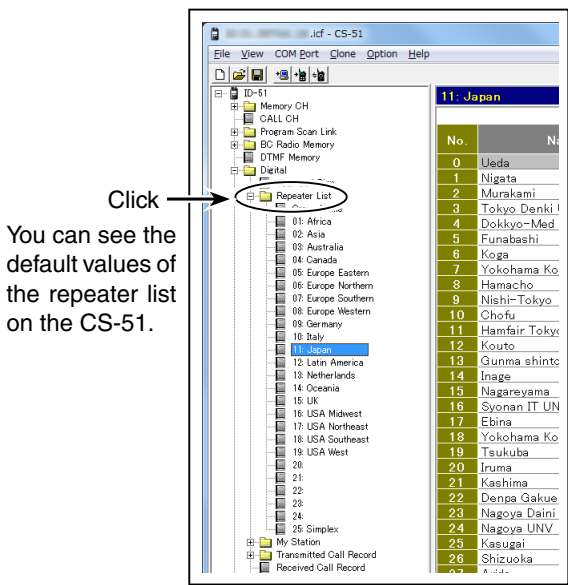

When the ICF file is opened on the CS-51.

## ■ Your setting is correct?

If you make a Local Area call with the Gateway call setting, the destination **repeater**, selected in “TO,” will be busy while you transmit.

So the station that uses that repeater as their Access repeater cannot access it, as shown below.

**BE SURE** to set CQCQCQ in “TO” when you intend to make a local call, or after you finish a Gateway call.

Example: JM1ZLK wants to make a Local Area call.

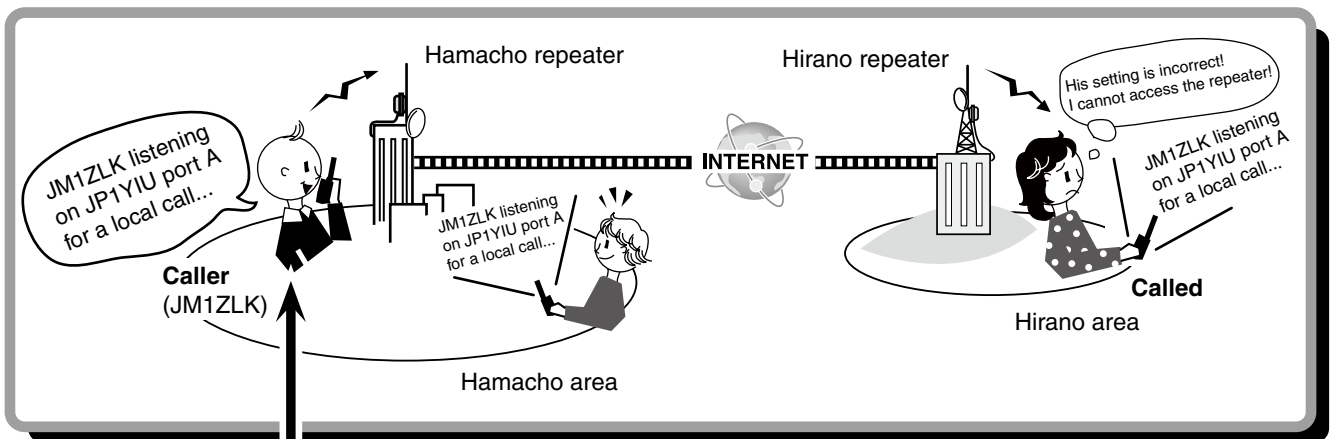

JM1ZLK's setting



The destination (“TO”) setting is incorrect.

Correct setting

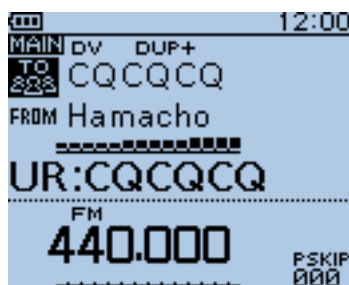

To make a Local Area call, set the destination (“TO”) to “CQCQCQ.” See page 8-9 for details.

**NOTE:** With this setting, the Local Area call can be made, but the destination repeater, selected in “TO,” is also busy while you transmit. So the station that uses that repeater as their Access repeater cannot access it.

# Section 10 GPS/GPS-A OPERATION

---

- GPS operation ..... 10-2
  - ◇ Receiving GPS data ..... 10-2
- Checking GPS Position ..... 10-3
  - ◇ Displaying Position Data..... 10-3
  - ◇ Changing the Grid Locator ..... 10-4
  - ◇ Changing the Compass Direction..... 10-4
  - ◇ Saving your own or received position data.... 10-5
- Checking GPS Information (Sky view screen)... 10-6
- Adding or editing GPS memory ..... 10-7
  - ◇ GPS Memory ..... 10-7
  - ◇ Add a GPS memory ..... 10-7
  - ◇ GPS group name programming..... 10-11
  - ◇ Deleting GPS data..... 10-12
  - ◇ Rearrange the display order of the  
GPS memory..... 10-13
  - ◇ GPS alarm setting ..... 10-14
- Transmitting GPS data..... 10-16
  - ◇ GPS data sentence setting..... 10-16
  - ◇ GPS message programming ..... 10-17
- Transmitting GPS-A data ..... 10-18
  - ◇ D-PRS ..... 10-18
  - ◇ Operating GPS-A ..... 10-18
  - ◇ Setting GPS-A ..... 10-19
  - ◇ Displaying your position using a mapping  
software..... 10-23
- GPS Auto transmission for only Simplex ..... 10-24
  - ◇ Setting the GPS automatic transmission ..... 10-24
- GPS Logger function ..... 10-25
  - ◇ GPS Logger operating outline ..... 10-25
  - ◇ GPS Logger operation..... 10-25
  - ◇ Turning ON the GPS Logger function..... 10-26
  - ◇ Setting the GPS record interval..... 10-26
  - ◇ Viewing the route on a PC Map..... 10-27
  - ◇ Using <<GPS Logger Only>> mode..... 10-29

## ■ GPS operation

The ID-51A/E has a built-in internal GPS receiver. The GPS receiver's position information can be received in any mode. Also, a NMEA format compatible external GPS receiver can be connected to the ID-51A/E through the [DATA] port.

### ◇ Receiving GPS data

- ① Push [MENU] .
- ② Push D-pad(↓) to select the root item ("GPS"), and then push D-pad(Ent) to go to the next screen.

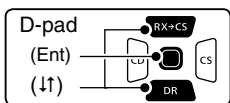

(MENU > GPS > GPS Set > **GPS Select**)

- ③ Refer to the menu sequence shown directly above and push D-pad(↓) to select, and then D-pad(Ent) to enter, one or more times until the last screen is displayed.
- ④ Push D-pad(↓) to select "Internal GPS."
  - If an external GPS receiver is connected, select "External GPS."
- ⑤ Push [MENU]  to exit the Menu screen.

• The GPS icon blinks when receiving data, as illustrated below, and stops blinking when valid data is received.

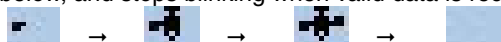

- If "Manual" was selected, the icon does not appear.
- It may take only a few seconds to receive, but depending on the environment, it may take a few minutes. If you have difficulties receiving, we recommend that you try a different location.

**NOTE:** While continuously using the Internal GPS mode, the transceiver's battery will quickly be exhausted. Longer battery time can be achieved by turning ON the Power Save mode. See page 16-32 for details.  
 (MENU > GPS > GPS Set > **Power Save (Internal GPS)**)

#### To prolong the battery life in the GPS mode

To prolong the battery life while operating in the GPS mode, manually update your position with the received GPS data.

- ① Set the "GPS Select" option to "Internal GPS," and receive your position from the internal GPS receiver. (MENU > GPS > GPS Set > **GPS Select**)
- ② Open the MANUAL POSITION screen, and then push [QUICK] .
- ③ D-pad(↓) to select "Capture From GPS," and then push D-pad(Ent).
- Your current position is now memorized and displayed on the MANUAL POSITION screen.
- ④ After that, set the "GPS Select" option to "Manual."

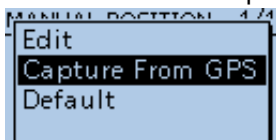

To receive signals from an external GPS source, connect an external NMEA format compatible receiver to the ID-51A/E according to the instructions, shown below. The cable is not an Icom product and must be made separately. Refer to the wiring diagram for pin connections.

- Position data can be transmitted in only the DV mode.

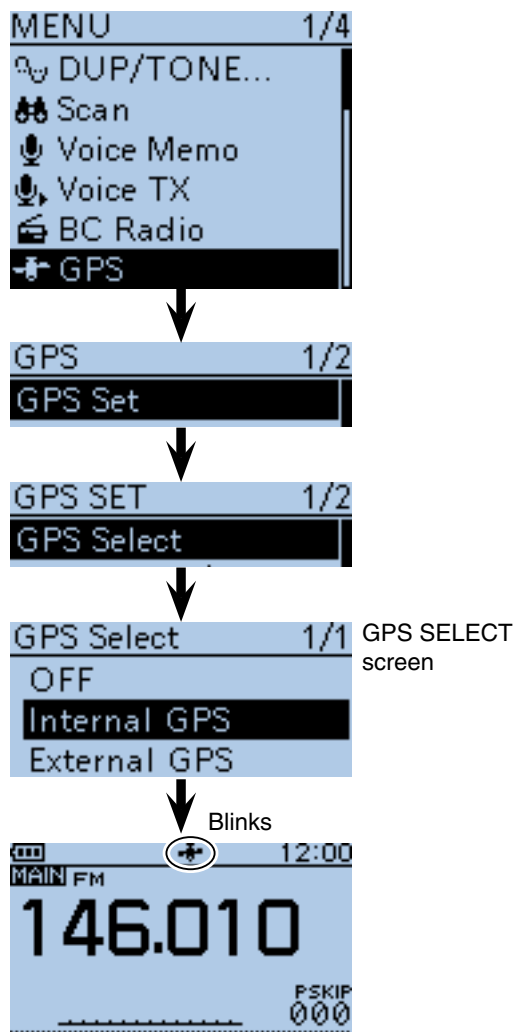

#### • Connection

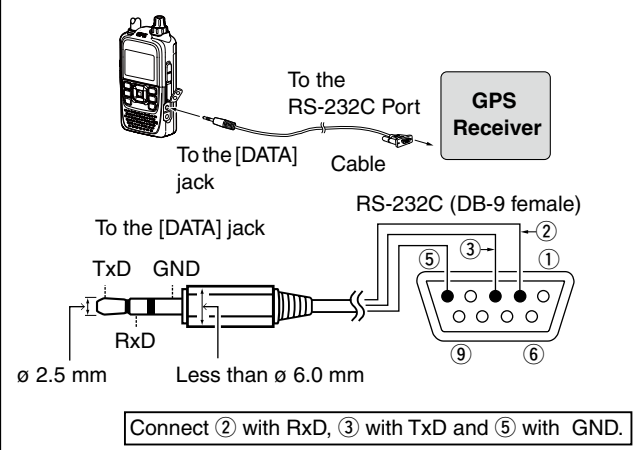

## ■ Checking GPS Position

You can check your current position. The GPS position screen is cancelled when [PTT] is pushed. After releasing, the screen automatically appears. During transmission, the GPS position screen can be selected by pushing [QUICK]<sup>[QUICK]</sup><sub>[SPCH]</sub>.

### ◇ Displaying Position Data

- ① Push [QUICK]<sup>[QUICK]</sup><sub>[SPCH]</sub> to open the Quick Menu screen.
- ② Push D-pad(↑) to select "GPS Position," and then push D-pad(Ent).

The first MY GPS position screen appears. (1/5)

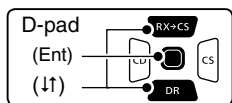

- ③ Push D-pad(↑) to view other position screens.
  - MY Position : Latitude, Longitude, Grid Locator, Altitude, Speed\*, Time and Course\* are displayed. A compass heading is also displayed.
  - RX Position 1: The RX station's position in Latitude, Longitude, Grid Locator, Altitude are displayed. Also, the Distance and Direction from you are displayed.
  - RX Position 2: The SSID, Course, Speed and Time stamp of the RX station is displayed. Depending on the activity of the RX station, some data may not be displayed.
  - MEM Position: The position of the GPS memory location in Latitude, Longitude and Grid Locator are displayed. Also, the Distance and Direction from you to the location is displayed.
  - ALM Position: The position of the GPS memory location for the GPS alarm function in Latitude, Longitude and Grid Locator are displayed. Also, the Distance and Direction from you to the location is displayed.

\*Data entered manually in the "Manual Position" Edit option is not displayed. (p. 16-32)  
(MENU > GPS > GPS Set > **GPS Select**)

- ④ Push [CLR]<sup>[V/MHZ]</sup><sub>[CLR LOW]</sub> to cancel the GPS POSITION screen and return to the operating screen.

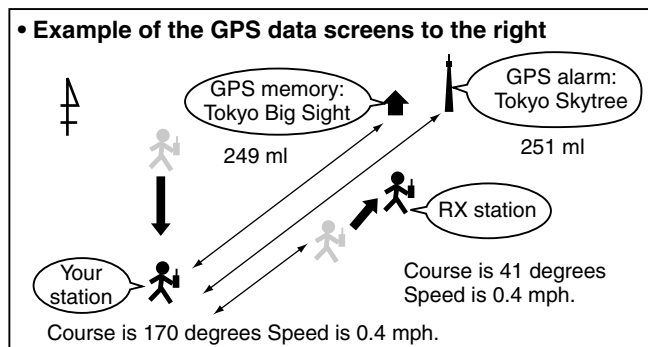

**NOTE:** The latitude, longitude and altitude may differ, depending on your GPS selection of either the internal or an external GPS receiver. Also, the time may not be displayed, depending on the external GPS.

**GPS Information**  
GPS Position  
PRIO Watch

**MY Position**  
GPS POSITION 1/5  
Compass direction Top is North  
Your course heading is north-east  
Your course heading is 170 degrees  
34° 37.37' N ← Latitude  
135° 34.29' E ← Longitude  
GL:PM74SO ← Grid Locator  
ALT:112ft ← Altitude  
SPEED:0.4mph  
MY TIME:12:00:00

**RX Position 1**  
GPS POSITION 2/5  
The direction of the RX station from you.  
The station is east-northeast of you.  
35° 34' 28" N  
135° 48' 18" E  
GL:PM84SO  
ALT:112ft  
DST:83ml ← The distance from you to the station

**RX Position 2**  
GPS POSITION 3/5  
Shows the SSID if the RX station has entered.  
The course heading of the RX station is 41 degrees from north.  
SSID:--  
COURSE:41°  
SPEED:0.4mph  
(13:11) ← Shows the time the RX station acquires the position.

**MEM Position**  
GPS POSITION 4/5  
The direction from you to the memory location.  
The location is east-northeast of you.  
35° 37.73' N  
139° 47.80' E  
GL:PM95VP  
DST:249ml ← The distance from you to the memory location  
MEM Tokyo Big Sight

**ALM Position**  
GPS POSITION 5/5  
The direction from you to the alarm location.  
The location is east-northeast of you.  
35° 42.59' N  
139° 48.65' E  
GL:PM95VR  
DST:251ml ← The distance from you to the alarm location  
ALM Tokyo Skytree

\*When a name is not assigned to the memory channel, Day and Time are displayed instead of the name.

■ Checking GPS Position (Continued)

◇ Changing the Grid Locator

Grid Locator (GL) is a location compressed into a 6 character code, calculated by the longitude and the latitude.

The locator is simply calculated by dividing the earth surface into squares.

It is used to find the location of a radio station.

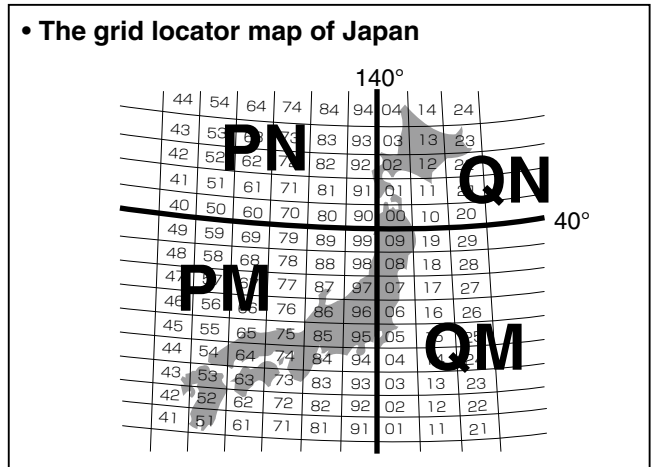
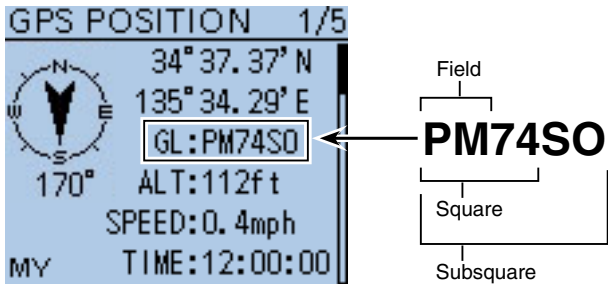

◇ Changing the Compass Direction

You can change the compass direction between Heading Up, North Up and South Up.

- ① While the MY, RX1, MEM or ALM screen is displayed, push [QUICK]<sup>(QUICK)</sup>[SPCH].
- ② Push D-pad(↑) to select “Compass Direction,” and then push D-pad(Ent).

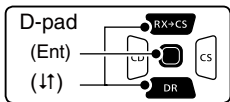

- ③ Push D-pad(↑) to select the compass direction, and then push D-pad(Ent).
  - Heading Up : The compass always pointed to your heading course direction.
  - North Up : The top is always north.
  - South Up : The top is always south.

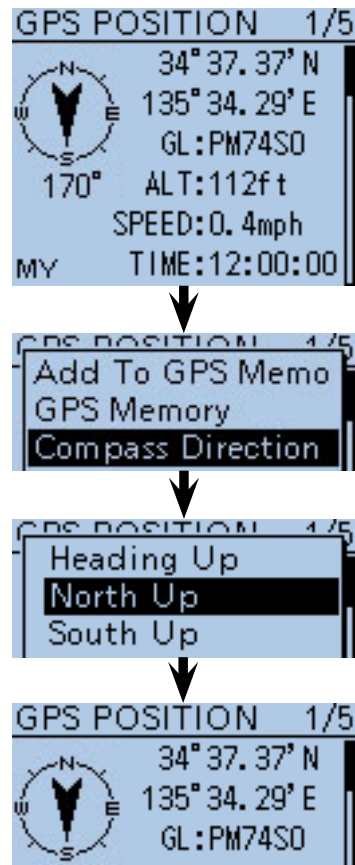
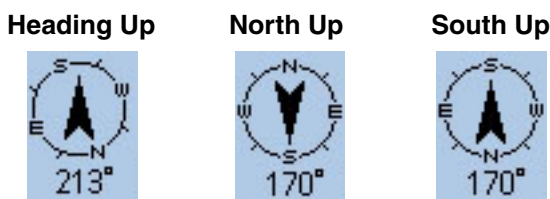

Changing the GPS memory/alarm channel

While displaying the GPS position screen, GPS memory or GPS alarm location can be changed.

- ① While the MEM or ALM screen is displayed, push [QUICK]<sup>(QUICK)</sup>[SPCH].
- ② Push D-pad(↑) to select “GPS Memory Select” or “Alarm Select,” and then push D-pad(Ent).
  - The GPS Memory or Alarm Select screen appears.
- ③ Push D-pad(↑) to select the desired Memory or Alarm location.

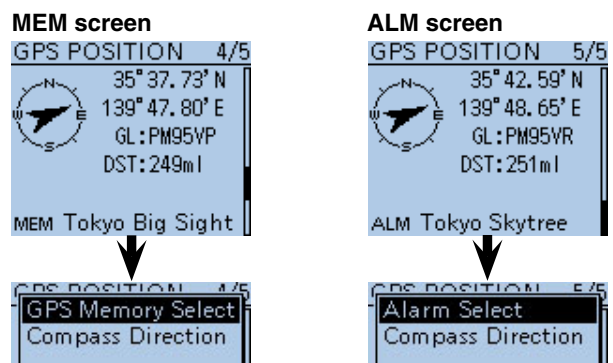



■ Checking GPS Position (Continued)

◇ Saving your own or received position data

With this function, you can save the position information of your station from wherever you are, and also the position information of the station you received it from.

The GPS Memory is capable of storing 200 channels in total, assignable to one of 27 groups, A to Z and “(No Group)”.

- ① Push [QUICK]<sup>QUICK</sup><sub>SPEECH</sub>.
- ② Push D-pad(↑) to select “GPS Position,” and then push D-pad(Ent).

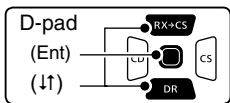

- ③ Push D-pad(↑) to select the position screen that you want to save the contents.
  - To save your position, select the MY position screen.
  - To save the RX station’s position, select the R1 position screen.
- ④ Push [QUICK]<sup>QUICK</sup><sub>SPEECH</sub>.
- ⑤ Push D-pad(↑) to select “Add To GPS Memory,” and push D-pad(Ent).
  - The GPS MEMORY EDIT screen is displayed.
  - The position information (Latitude/Longitude) is automatically added.
  - See pages 10-7 to 10-10 for details on editing position data.
- ⑥ Push D-pad(↑) to select “<<Add Write>>,” then push D-pad(Ent).
  - The confirmation screen “Add Write?” appears.
- ⑦ Push D-pad(↑) to select “Yes,” and then push D-pad(Ent).
  - The added GPS Memory Channel is saved as [00], and the previously saved channel numbers are moved up.
  - The channel is added to GPS Memory and returns to the GPS POSITION screen.
- ⑧ Push [CLR]<sup>V/MHz</sup><sub>CLR LOW</sub> to exit the GPS POSITION screen.

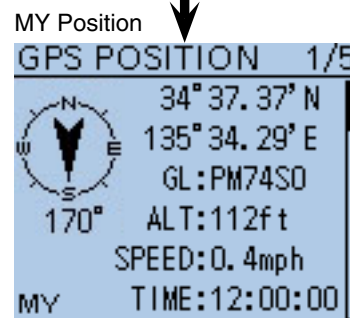
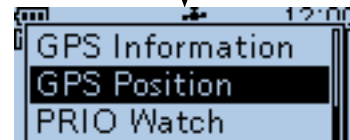
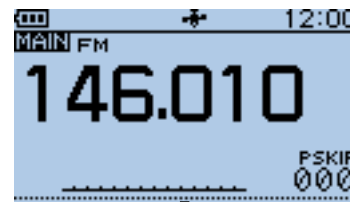

Select the MY position screen to save your position.

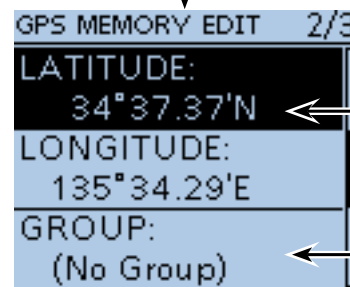
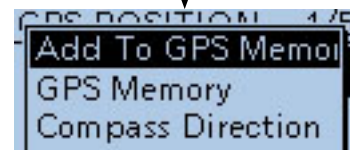

GPS MEMORY EDIT screen is displayed, and Latitude/Longitude is added.

Select the destination group to be saved.

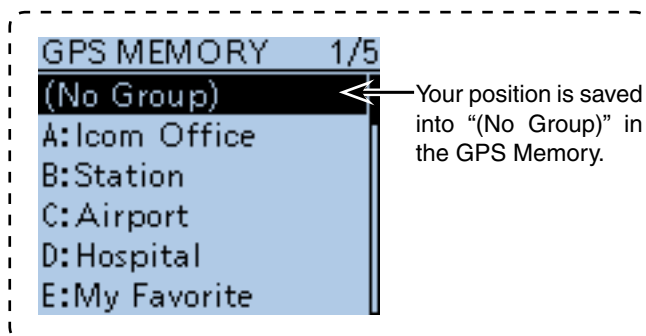
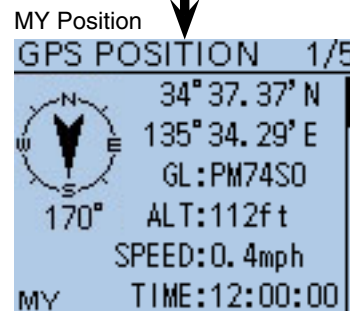
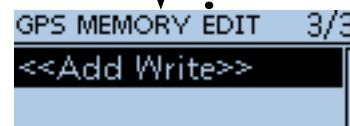

## ■ Checking GPS Information (Sky view screen)

This screen is used to receive GPS satellite when the GPS indicator does not stop blinking for a long time. GPS Information displays the quantity, signal power and position of the GPS satellites.

Sky view screen shows the position of GPS satellites. The screen also shows the direction, elevation angle, satellite numbers and their receiving signal strength status.

- ① Push [QUICK]<sup>[QUICK]</sup>[SPCH].
- ② Push D-pad(↑) to select "GPS Information," and then push D-pad(Ent).

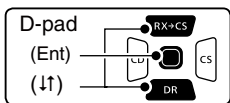

### Meaning of the indications

- (○) : Untracking satellite.
  - (01) : Tracking satellite with a weak signal shown in satellite number.
  - (01) : Tracking satellite with a strong signal shown in satellite number.
  - (SAT) : The quantity of tracking satellites.
  - Altitude : The altitude of your station.  
The altitude is only displayed when more than 4 satellites are tracked. When less than 3 satellites are tracked, [-----ft] is displayed.
  - Longitude/Latitude : Longitude and Latitude of your station.
- ③ Push [QUICK]<sup>[QUICK]</sup>[SPCH] to exit the GPS INFO screen.

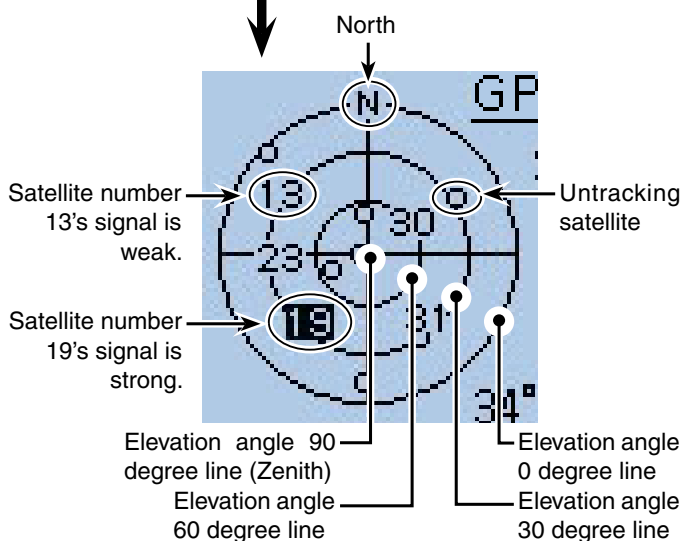
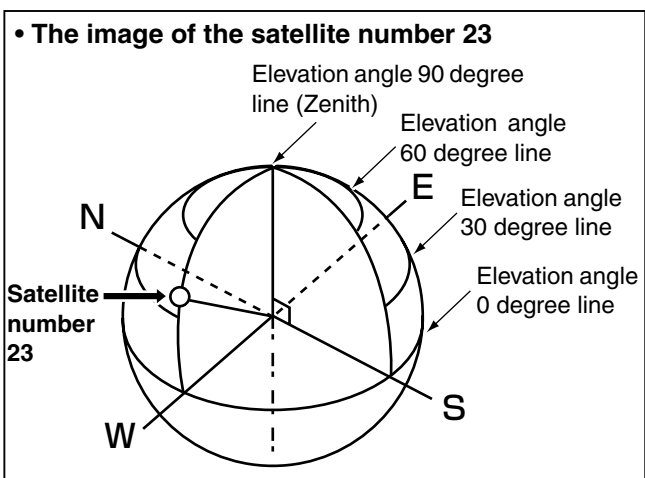
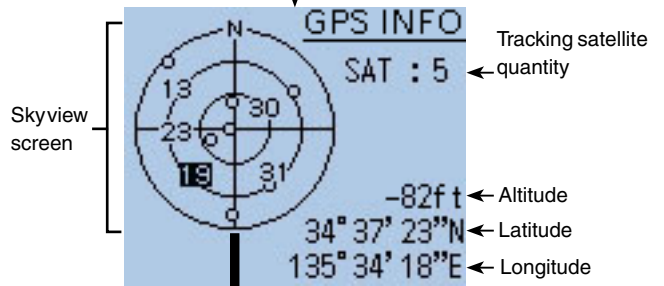
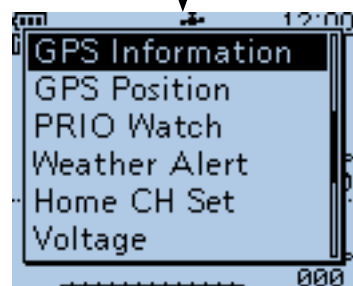
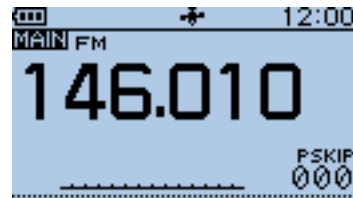



## ■ Adding or editing GPS memory

### ◇ GPS Memory

You can add GPS data to GPS Memory. You can add your own position, other station's position or any positions that are manually programmed. Also, an alarm can be set to GPS Memory to sound, depending on the distance from your station.

The GPS Memory is capable of storing a total of 200 channels in a "ALL" folder, or conveniently stored in up to 27 groups, from A to Z and "(No Group)". The groups can also be named. (p. 16-36)

### ◇ Add a GPS memory

#### 1. Adding GPS Memory and entering the edit mode

- 1 Push [MENU] .
- 2 Push D-pad(↑) to select the root item ("GPS"), and then push D-pad(Ent).

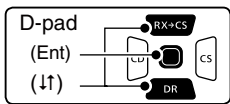

- 3 Push D-pad(↑) to select "GPS Memory," and then push D-pad(Ent).
- 4 Push D-pad(1) to select "(No Group)," and then push D-pad(Ent).
  - All the previously added GPS memories are displayed.
- 5 Push [QUICK] .
- 6 Push D-pad(1) to select "Add," and then push D-pad(Ent).
  - The GPS MEMORY EDIT screen is displayed.

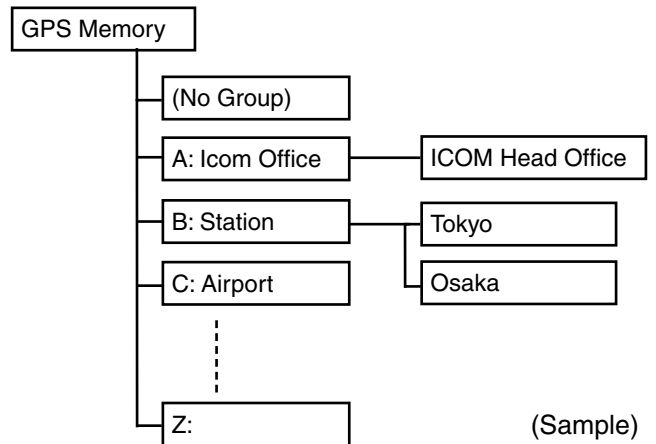

(Sample)

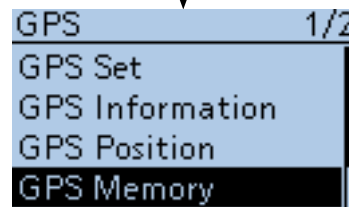

GPS MEMORY screen is displayed.

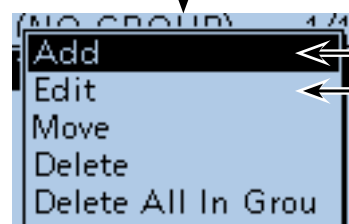

Select "Add"

\*When you want to edit the programmed memory contents, select "Edit."

■ GPS memory operation (Continued)

**2. GPS Memory name programming**

7 Push D-pad(↓) to select "NAME," and then push D-pad(Ent).

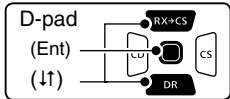

- 8 Rotate [DIAL] to select the first character.
- Selectable input characters are Upper case letters, Lower case letters, Numbers or Symbols.
  - The selected character blinks.
  - Push D-pad(←) to move the cursor backward or forward.
  - While selecting a character, push [QUICK] [SPCH] to change the character to an upper case or lower case letter.
  - While selecting a digit, push [QUICK] [SPCH] to open the input mode selection window.
  - A space can be entered in any input mode selected.
  - Rotate [DIAL] counter clockwise to enter a space.
  - Push [CLR] [V/MHz] [CLR LOW] to delete the selected character, or hold down [CLR] [V/MHz] [CLR LOW] to continuously delete the characters, first to the right, and then to the left of the cursor.
  - See page 2-7 for programming details.
- 9 Push D-pad(→) to move the cursor to the second digit.
- 10 Repeat steps 8 and 9 to enter a GPS Memory name of up to 16 characters, including spaces.
- 11 After entering the name, push D-pad(Ent).

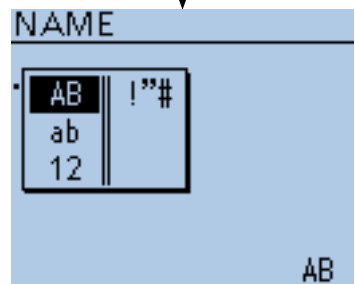
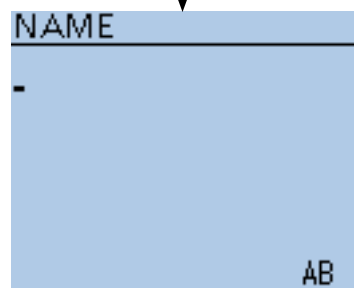
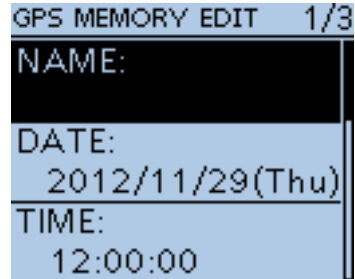

Character type selection screen

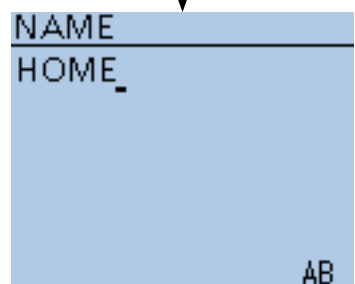

(Example) When entering "HOME"

➤ Continued on the next page

■ GPS memory operation (Continued)

**3. GPS Memory date programming**

- 12 Push D-pad(↓) to select “DATE,” and then push D-pad(Ent).
  - The date edit screen is displayed.

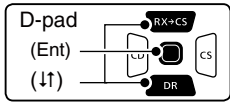

- 13 Rotate [DIAL] to edit the date.
  - The dates between 2000/01/02 to 2099/12/30 are programmable.
- 14 Push D-pad(↔) to move the cursor backward or forward to select and edit the year, month or day.
- 15 Repeat steps 13 and 14 to enter a GPS Memory date.
- 16 After entering the date, push D-pad(Ent).

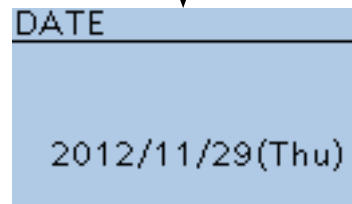
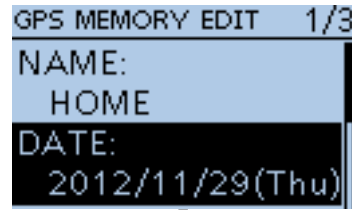

**4. GPS Memory time programming**

- 17 Push D-pad(↓) to select “TIME,” and then push D-pad(Ent).
  - The time edit screen is displayed.
- 18 Rotate [DIAL] to edit the time.
  - The time between 00:00:00 to 23:59:59 are programmable.
- 19 Push D-pad(↔) to move the cursor backward or forward to select and edit the hour, minute or second.
- 20 Repeat steps 18 and 19 to enter GPS Memory time.
- 21 After entering the time, push D-pad(Ent).

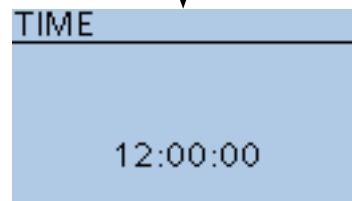

**5. GPS Memory latitude programming**

- 22 Push D-pad(↓) to select “LATITUDE,” and then push D-pad(Ent).
  - The latitude edit screen is displayed.
- 23 Rotate [DIAL] to edit the latitude.
  - The latitude between 0°00.00' to 90°00.00' are programmable.
  - If "ddd°mm'ss'" is selected in the POSITION FORMAT screen, between 0°00'00" to 90°00'00" are programmable.
  - (MENU > GPS > GPS Set > **Position Format**)
- 24 Push D-pad(↔) to move the cursor to backward or forward to select and edit degrees or decimal minutes.
- 25 Repeat steps 23 and 24 to enter a GPS Memory latitude.
  - Select “N” to program the north latitude, and “S” when program the South latitude.
- 26 After entering the latitude, push D-pad(Ent).

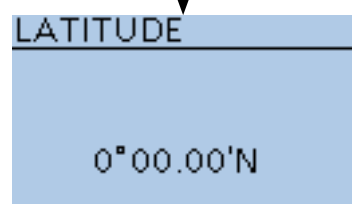
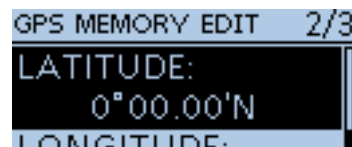

☞ Continued on the next page

■ GPS memory operation (Continued)

**6. GPS Memory longitude programming**

- 27 Push D-pad(↓) to select "LONGITUDE," and then push D-pad(Ent).
  - The longitude edit screen is displayed.

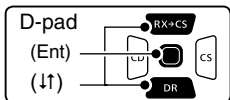

- 28 Rotate [DIAL] to edit the longitude.
  - The longitude between 0°00.00' to 180°00.00' are programmable.
  - If "ddd°mm'ss"" is selected in the POSITION FORMAT screen, between 0°00'00" to 90°00'00" are programmable. (MENU > GPS > GPS Set > **Position Format**)
- 29 Push D-pad(←) to move the cursor to backward or forward to select and edit degrees or decimal minutes.
- 30 Repeat steps 28 and 29 to enter a GPS Memory longitude.
  - Select "E" to program the east longitude, and "W" when program the west longitude.
- 31 After entering the longitude, push D-pad(Ent).

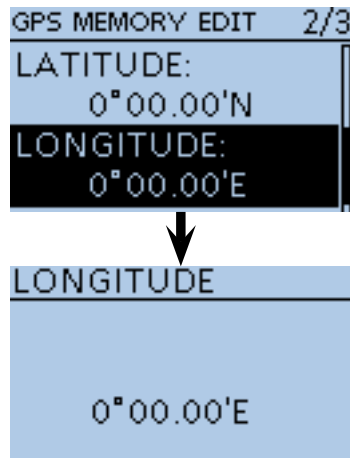

**7. GPS Memory Group programming**

- 32 Push D-pad(↓) to select "GROUP," and then push D-pad(Ent).
  - The group edit screen is displayed.
- 33 Push D-pad(↓) to select a group between A to Z, or select "OFF," and then push D-pad(Ent).
  - Each group is capable of storing up to 200 GPS memories.
- 34 After selecting the memory group, push D-pad(Ent).

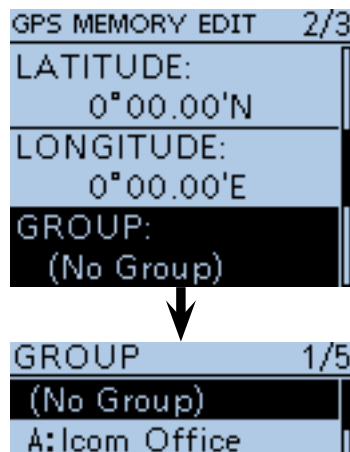

**8. Writing GPS Memory**

- 35 Push D-pad(↓) to select "<<Add Write>>," and then push D-pad(Ent).
  - If a previously added GPS memory is edited, select "<<Overwrite>>."
- 36 Push D-pad(↓) to select "YES," and then push D-pad(Ent).

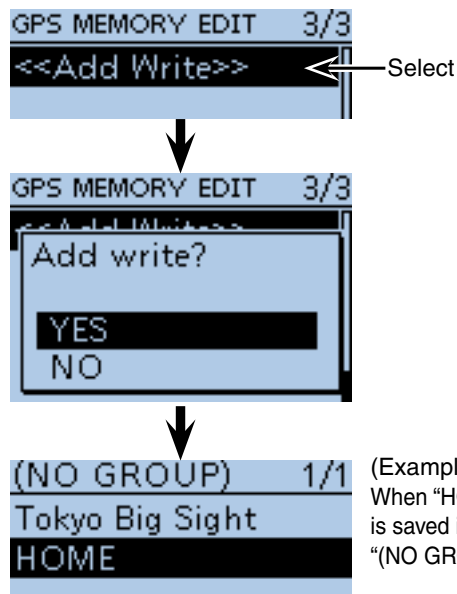

(Example) When "HOME" is saved in "(NO GROUP)".

**To cancel the programmed data:**

- 1 To cancel the programmed data, push [CLR] (V/MHz CLR LOW) to display "Cancel edit?."
- 2 Push D-pad(↓) to select "YES," and then push D-pad(Ent) to cancel programming and return to the GPS Memory's channel list screen.

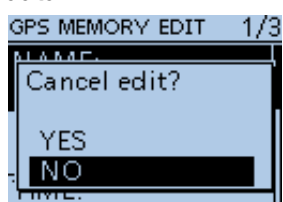





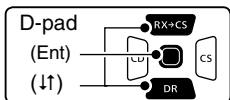

■ GPS memory operation (Continued)

◆ GPS group name programming

You can program the name of each GPS group.

- ① Push [MENU] .
- ② Push D-pad(↓) to select the root item (“GPS”), and then push D-pad(Ent).



- ③ Push D-pad(↓) to select “GPS Memory,” and then push D-pad(Ent).
- ④ Push D-pad(↓) to select the desired group to edit its name.
- ⑤ Push [QUICK] .
- ⑥ Push D-pad(↓) to select “Edit Name,” and then push D-pad(Ent).
- ⑦ The group name editing screen appears.
- ⑧ Rotate [DIAL] to select the first character.
  - Selectable input characters are Upper case letters, Lower case letters, Numbers or Symbols.
  - The selected character blinks.
  - Push D-pad(←) to move the cursor backward or forward.
  - While selecting a character, push [QUICK]  to change the character to an upper case or lower case letter.
  - While selecting a digit, push [QUICK]  to open the input mode selection window.
  - A space can be entered in any input mode selected.
  - Rotate [DIAL] counter clockwise to enter a space.
  - Push [CLR]  to delete the selected character, or hold down [CLR]  to continuously delete the characters, first to the right, and then to the left of the cursor.
  - See page 2-7 for programming details.
- ⑨ Push D-pad(→) to move the cursor to the second digit.
- ⑩ Repeat steps ⑧ and ⑨ to enter a group name of up to 16 characters, including a space.
- ⑪ After entering the name, push D-pad(Ent).

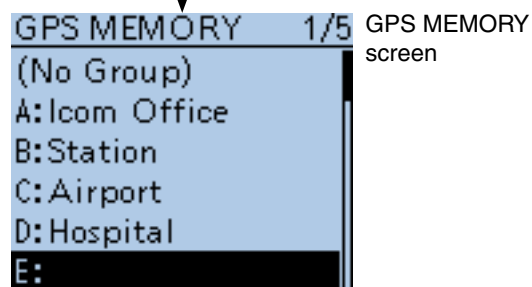
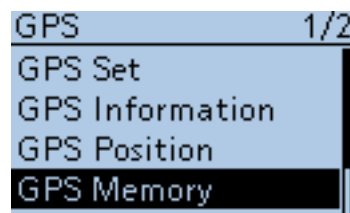

GPS MEMORY screen

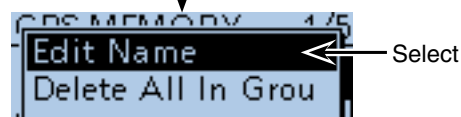

Select

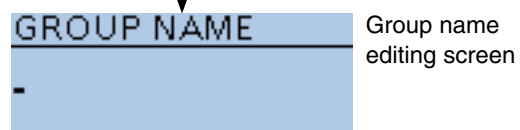

Group name editing screen

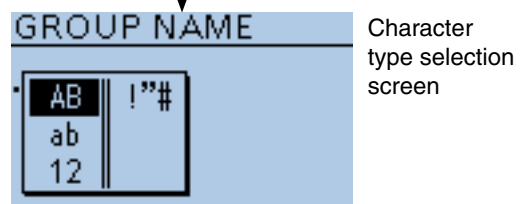

Character type selection screen

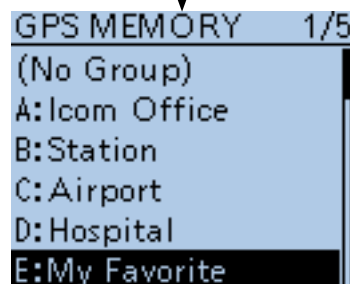
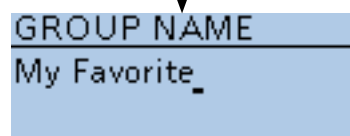

(Example) When group name is programmed as “My Favorite.”

■ GPS memory operation (Continued)

◇ **Deleting GPS data**

All the contents of a GPS memory group can be deleted.

Please note that deleted GPS memories cannot be restored.

- ① Push [MENU] .
- ② Push D-pad(↑) to select the root item ("GPS"), and then push D-pad(Ent).

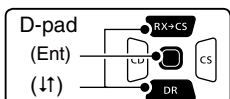

- ③ Push D-pad(↓) to select "GPS Memory," and then push D-pad(Ent).
- ④ Push D-pad(↓) to select the memory group that has the memories you want to delete.  
Example: (No Group)
- ⑤ Push [QUICK] .
- ⑥ Push D-pad(↓) to select "Delete All In Group," and then D-pad(Ent).
- ⑦ Push D-pad(↓) to select "YES," and then push D-pad(Ent).
  - All memories in the group are deleted.

**Example:** Deleting all memories in "(No Group)."

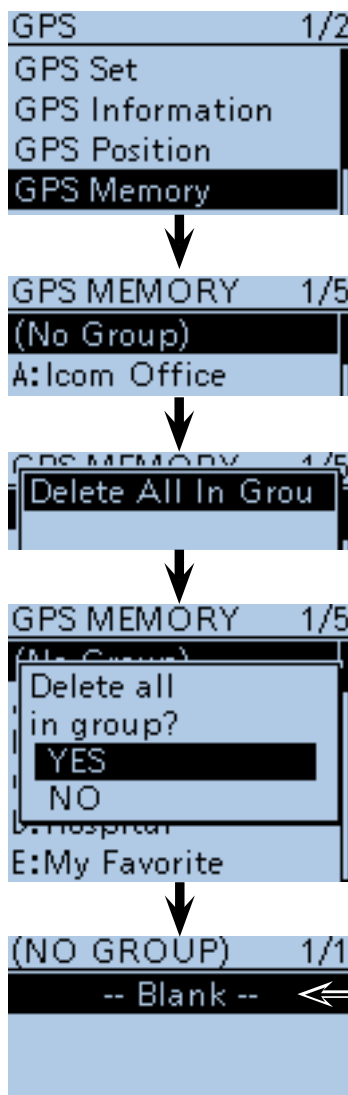

All memories in "(No Group)" are deleted, and "-- Blank --" is displayed if you enter the (NO GROUP) screen.

**To delete a specific GPS memory channel:**

GPS memories can be deleted.

- ① Select a specific memory, as illustrated to the right, and then push [QUICK] .
- ② Push D-pad(↓) to select "Delete," and then push D-pad(Ent).
  - The contents in the selected group are deleted.

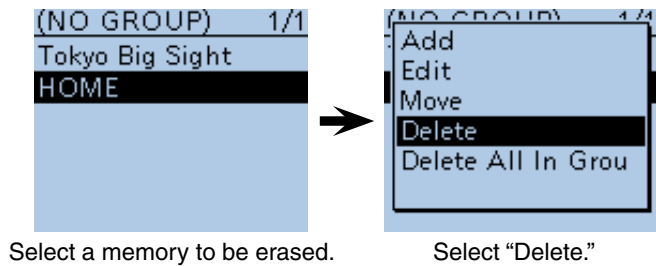

Select a memory to be erased.

Select "Delete."

■ GPS memory operation (Continued)

◇ Rearrange the display order of the GPS memory

You can move programmed GPS memories to rearrange their display order in the selected GPS memory group.

The programmed GPS memory cannot be moved out of their assigned memory group.

- ① Push [MENU] .
- ② Push D-pad(↓) to select the root item ("GPS"), and then push D-pad(Ent).

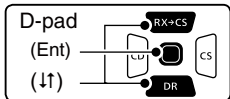

- ③ Push D-pad(↓) to select "GPS Memory," and then push D-pad(Ent).
- ④ Push D-pad(↓) to select the GPS memory group that has the GPS memory you want to move, and then push D-pad(Ent).
- ⑤ Push D-pad(↓) to select the GPS memory to be moved.
- ⑥ Push [QUICK] .
- ⑦ Push D-pad(↓) to select "Move," and then push D-pad(Ent).
  - "DESTINATION" blinks on the upper left of the LCD.
- ⑧ Push D-pad(↓) to select the location to insert the memory you want to move, which will be above the memory name selected in this screen, and then push D-pad(Ent).
  - The selected memory contents are inserted to above the destination memory name.
  - When "<<Move End>>" is selected, the selected memory contents are moved to the bottom of the GPS memory group.

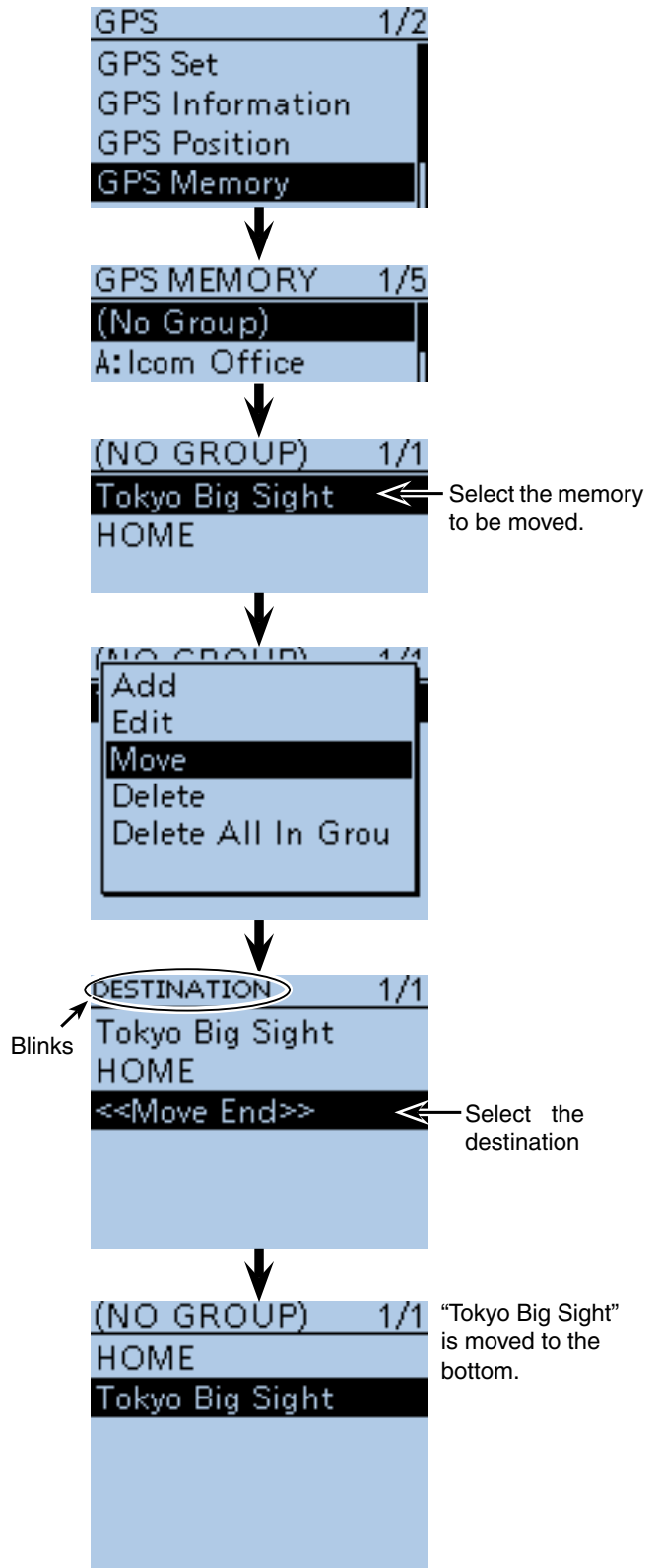

■ GPS memory operation (Continued)

◆ GPS alarm setting

A GPS alarm can sound when a target position comes into the alarm area.

This function can be set to the caller station, all GPS Memory channels, a specified Memory group or a specified Memory channel.

- **Alarm area (Group)** — Setting plural stations  
When all channels or group is selected:

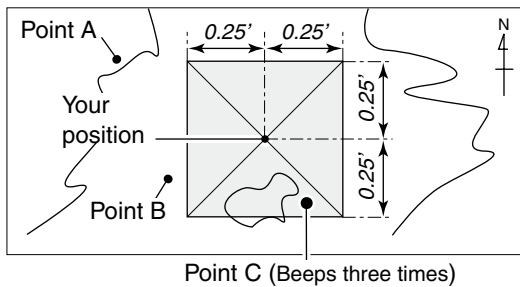

- 1 Push [MENU] .
- 2 Push D-pad(↑) to select the root item (“GPS”), and then push D-pad(Ent).

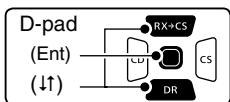

- 3 Push D-pad(↓) to select “GPS Alarm,” and then push D-pad(Ent).
- 4 Push D-pad(←) to select “Alarm Select,” and then push D-pad(Ent).
- 5 Push D-pad(↑) to select “Group,” and then push D-pad(Ent).
- 6 Push D-pad(←) to select “All Memories,” and then push D-pad(Ent).
  - If you wish to set the alarm to a GPS Memory group, select one between A to Z or “(No Group).”
- 7 Push [MENU] to exit the Menu screen.
  - When either one of the stations in a specified group enters its set range, the beep sounds three times.
  - When the GPS alarm beeps, “GPS ALARM” pops up on the screen and then the (••) icon blinks.
  - To cancel the GPS alarm, repeat step 5 and select “OFF.”

NOTE: When “Group” is selected in step 5, and a target position enters in the active alarm range specified in “Alarm area (Group)” of the Menu screen, the GPS alarm sounds. (p. 16-37)  
(MENU > GPS > GPS Set > **Alarm Area (Group)**)

• GPS Alarm beeping screen

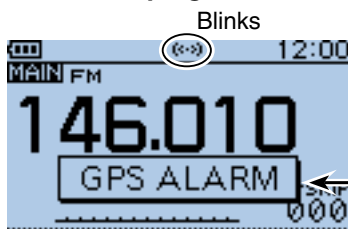

The pop up is displayed and beeps 3 times.

- **Alarm area (RX/Memory)**— Setting specific stations  
When a specified memory is selected:

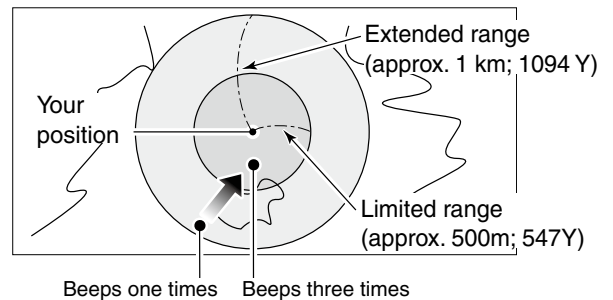

Example: Alarm Area (Group)

Alarm Setting is set to all GPS Memories.

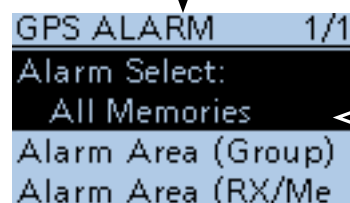
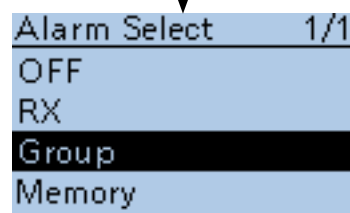
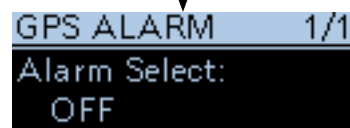
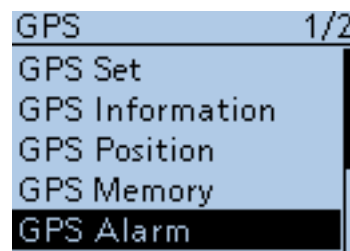

“All Memories” is displayed.



■ GPS memory operation

◇ GPS alarm setting (Continued)

- ① Push [MENU] .
- ② Push D-pad(↑) to select the root item ("GPS"), and then push D-pad(Ent).

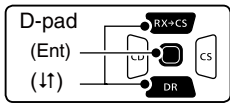

- ③ Push D-pad(↑) to select "GPS Alarm," and then push D-pad(Ent).
- ④ Push D-pad(↑) to select "Alarm Select," and then push D-pad(Ent).
- ⑤ Push D-pad(↑) to select "RX," and then push D-pad(Ent).
  - If you want to set the alarm to a specified GPS memory channel, select "Memory," then push D-pad(Ent). And then, select the channel in the GPS memory group.
- ⑥ Push [MENU]  to exit the Menu screen.
  - When a set station is in the approximate 1 kilometer range, GPS Alarm beeps once, and when it is in the approximate 500 meter range, beeps three times. (Default: Both)
  - When the GPS alarm beeps, "GPS ALARM" pops up on the screen and then the ((•)) icon blinks.
  - To cancel the GPS alarm, repeat step ⑤ and select "OFF."

**NOTE:** When "RX" or a GPS memory channel is selected in step ⑤, the GPS alarm sounds depend on the "Alarm Area (RX/Memory)" setting in the Menu screen. (p. 16-38)  
 (MENU > GPS > GPS Set > **Alarm Area (RX/Memory)**)

**NOTE:** Even if "RX" is selected in step ⑤, and the received signal has no position, the GPS alarm does not sound.

**Example:** Alarm Area (RX/Memory)  
 Alarm Setting is set to RX.

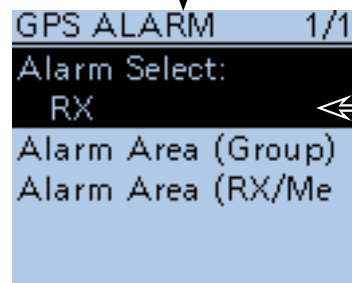
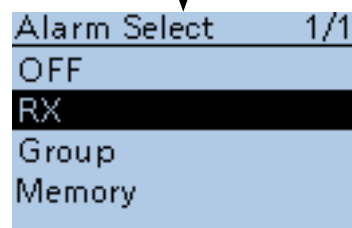
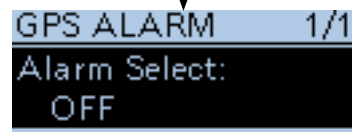
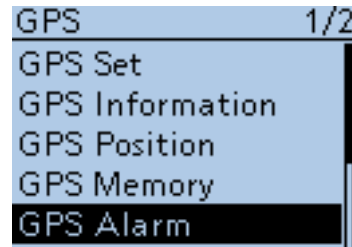

← "RX" is displayed.

• GPS Alarm beeping screen

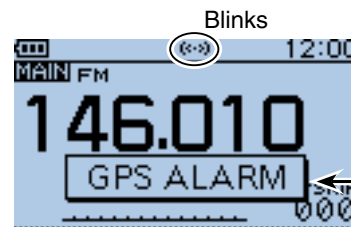

← The pop up is displayed and beeps sound, depending on the setting of the alarm area.



## ■ Transmitting GPS data

Set a GPS sentence to transmit GPS data in DV mode.

### ◇ GPS data sentence setting

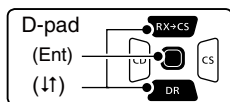
- ① Push [MENU]  and select "GPS."
- ② Push D-pad(↑) and D-pad(Ent) to select "GPS TX Mode."



- ③ Push D-pad(↑) to select "GPS(DV-G)," and then push D-pad(Ent).
- ④ Push D-pad(↑) to select "GPS Sentence" and then push D-pad(Ent).
  - The GPS Sentence screen is displayed.
- ⑤ Push D-pad(↑) to select the desired GPS sentence, and then push D-pad(Ent) to turn it ON or OFF.
  - The selectable GPS sentences are RMC, GGA, GLL, VTG, GSA and GSV. The GGA sentence is only set to ON as default GPS sentence.
  - Push [QUICK] , then push D-pad(Ent) to set the sentence as the default.
- ⑥ Repeat step ⑤ to set other GPS sentences.
  - A maximum of 4 GPS sentences can be set at a time.
- ⑦ Push [MENU]  to exit the Menu screen.

#### NOTE:

- Set the GSV sentence to OFF when sending the GPS message to conventional digital transceivers (IC-2820H, IC-E2820, ID-800H, IC-91AD, IC-E91, IC-V82, IC-U82, IC-2200H, ID-1). The GSV sentence is incompatible with them. Those transceivers will not display GPS messages properly if a GSV sentence is sent from the ID-51A/E.
- If "GPS select" is set to "Manual," the GPS sentence is artificially selected and transmitted, according to the manually set position in "Manual Position." (p. 16-32)  
(MENU > GPS > GPS Set > **Manual Position**)
- If "GPS Auto TX" is set to any other setting than "OFF," the current position data is transmitted at the specified interval. (p. 10-24)  
(MENU > GPS > **GPS Auto TX**)

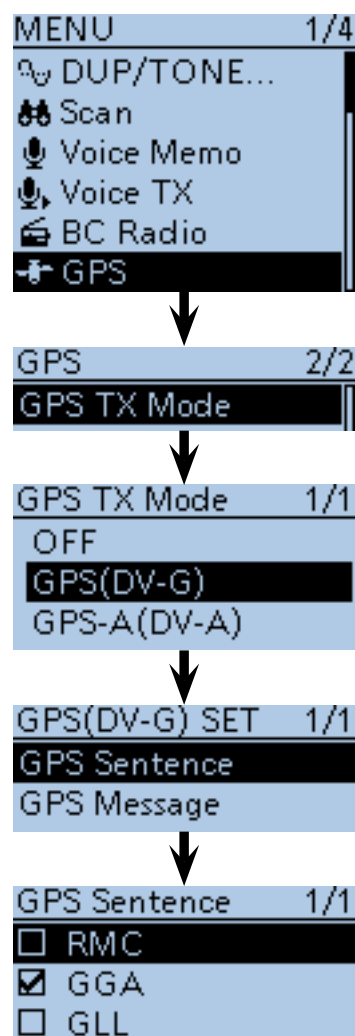

#### • The display while transmitting GPS (DV-G)

"DV-G" appears if "GPS (DV-G)" is selected in DV Mode.

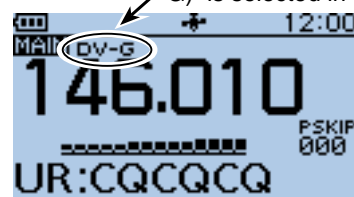

When transmitted, the set GPS sentence is transmitted.

#### • Contents of GPS sentence

Sentence	Lat/ Lon	Alt	GPS Time Stamp (UTC)	Date (UTC)	Status	2D /3D	COG (True)	SOG (knot)	Others
RMC	✓		✓	✓	✓				Mode Indicator
GGA	✓	✓	✓		✓				Number of satellites in use, HDOP, Geoidal separation, Age of Differential GPS data
GLL	✓		✓		✓				Mode Indicator
VTG							✓	✓	COG (Magnetic north), SOG (km/h), Mode Indicator
GSA					✓	✓			ID numbers of satellites used in solution, PDOP, HDOP, VDOP
GSV									Total number of sentences, Sentence number, Total number of satellites in view, Satellite information (ID, Altitude, Azimuth, S/N)

■ Transmitting GPS data (Continued)





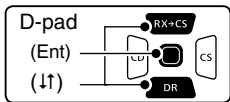

◇ GPS message programming

Enter a GPS message of up to 20 characters to be transmitted with the position data.

- ① Push [MENU] .
- ② Push D-pad(↑) to select the root item ("GPS"), and then push D-pad(Ent) to go to the next screen.



(MENU > GPS > GPS TX Mode > GPS(DV-G) SET > **GPS Message**)

- ③ Refer to the menu sequence shown directly above, and push D-pad(↑) to select, and then D-pad(Ent) to enter, one or more times until the last screen is displayed.
- ④ Push [QUICK] .
- ⑤ Push D-pad(↑) to select "Edit," and then push D-pad(Ent).
- ⑥ The message editing screen appears.
- ⑦ Rotate [DIAL] to select the first character.  
(Example: O)
  - Selectable input characters are Upper case letters, Lower case letters, Numbers or Symbols.
  - The selected character blinks.
  - Push D-pad(←) to move the cursor backward or forward.
  - While selecting a character, push [QUICK]  to change the character to an upper case or lower case letter.
  - While selecting a digit, push [QUICK]  to open the input mode selection window.
  - A space can be entered in any input mode selected.
  - Rotate [DIAL] counter clockwise to enter a space.
  - Push [CLR]  to delete the selected character, or hold down [CLR]  to continuously delete the characters, first to the right, and then to the left of the cursor.
  - See page 2-7 for programming details.
- ⑧ Push D-pad(→) to move the cursor to the second digit.
- ⑨ Repeat steps ⑦ and ⑧ to enter a group name of up to 20 characters, including spaces.
- ⑩ After entering, push D-pad(Ent).
- ⑪ Push [MENU]  to exit the Menu screen.

Example: Adding "OSAKA suzuki"

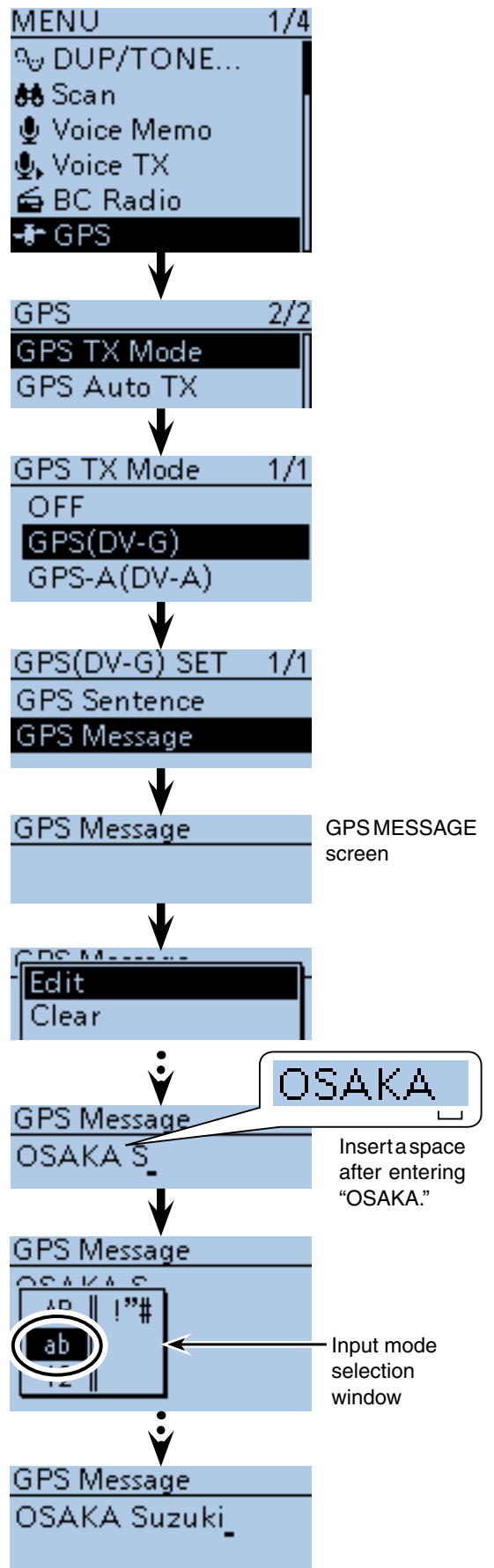

## ■ Transmitting GPS-A data

GPS-A mode is an operating mode supported with the D-PRS to transmit position data.

In GPS-A operation, the following codes are transmitted to the PC connected to the ID-51A/E.

GPS-A code is based on **APRS**® code.

(APRS®: Automatic Position Reporting System).

### About GPS-A data

GPS-A data is formatted as shown below.

(e.g.) JA3YUA>API51,DSTAR\*/002338h3437.38N/13534.29E>000/000/A=000000Who are you?  
 ①                      ②                      ③                      ④                      ⑤                      ⑥                      ⑦                      ⑧

- |                      |               |                      |                          |
|----------------------|---------------|----------------------|--------------------------|
| ① Your own call sign | ③ Time stamp* | ⑤ GPS-A symbol (Car) | ⑦ Data extension         |
| ② Unproto address    | ④ Latitude    | ⑥ Longitude          | ⑧ GPS-A comment/Altitude |

\*h: "hhmmss", z: "ddhhmm"

- The **UTC** time is used.
- The data from the internal or external GPS is used.

### ◇ D-PRS

D-PRS is a function which simultaneously sends position data received from the internal or external GPS receiver, using the slow speed data packet space, along with voice in the DV mode.

In the analog format you can transmit or receive only voice or data at one time. However a D-PRS capable radio can transmit or receive message data or GPS position data at the same time voice is been transmitted or received.

#### • The image of D-PRS

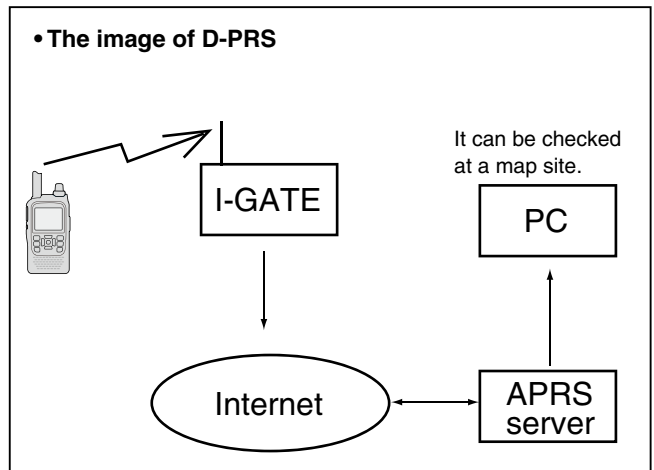

### ◇ Operating GPS-A

To transmit in GPS-A, follow the steps written below, and for more details, see the pages listed along with the steps.

1. "MY"(Your own call sign) programming (p. 16-54)
2. Receiving GPS data (p. 10-2)
3. Set GPS TX Mode to GPS-A (p. 10-16)
4. Transmitting GPS-A data setting (pp. 10-19 to 10-22)



**Setting is completed.**  
**(Transmission is enabled in GPS-A)**

#### NOTE:

- If "Manual" is selected in the GPS select screen, the processed GPS-A code is transmitted, according to the manually set position data in "Manual Position." (p. 16-32)  
 (MENU > GPS > GPS Set > **Manual Position**)
- Please note that if "GPS Auto TX" is set as any other setting than "OFF," the data is transmitted each and every setting time. (p. 16-47)  
 (MENU > GPS > **GPS Auto TX**)

■ Transmitting GPS-A data (Continued)

◇ **Setting GPS-A**

Set to transmit in the GPS-A mode.

**1. Setting GPS-A in the GPS TX Mode**

- ① Push [MENU] .
- ② Push D-pad(↑) to select the root item ("GPS"), and then push D-pad(Ent) to go to the next screen.

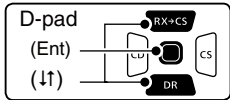

(MENU > GPS > GPS TX Mode > **GPS-A(DV-A)**)

- ③ Refer to the menu sequence shown directly above, and push D-pad(↑) to select, and then D-pad(Ent) to enter, one or more times until the last screen is displayed.

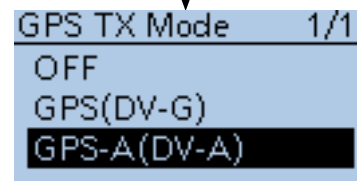
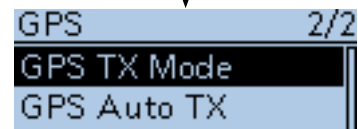
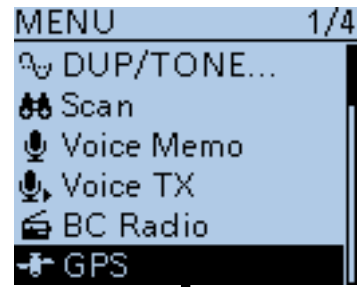

**2. Unproto Address display**

The default address should be used, and editing is not recommended.

- ④ Push D-pad(↓) to select "Unproto Address," and then push D-pad(Ent).
  - The default setting is "API51,DSTAR\*."
- ⑤ Push D-pad(Ent) to return to the previous screen.

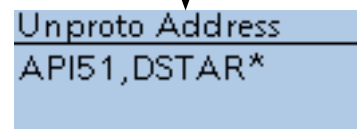
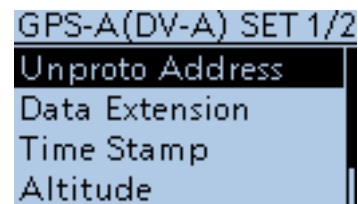

**3. Setting Data Extension**

Set the data extension of your station's course direction and speed.

- ⑥ Push D-pad(↓) to select "Data Extension," and then push D-pad(Ent).
- ⑦ Push D-pad(↓) to select "Course/Speed," and then push D-pad(Ent).

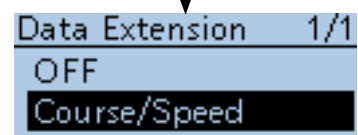
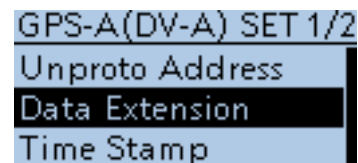

☞ Continued on the next page

■ Transmitting GPS-A data (Continued)

**4. Setting Time Stamp**

Set the time stamp function to transmit the received time in **UTC** (Universal Time Coordinated) time.

- 8 Push D-pad(↓) to select "Time Stamp," and then push D-pad(Ent).

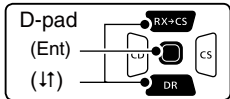

- 9 Push D-pad(↓) to select either the DHM or HMS format, and then push D-pad(Ent).
  - OFF : Does not transmit the time.
  - DHM : Transmits the time stamp in the Day, Hour, and Minute format.
  - HMS : Transmits the time stamp in the Hour, Minute, and Second format.

**5. Setting Altitude**

Set the altitude transmission.

- 10 Push D-pad(↓) to select "Altitude," and then push D-pad(Ent)
- 11 Push D-pad(↓) to select "ON," and then push D-pad(Ent).

**NOTE:**  
 If you transmit with the altitude setting ON, to those products that are not capable of displaying the altitude (IC-9100, IC-80AD, IC-E80D, ID-880H, ID-E880, IC-92AD, IC-E92D), the characters appear as a comment.

**6. Setting GPS-A Symbol**

Select the desired GPS-A symbol which represents your operating situation. The selected GPS-A symbol channel's symbols (1~4) are transmitted along with the position data.

- 12 Push D-pad(↓) to select "GPS-A Symbol," and then push D-pad(Ent).
- 13 Push D-pad(↓) to select a symbol between 1: Person, 2: Bicycle, 3: Car and 4: House, and then push D-pad(Ent).
  - If you wish to use any GPS-A symbol (characters) or previously saved symbol, see page 16-44 for details.

Push [QUICK] <sup>QUICK</sup> <sub>SPCH</sub> to display the "Edit Symbol" screen.

A screenshot of the 'Edit Symbol' screen. The screen title is 'Edit Symbol'. Below the title, there is a list of symbols with their corresponding icons and keyboard shortcuts: '1: Person' with a person icon and '[ /t ]', '2: Bicycle' with a bicycle icon and '[ /b ]', and '3: Car' with a car icon and '[ /> ]'. The '1: Person' option is currently selected.

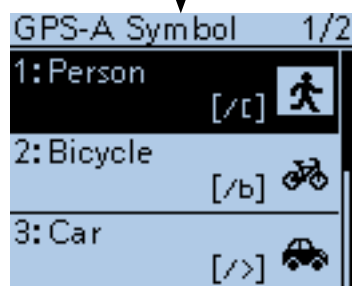
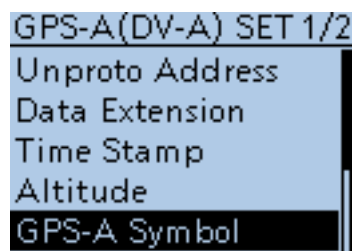
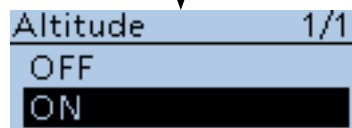
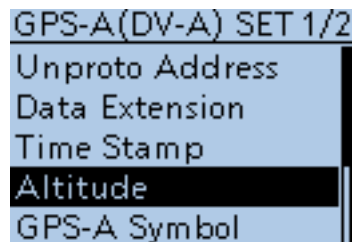
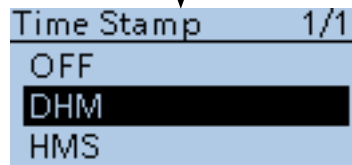
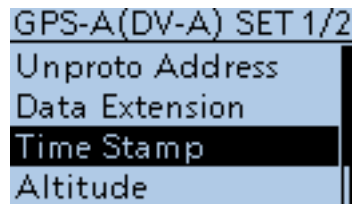

☞ Continued on the next page

■ Transmitting GPS-A data (Continued)

7. Setting SSID

To assist in identifying a station's type, the displayed APRS® based SSID is added after the GPS-A data call sign.

The SSID's adding method differs, depending on whether if you enter a space in your call signs or not.

14 Push D-pad(↓↑) to select "SSID," and then push D-pad(Ent).

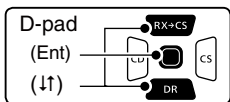

15 Push D-pad(↓↑) to select SSID, and then push D-pad(Ent).

- --- : Change the space in call sign to "-".  
If the space is the last character, delete the space instead of changing it to a "-".  
Example: JA3YUA A → JA3YUA-A
- (-0) : No SSID. If you use a capital letter, it will be deleted.  
Example: JA3YUA A → JA3YUA
- -1 to -15 : Adds an SSID of -1 to -15 to your call sign.  
Example: "-9" is entered  
JA3YUA A → JA3YUA-9
- -A to -Z : Adds an SSID of -A to -Z to your call sign.  
Example: "-Z" is entered  
JA3YUA A → JA3YUA-Z

16 After setting SSID, push D-pad(Ent).

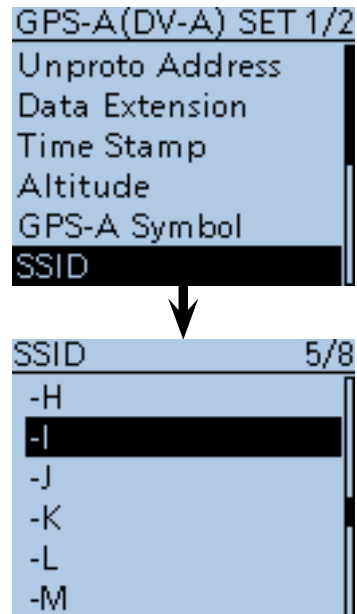

☞ Continued on the next page

**About SSID**  
 To assist in identifying a station's type, designated call sign SSIDs are used in D-PRS (APRS®), according to the common guideline.  
 The guideline may be changed when the infrastructure environment, such as a product or network, is changed.  
 Please check the latest guideline in the web site related on the D-PRS or APRS®, and correctly set.

■ Transmitting GPS-A data (Continued)

**8. Comment programming**

Program your comment and transmit it with the GPS-A position data.

The number of characters you can enter differs, depending on the settings of data extension (p. 10-19) and altitude (p. 10-20).

Data Extension	Altitude	The number of characters
OFF	OFF	less than 43 (Default)
OFF	ON	less than 35
Course/Speed	OFF	less than 36
Course/Speed	ON	less than 28

17 Push D-pad(↓) and D-pad(Ent) to select “Comment.”

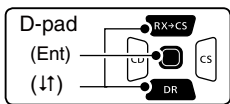

18 Push [QUICK] [QUICK/SPCH].

19 Push D-pad(↓) to select “Edit,” then push D-pad(Ent), and then the comment editing screen appears.

20 Rotate [DIAL] to select the first character.

- Selectable input characters are Upper case letters, Lower case letters, Numbers or Symbols.
- The selected character blinks.
- Push D-pad(←) to move the cursor backward or forward.
- While selecting a character, push [QUICK] [QUICK/SPCH] to change the character to an upper case or lower case letter.
- While selecting a digit, push [QUICK] [QUICK/SPCH] to open the input mode selection window.
- A space can be entered in any input mode selected.
- Rotate [DIAL] counter clockwise to enter a space.
- Push [CLR] [V/MHz/CLR LOW] to delete the selected character, or hold down [CLR] [V/MHz/CLR LOW] to continuously delete the characters, first to the right, and then to the left of the cursor.
- See page 2-7 for programming details.
- A character after “J” would not be transmitted.

21 After entering the comment, push D-pad(Ent).

22 Push [MENU] [MENU/PO] to exit the Menu screen.

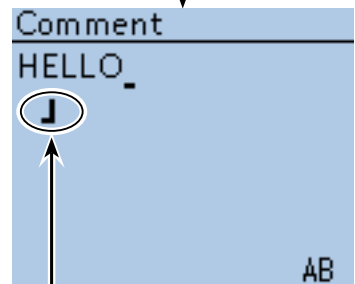
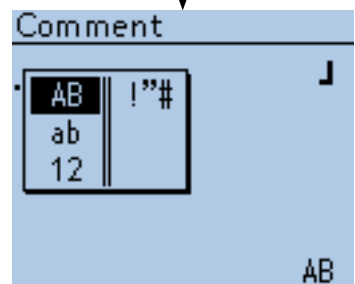
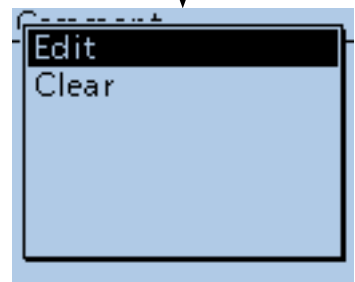
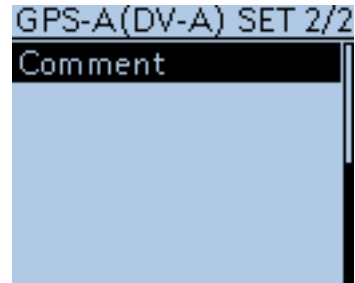

Ending icon (Up to 28 characters can be input)



### ■ Transmitting GPS-A data (Continued)

#### ◇ **Displaying your position using a mapping software**

If you transmit to an I-GATE station, then enter the call sign information on the internet map website, the set GPS-A symbol is displayed.



## ■ GPS Auto transmission for only Simplex

In the DV mode, this function automatically transmits the GPS receiver's current position data, at a selected interval, and should only be used in **Simplex** transmission.

**NOTE:**

- Your own call sign must be entered to activate the GPS automatic transmission.
- When the "GPS Select" item on page 16-32 is set to "OFF" or "Manual," this function is disabled.  
(MENU > GPS > GPS Set > **GPS Select**)

◇ **Setting the GPS automatic transmission**

- ① Push [MENU]  to enter the Menu screen.
- ② Push D-pad(Ent) to select the root item ("GPS"), and then push D-pad(Ent).

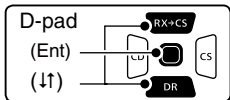

- ③ Push D-pad(Left) to select "GPS Auto TX," and then push D-pad(Ent).
- ④ Rotate [DIAL] to select a desired position data transmit interval.
  - Selectable settings are OFF, 5\*, 10, 30 seconds and 1, 3, 5, 10 and 30 minutes.
  - \* If four GPS sentences are selected in GPS SENTENCE menu on page 16-41, "5sec" cannot be selected.
  - Selecting "OFF" cancels the GPS automatic transmission.
  - The GPS message is also transmitted, if programmed.
- ⑤ Push [MENU]  to exit the Menu screen.

**NOTE:**

- Use GPS automatic transmission in only the simplex mode.
- GPS automatic transmission through a **repeater** may interfere with other communications. When a GPS message is programmed, the transceiver transmits it along with the position data. See page 16-42 for the GPS message programming.

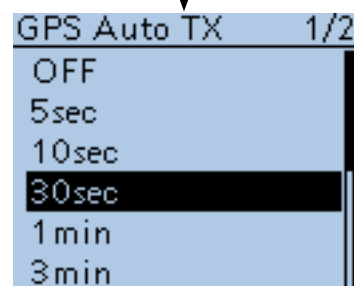
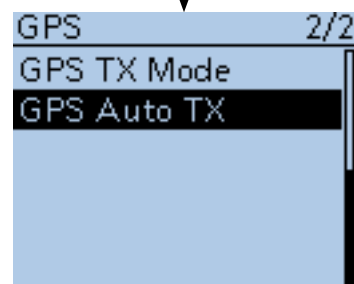
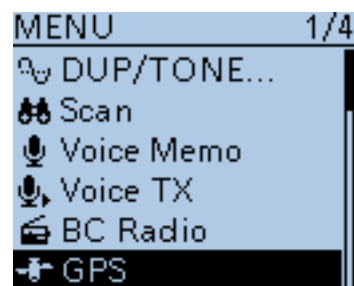

## ■ GPS Logger function

The GPS Logger function allows you to store the positions from a GPS receiver, into a microSD card, as your route.

The GPS Logger stores Latitude, Longitude, Altitude, Positioning state, Course, Speed and Date.

If you use this GPS Logger while driving, you can check your driving course on a mapping software.

### ◇ GPS Logger operating outline

To use GPS Logger function, perform following operations.

1. Insert a microSD card.  
(microSD cards are not available from Icom. Purchase a card to meet your needs.)
2. Turn ON the GPS receiver.
3. Turn ON the GPS Logger function.



The logger function starts.

### ◇ GPS Logger operation

- ① Push [MENU] .
- ② Push D-pad(↑) to select the root item ("GPS"), and then push D-pad(Ent) to go to the next screen.

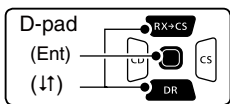

(MENU > GPS > GPS Set > **GPS Select**)

- ③ Refer to the menu sequence shown directly above, and push D-pad(↑) to select, and then D-pad(Ent) to enter, one or more times until the last screen is displayed.
- ④ Push D-pad(↑) to select "Internal GPS."
  - If an external GPS receiver is connected, select "External GPS."
- ⑤ Push [MENU]  to exit the Menu screen.
  - The GPS icon blinks when receiving data, as illustrated below, and stops blinking when valid data is received. If "Manual" was selected, the icon does not appear.

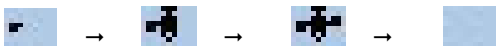

- It may take longer or shorter time to receive, depending on the environment. If you find difficulties receiving, we recommend that you change to a better location.

#### NOTE:

When the "GPS Select" item is set to "Internal GPS," the battery pack or batteries may become exhausted soon, due to the internal GPS receiver working all the time. To minimize this, use the "Power Save (Internal GPS)" function in GPS Menu.

(MENU > GPS > GPS Set > **Power Save (Internal GPS)**)

#### NOTE:

- The GPS logger function requires inserting a microSD card.
- Once the GPS logger function is turned ON, the transceiver continuously stores the position data from the GPS receiver, even if the transceiver is rebooted. To cancel this function, turn the function OFF.

During this function is ON, and when the transceiver is turned OFF, the log file will be closed. Then the transceiver is turned ON and Positioning is carried out by the GPS receiver, a new log file will be created.

- When a free space of the microSD card is lost, this function will be automatically paused.

The transceiver has an exclusive GPS logger mode where only the logger is functioning. For example, when you are traveling and don't want to use the transceiver for communication, but you do want to use just a GPS logger, this mode is useful. See page 10-29 for details.

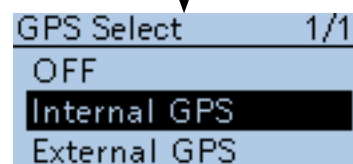
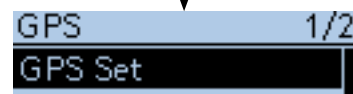
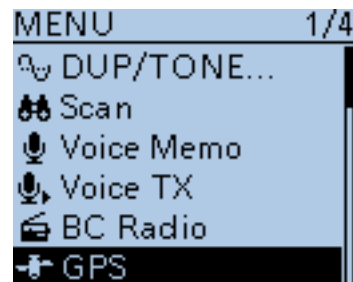

GPS SELECT screen

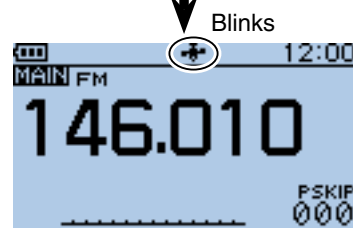

■ GPS Logger function (Continued)

◇ **Turning ON the GPS Logger function**

Turn the GPS logger function ON or OFF, to store your route as you move.

When the GPS Logger function is set to ON, the transceiver stores the position data from GPS receiver into microSD card in a specified time interval.

While using the Internal GPS receiver only four GPS sentences, GGA, RMC, GSA and VTG, are used.

- ① Push [MENU] .
- ② Push D-pad(↓) to select the root item (“GPS”), and then push D-pad(Ent) to go to the next screen.

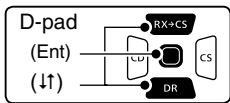

(MENU > GPS > GPS Logger > **GPS Logger**)

- ③ Refer to the menu sequence shown directly above, and push D-pad(↓) to select, and then D-pad(Ent) to enter, one or more times until the last screen is displayed.
- ④ Push D-pad(↓) to select “ON.”
- ⑤ Push [MENU]  to exit the Menu screen.
  - The GPS Logger starts.

/// **NOTE:**

While using the external GPS receiver, uses only the compatible GGA, RMC, GSA and VTG sentences.

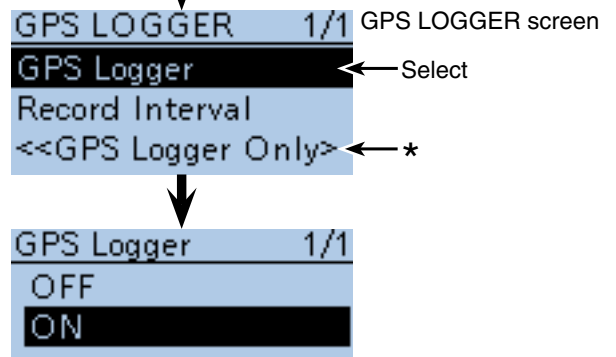
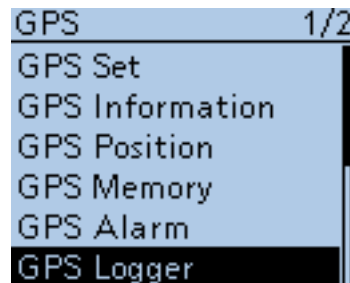

\* The transceiver has an exclusive GPS logger mode where only the logger is functioning. See page 10-29 for details.

◇ **Setting the GPS record interval**

For example, when you are walking and if the time interval is set to “1sec,” a lot of position data is stored at almost same place. Select the GPS Logger function record interval to suit your travel speed. (Default: 5sec)

- ① Push [MENU] .
- ② Push D-pad(↓) to select the root item (“GPS”), and then push D-pad(Ent) to go to the next screen.

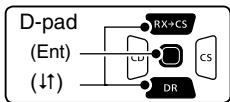

(MENU > GPS > GPS Logger > **Record Interval**)

- ③ Refer to the menu sequence shown directly above and push D-pad(↓) to select, and then D-pad(Ent) to enter, one or more times until the last screen is displayed.
- ④ Push D-pad(↓) to select a desired record interval.
  - Selectable settings are 1, 5, 10, 30 or 60 seconds.
- ⑤ Push [MENU]  to exit the Menu screen.

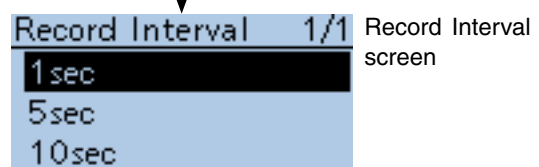
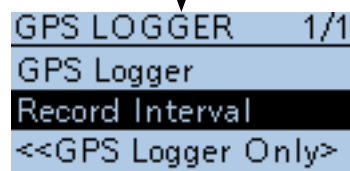
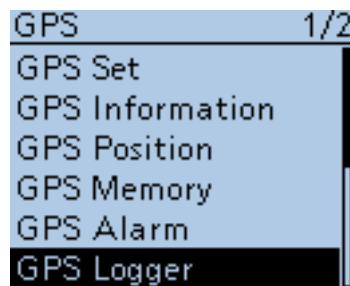



■ GPS Logger function (Continued)

**For your information— About the recorded NMEA sentence for GPS logging**

Regarding the GPS logging data of the ID-51A/E, each sentence corresponds to the NMEA standard and is recorded in the following format.

◇ **GGA sentence**

(e.g.)  $\$GPGGA,161229.487,3723.2475,N,12158.3416,W,1,07,1.0,9.0,M,25.5,M,3.0000*18<CR><LF>$

①
②
③
④
⑤
⑥
⑦
⑧
⑨
⑩
⑪
⑫

- |   |  |
|---|--|
| <ul style="list-style-type: none"> <li>① GGA protocol header (\$GPGGA)</li> <li>② <b>UTC</b> of position (16:12:29.487)</li> <li>③ Latitude (North 37° 23.2475') N=North, S=South</li> <li>④ Longitude (West 121° 58.3416') E=East, W=West</li> <li>⑤ GPS quality indicator (1)<br/>0=Fix not available or invalid, 1=SPS mode<br/>2=DGPS (SPS), 6=Estimated (Dead Reckoning) mode</li> <li>⑥ Number of satellites in use (7), 00–12</li> </ul> | <ul style="list-style-type: none"> <li>⑦ Horizontal Dilution of Precision (1.0) 0.0–50.0</li> <li>⑧ Altitude re: mean-sea-level (geoid), meters (9.0 meters)</li> <li>⑨ Geoidal separation, meters (25.5 meters)</li> <li>⑩ Age of Differential GPS data (3 seconds)</li> <li>⑪ Check Sum (*18) Error detection data started with "*" (hex code)</li> <li>⑫ End code</li> </ul> <p>*Blank shows when not positioned.</p> |
|---|--|

◇ **RMC sentence**

(e.g.)  $\$GPRMC,161229.487,A,3723.2475,N,12158.3416,W,0.13,309.62,011212,,D*10<CR><LF>$

①
②
③
④
⑤
⑥
⑦
⑧
⑨
⑩
⑪

- |   |   |
|---|---|
| <ul style="list-style-type: none"> <li>① RMC protocol header (\$GPRMC)</li> <li>② UTC of position (16:12:29.487)</li> <li>③ Status (A) A=Data valid<br/>V=Data invalid/not positioned</li> <li>④ Latitude (North 37° 23.2475') N=North, S=South</li> <li>⑤ Longitude (West 121° 58.3416') E=East, W=West</li> <li>⑥ Speed over ground (0.13 knots)</li> <li>⑦ Course Over Ground (309.62°; degrees True)<br/>0.00°–359.99°</li> </ul> | <ul style="list-style-type: none"> <li>⑧ UTC date of position ('12 Dec 1st) yymmdd</li> <li>⑨ Mode Indicator (D)<br/>A=Autonomous mode, D=DGPS,<br/>E=Estimated (dead reckoning) mode,<br/>N=Data not valid, R=Almanac data</li> <li>⑩ Check Sum (*10) Error detection data started with "*" (hex code)</li> <li>⑪ End code</li> </ul> <p>*Blank shows when not positioned.</p> |
|---|---|

◇ **GSA sentence**

(e.g.)  $\$GPGSA,A,3,07,02,26,27,09,04,,,,,15,1.8,1.0,1.5*33<CR><LF>$

①
②
③
④
⑤
⑥
⑦
⑧
⑨

- |   |   |
|---|---|
| <ul style="list-style-type: none"> <li>① GSA protocol header (\$GPGSA)</li> <li>② Mode indicator 1 (A)<br/>M=Manual, forced to operate in 2D or 3D mode<br/>A=Automatic, allowed to automatically switch 2D/3D</li> <li>③ Mode indicator 2 (3)<br/>1=Fix not available,<br/>2=2D (using satellites; less than 3),<br/>3=3D (using satellites; more than 4)</li> <li>④ ID numbers of satellites used in solution (07, 02, 26, 27, 09, 04...15)<br/>01–32 *Shows up to 12 ID's</li> </ul> | <ul style="list-style-type: none"> <li>⑤ Position Dilution of Precision (1.8) 0.0–50.0</li> <li>⑥ Horizontal Dilution of Precision (1.0) 0.0–50.0</li> <li>⑦ Vertical Dilution of Position (1.5) 0.0–50.0</li> <li>⑧ Check Sum (*33) Error detection data started with "*" (hex code)</li> <li>⑨ End code</li> </ul> <p>*Blank shows when not positioned.</p> |
|---|---|

◇ **VTG sentence**

(e.g.)  $\$GPVTG,309.62,T,,M,0.13,N,0.2,K,A*03<CR><LF>$

①
②
③
④
⑤
⑥
⑦
⑧

- |   |  |
|---|--|
| <ul style="list-style-type: none"> <li>① VTG protocol header (\$GPVTG)</li> <li>② Course Over Ground (309.62°; degrees True)<br/>0.00°–359.99°</li> <li>③ Course over ground degrees; Magnetic north</li> <li>④ Speed over ground, knots (0.13 knots)</li> <li>⑤ Speed over ground, kilometer per hour (0.2 km/hr)</li> </ul> | <ul style="list-style-type: none"> <li>⑥ Mode Indicator (A)<br/>A=Autonomous mode, D=DGPS,<br/>E=Estimated (dead reckoning) mode,<br/>N=Data not valid, R=Almanac data</li> <li>⑦ Check Sum (*03) Error detection data started with "*" (hex code)</li> <li>⑧ End code</li> </ul> <p>*Blank shows when not positioned.</p> |
|---|--|

■ GPS Logger function (Continued)

◇ Using <<GPS Logger Only>> mode

The transceiver has an exclusive GPS logger mode where only the logger is functioning.

For example, when you are traveling and don't want to use the transceiver for communication, but you do want to use just a GPS logger, this mode is useful.

NOTE:

In the "GPS Logger Only" mode, the GPS Logger function is ON, but the transceiver function is disabled, until you reboot the transceiver.

<<GPS Logger Only>> outline

1. Insert the microSD card. (p. 2-3)  
(microSD cards are not available from Icom. Purchase a card to meet your needs)
2. Turn ON the GPS receiver. (p. 10-2)
3. Turn ON the GPS Logger function. (p. 10-26)
4. Turn ON the <<GPS Logger Only>> mode.



(The <<GPS Logger Only>> mode starts.)

- ① Push [QUICK]<sup>[QUICK]</sup><sub>[SPCH]</sub>.
- ② Push D-pad(↑) to select "<<GPS Logger Only>>," then push D-pad(Ent).

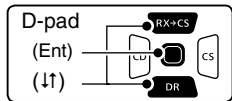

- After the "Only GPS Logger is now functioning" message appears, then the GPS position is displayed to start the GPS Logger Only mode. Also you can select the <<GPS Logger Only>> mode in the Menu screen. (p. 16-40)  
(MENU > GPS > GPS Logger > <<GPS Logger Only>>)

**To cancel the <<GPS Logger Only>> mode, reboot the transceiver by turning it OFF and then ON again.**

- When the transceiver is tuned ON, the normal GPS Logger restarts.

If the GPS Logger item in the Menu screen is set to OFF, the confirmation screen " 'GPS Logger' will be set to ON. OK?" appears after operating the step ②.

Push D-pad(↑) to select "YES," and push D-pad(Ent) to turn the GPS Logger function ON.

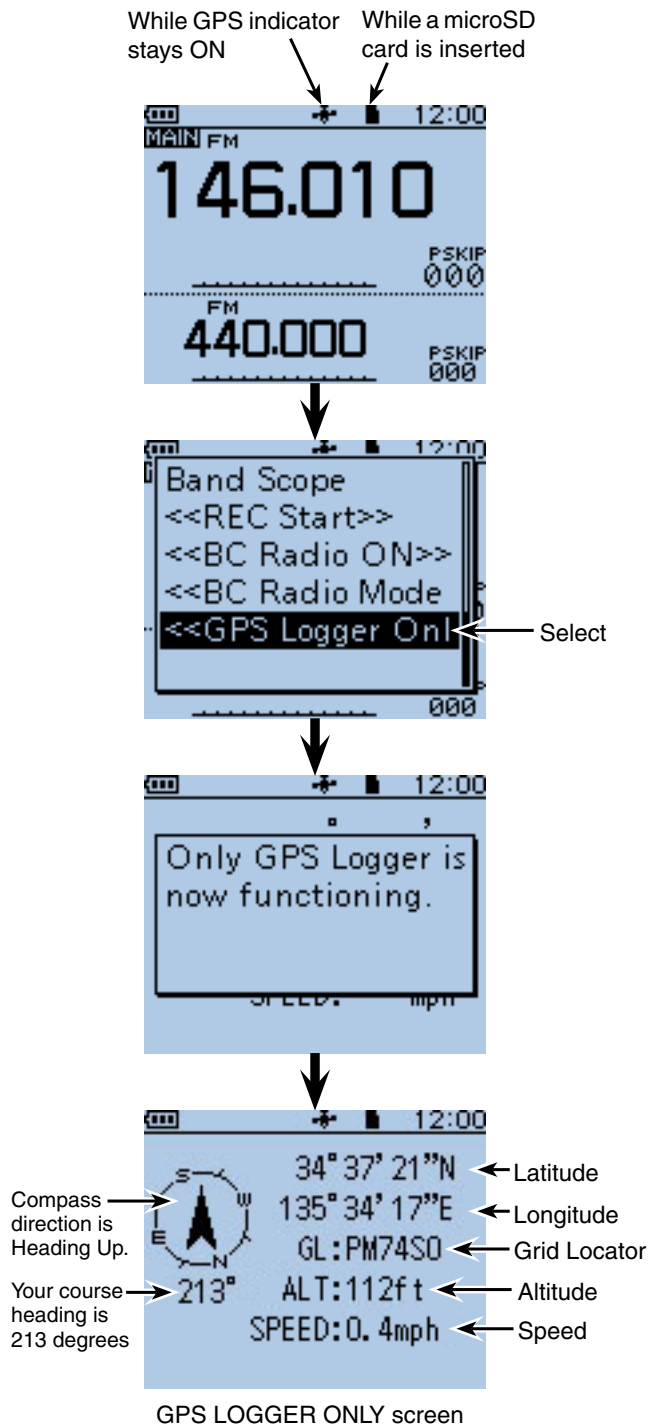
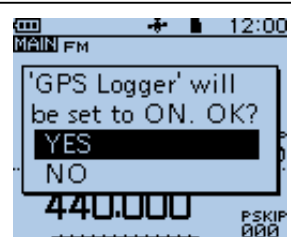

The GPS Information or Compass Direction settings can be changed. In the <<GPS Logger Only>> mode, push [QUICK]<sup>[QUICK]</sup><sub>[SPCH]</sub> to open the Sub Menu as shown to the right.

Then push D-pad(↑) to select a desired item, and then push D-pad(Ent) to enter.

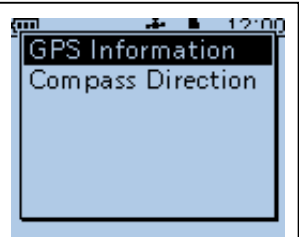

# Section 11 VOICE MEMORY FUNCTION

---

■ Recording a QSO audio .....	11-2
◇ To start recording .....	11-2
◇ To stop recording.....	11-3
■ Playing back the recorded audio .....	11-4
■ Changing the recording mode .....	11-5
■ Operation while playing back.....	11-6
◇ Fast-forward while playing .....	11-6
◇ Rewind while playing .....	11-6
◇ Pause while playing.....	11-6
◇ Playing the previously file .....	11-6
◇ Playing the next file .....	11-6
◇ Pause at the beginning of the previously file (Fast forward the file).....	11-6
◇ Pause at the beginning of the next file (Rewind the file) .....	11-6
■ Changing the skip time .....	11-7
■ VOICE PLAYER screen's description .....	11-8
■ Deleting the recorded contents (audio) .....	11-9
■ Deleting the folder .....	11-10
■ Continue to record even if no signals are received.....	11-11
■ Record the transmit and receive audio into the same file .....	11-12
■ Start to record when the [PTT] switch is pushed.....	11-13
■ Viewing the file information.....	11-14
■ Viewing the folder information .....	11-15
■ Voice Recorder function .....	11-16
◇ To start recording .....	11-16
◇ Playing back the recorded audio .....	11-17
◇ Erasing the recorded contents (audio) .....	11-18
◇ MIC Gain setting.....	11-19
◇ Changing the skip time.....	11-20
◇ Viewing the file information .....	11-21
■ Viewing the microSD card's free space and recordable time.....	11-22
■ Playing back the voice memory data on a PC.	11-23



## Recording a QSO audio

**NOTE:** BC Radio audio cannot be recorded.

You can record a QSO (communication) audio in the MAIN band onto the microSD card. The transceiver records both received and transmitted audio.

▨ If you want to record only received audio, see “Changing the recording mode” to change the recording mode to “RX only.” (p. 11-5)

### ◆ To start recording

- ① Push [QUICK]<sup>QUICK SPCH</sup> to open the Quick Menu screen.
- ② Push D-pad(↓) to select “<<REC Start>>.”

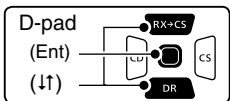

- ③ Push D-pad(Ent) to start voice recording.
  - The transceiver displays “Recording started” and automatically exits the Quick Menu screen.
  - “■” appears while the transceiver is recording.
  - “||” appears while the recording is paused.
  - Recording is continuous until you manually stop recording, or the card becomes full.
  - If the recording file’s content reaches 2GB, the transceiver automatically creates a new file, and continues recording.

▨ **NOTE:** You can start to record using the MENU screen. See p. 16-22 for details.

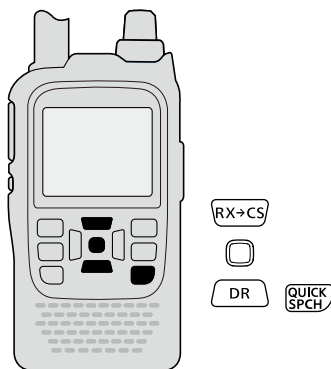

Push [QUICK]<sup>QUICK SPCH</sup>. Then, push D-pad(↓) to select.



Push D-pad(Ent) to start voice recording



While recording

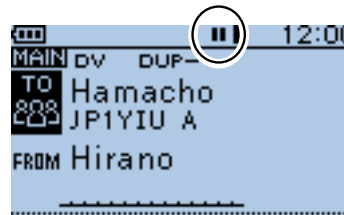

While pausing

# 11 VOICE MEMORY FUNCTION

## ■ Recording a QSO audio (Continued)

### ◇ To stop recording

- ① Push [QUICK]<sup>QUICK SPCH</sup> to open the Quick Menu screen.
- ② Push D-pad(↓) to select "<<REC Stop>>."
- ③ Push D-pad(Ent) to stop voice recording.
  - The transceiver displays "Recording stopped," and automatically exits the Quick Menu screen.

### ✓ Convenient!

When the PTT Automatic Recording function is set to ON in the MENU screen, the recording automatically starts when [PTT] is pushed.

(MENU > Voice Memo > QSO Recorder > Recorder Set > **PTT Auto REC**)

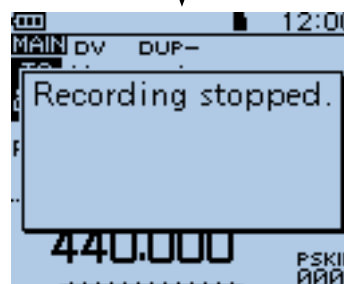
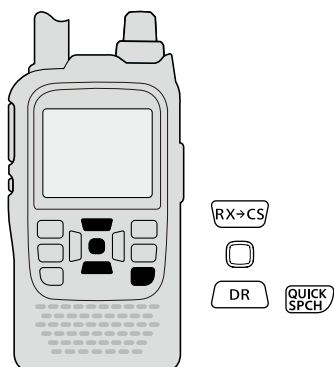

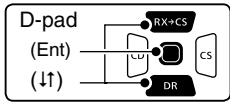

## ■ Playing back the recorded audio

- ① Push [MENU]  to enter the Menu screen.
- ② Push D-pad(↑) to select the root item (Voice Memo), and then push D-pad(Ent) to go to the next level.



(MENU > Voice Memo > QSO Recorder > **Play Files**)

- ③ Refer to the menu sequence shown directly above and push D-pad(↓) to select, and then push D-pad(Ent) to enter, one or more times until the last screen is displayed.
  - The folder list is displayed. (The folders are automatically made at recording.)
  - The folder name is composed yyyyymmdd (y: year, m: month, d: day.)
- ④ Push D-pad(↑) to select the folder that contains the file you want to play, and then push D-pad(Ent).
  - The file list is displayed.
  - The file name is composed yyyy/mm/dd hh:mm:ss (y: year, m: month, d: day, hh: hour, mm: minute, ss: second.)
- ⑤ Push D-pad(↑) to select the file that you want to play, then push D-pad(Ent) to play it back.
  - The VOICE PLAYER screen is displayed, and the file starts to playback.
- ⑥ Push [MENU]  or [CLR]  to stop the playback.
  - The file list is automatically displayed.

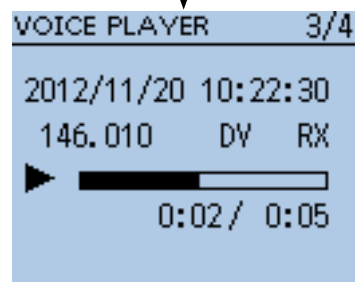
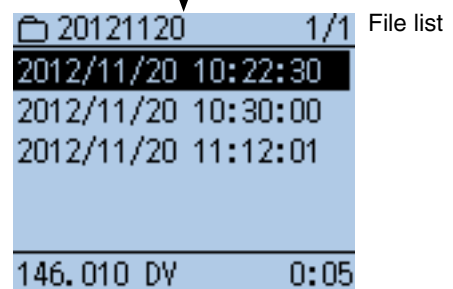
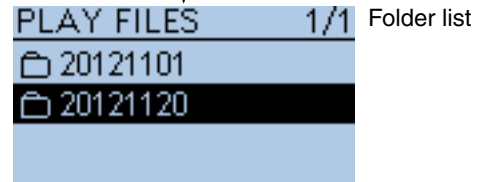
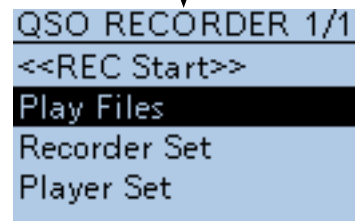
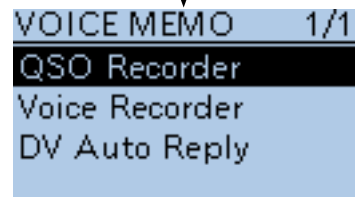
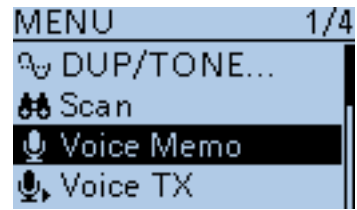
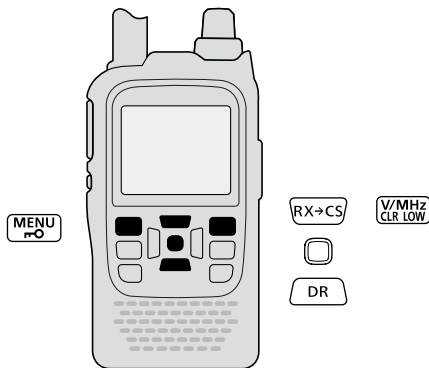

## ■ Changing the recording mode

The recording audio can be selected in the “REC Mode” item on the Menu screen.

▨ The default setting is “TX&RX” (Both transmit and receive signals are recorded).

- ① Push [MENU]  to enter the Menu screen.
- ② Push D-pad(↑) to select the root item (Voice Memo), and then push D-pad(Ent) to go to the next level.

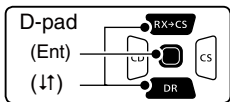

(MENU > Voice Memo > QSO Recorder > Recorder Set > **REC Mode**)

- ③ Refer to the menu sequence show directly above and push D-pad(↑) to select, and then D-pad(Ent) to enter, one or more times until the last screen is displayed.
- ④ Push D-pad(↓) to select “RX Only,” and then push D-pad(Ent) to save.
- ⑤ Push [MENU]  to set, and exit the Menu screen.

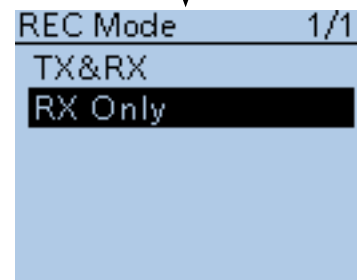
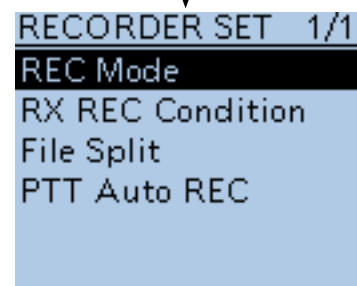
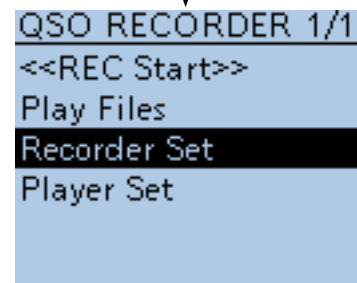
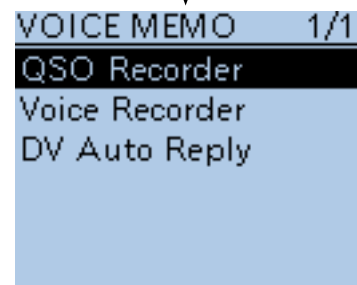
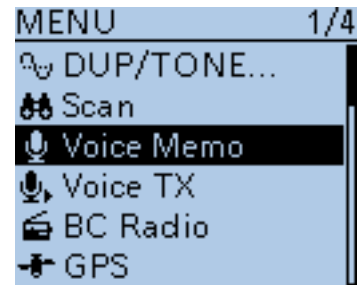
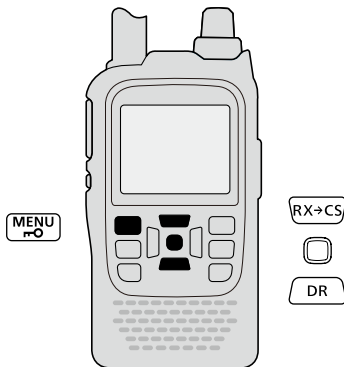

## ■ Operation while playing back

You can fast-forward or rewind while playing back.

### ◇ Fast-forward while playing

Push D-pad(→) to fast-forward. (Default: 10 seconds)  
If you want to change the fast-forward time, see “Changing the skip time.” (p. 11-7)

### ◇ Rewind while playing

Push D-pad(←) to rewind. (Default: 10 seconds)  
If you want to change the rewind time, see “Changing the skip time.” (p. 11-7)  
• If you push D-pad(←) within 1 second after starting to playback, the end of the previously recorded file will playback.

### ◇ Pause while playing

Push D-pad(Ent) to pause.  
Push D-pad(Ent) again to exit the pause.

### ◇ Playing the previously file

Push D-pad(↑) to playback the previously file.  
• In case there are other files in the folder, while the oldest file is playing back, push D-pad(↑) to start playing the beginning of the file .

### ◇ Playing the next file

Push D-pad(↓) to play the next file.  
• In case there are other files in the folder, while the most recent file is playing back, push D-pad(↓) to stop the file.

### ◇ Pause at the beginning of the previously file (Fast forward the file)

When the playback is paused anywhere within the file, push D-pad(←) to return to the beginning of the file, and pause.  
• Push D-pad(Ent) to play it back.

When the playback is paused at beginning of a file, push D-pad(←) to move to the beginning of the previous file, and pause.  
• Push D-pad(Ent) to play it back.

### ◇ Pause at the beginning of the next file (Rewind the file)

When the playback is paused, push D-pad(→) to move to the beginning of the next file, and pause.  
• Push D-pad(Ent) to play it back.

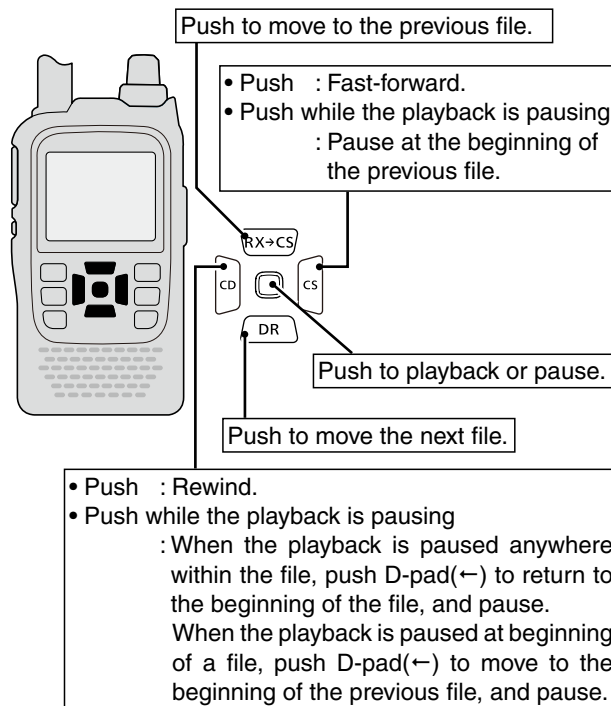

**NOTE:**  
You can also change the playback location by rotating [DIAL].  
• If you use [DIAL] to change the location, regardless of “Skip time,” you can change the location in steps of 1/20 of the file’s playback time.

## ■ Changing the skip time

You can change the skip time of fast forward and re-wind.

- ① Push [MENU]  to enter the Menu screen.
- ② Push D-pad(↑) to select the root item (Voice Memo), and then push D-pad(Ent) to go to the next level.

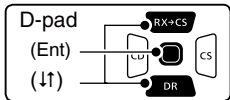

(MENU > Voice Memo > QSO Recorder > Player Set > **Skip Time**)

- ③ Refer to the menu sequence show directly above and push D-pad(↑) to select, and then D-pad(Ent) to enter, one or more times until the last screen is displayed.
- ④ Push D-pad(↑) to select the skip time of 3 seconds, 5 seconds, 10 seconds or 30 seconds, and then push D-pad(Ent) to save.
- ⑤ Push [MENU]  to exit the Menu screen.

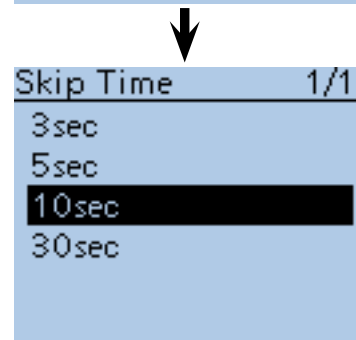
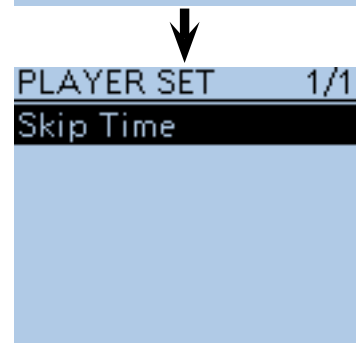
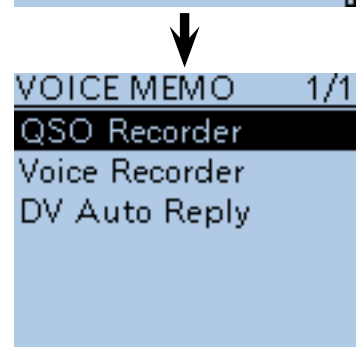
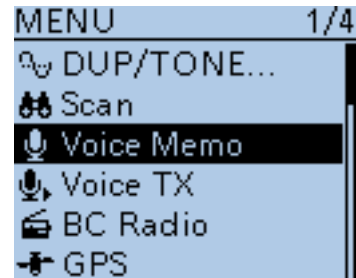
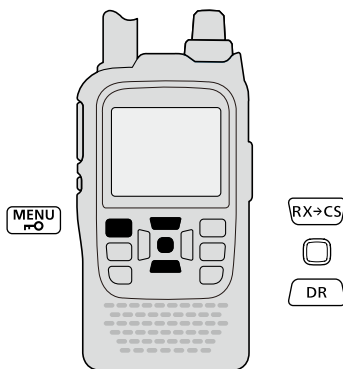

## ■ VOICE PLAYER screen's description

The displayed items are follows.

### ① File name

The playback file name is displayed.

### ② Recording information

The recorded frequency, mode and audio category are displayed.

- When the receive audio is playing back, the audio category is displayed as "RX."

- When the transmit audio is playing back, the audio category is displayed as "TX."

### ③ Playback mark

While the audio is playing back, the playback mark is displayed.

- The mark disappears while doing fast forward, rewind or pausing.

### ④ Playing back time

The playing back time is displayed.

### ⑤ Repeater call sign/name

The **repeater** call sign used in the DV mode is displayed.

When the repeater name is programmed in your repeater list, the name is also displayed.

### ⑥ Total time

The file's total playing back time is displayed.

### ⑦ Progress bar

The playing back progress bar is displayed.

### ⑧ File number/Total file number

The playing back file number, and total file number in the folder are displayed.

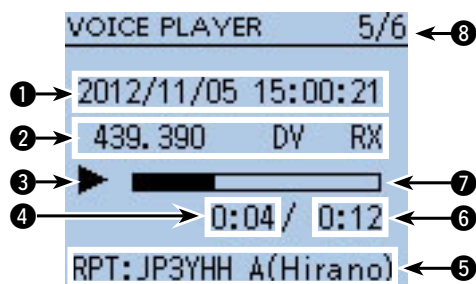

## ■ Deleting the recorded contents (audio)

- ① Push [MENU]  to enter the Menu screen.
- ② Push D-pad(↑) to select the root item (Voice Memo), and then push D-pad(Ent) to go to the next level.

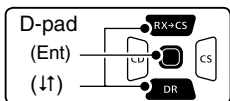

(MENU > Voice Memo > QSO Recorder > **Play files**)

- ③ Refer to the menu sequence show directly above and push D-pad(↑) to select, and then D-pad(Ent) to enter, one or more times until the last screen is displayed.
  - The folder list is displayed. (The folders are automatically made at recording.)
  - The folder name is composed yyyyymmdd (y: year, m: month, d: day.)
- ④ Push D-pad(↑) to select the folder including the file that you want to delete, then push D-pad(Ent).
  - The file list is displayed.
  - The file name is composed yyyy/mm/dd hh:mm:ss (y: year, m: month, d: day, hh: hour, mm: minute, ss: second.)
- ⑤ Push D-pad(↑) to select the file that you want to delete, then push [QUICK]  to open the Quick Menu screen.
- ⑥ Push D-pad(↑) to select “Delete,” then push D-pad(Ent).
  - The confirmation screen “Delete file?” appears.
- ⑦ Push D-pad(↓) to select “YES,” then push D-pad(Ent).
  - The selected file is deleted.

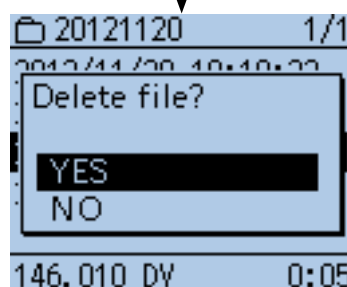
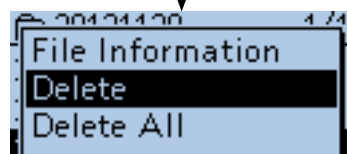
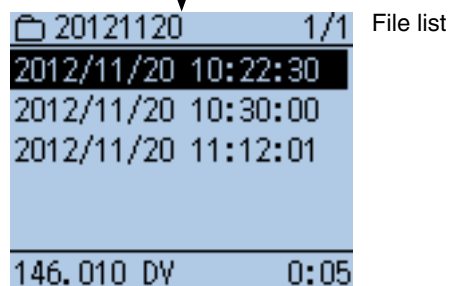
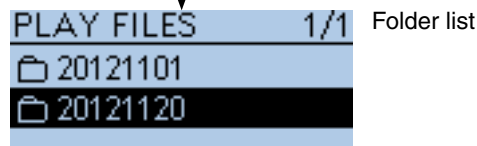
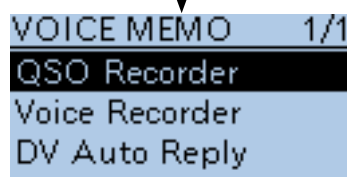
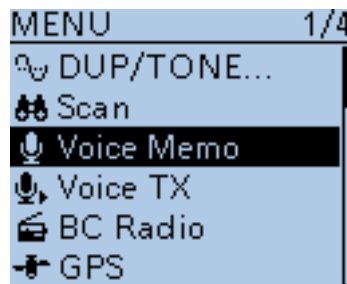
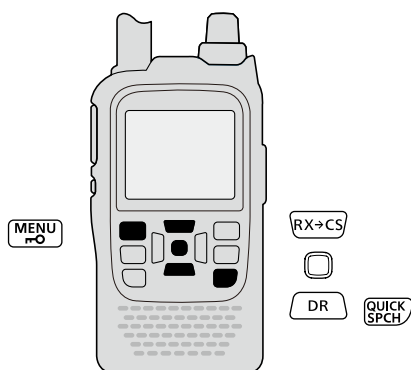

### <To delete all files>

When you want to erase all audio files in the folder at one time, select “Delete All” in step ⑥ as described above.

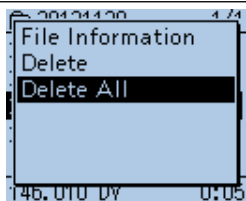



## ■ Deleting the folder

**NOTE:**

All the files in the folder are also deleted.

- ① Push [MENU] to enter the Menu screen.
- ② Push D-pad(↑) to select the root item (Voice Memo), and then push D-pad(Ent) to go to the next level.

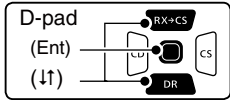

(MENU > Voice Memo > QSO Recorder > Play Files)

- ③ Refer to the menu sequence show directly above and push D-pad(↑) to select, and then D-pad(Ent) to enter, one or more times until the last screen is displayed.
  - The folder list is displayed. (The folders are automatically made at recording.)
  - The folder name is composed yyyyymmdd (y: year, m: month, d: day.)
- ④ Push D-pad(↑) to select the folder which you want to delete.
- ⑤ Push [QUICK] to open the Quick Menu screen.
- ⑥ Push D-pad(↑) to select “Delete,” then push D-pad(Ent).

  - The confirmation screen “Delete folder?” appears.

- ⑦ Push D-pad(↓) to select “YES,” then push D-pad(Ent).

  - The folder is deleted.

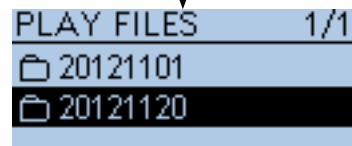
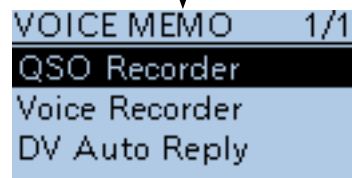
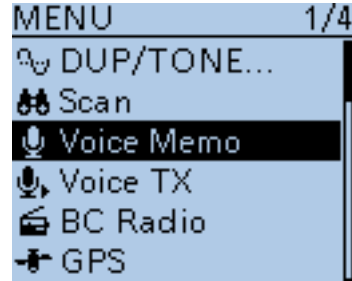

Folder list

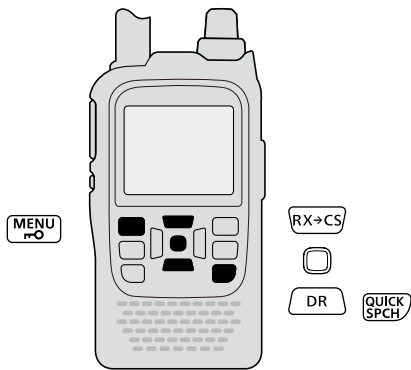
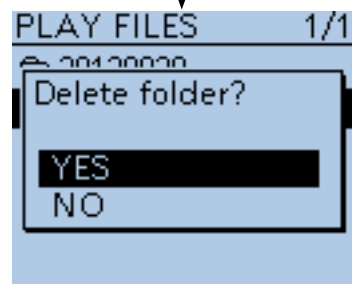
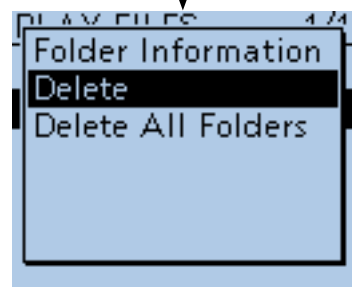

**<To delete all folders>**

When you want to erase all folders at one time, select “Delete All Folders” in step ⑥.

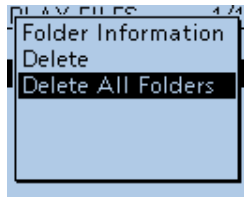

## ■ Continue to record even if no signals are received

In the default settings, the transceiver records audio only while receiving signals (the **squelch** opens).

If you want to continue recording even if no signal is received, do the following steps.

- ① Push [MENU]  to enter the Menu screen.
- ② Push D-pad(↑) to select the root item (Voice Memo), and then push D-pad(Ent) to go to the next level.

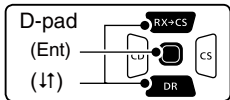

(MENU > Voice Memo > QSO Recorder > Recorder Set > **RX REC Condition**)

- ③ Refer to the menu sequence show directly above and push D-pad(↑) to select, and then D-pad(Ent) to enter, one or more times until the last screen is displayed.
- ④ Push D-pad(↓) to select “Always,” and then push D-pad(Ent) to save.
  - Always : Recording continues, even if no signals are received.
  - Squelch Auto : The transceiver records audio only while receiving signals (the squelch opens).
- ⑤ Push [MENU]  to exit the Menu screen.

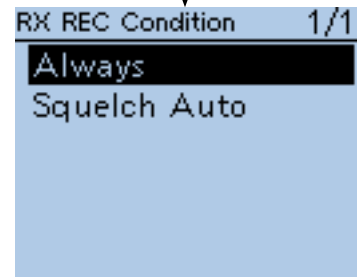
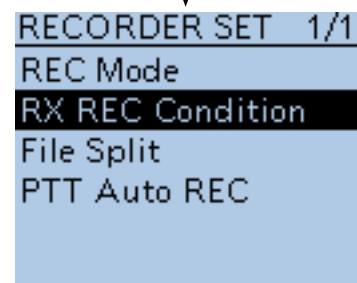
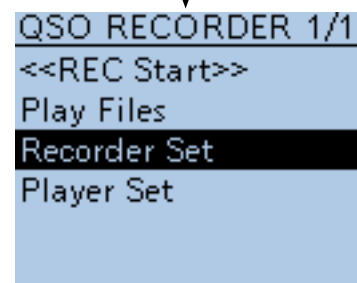
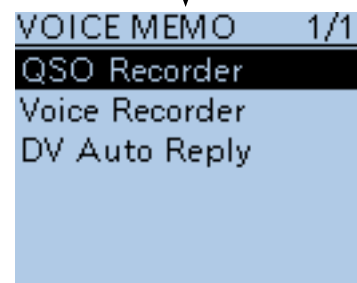
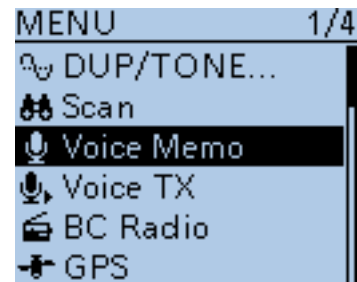
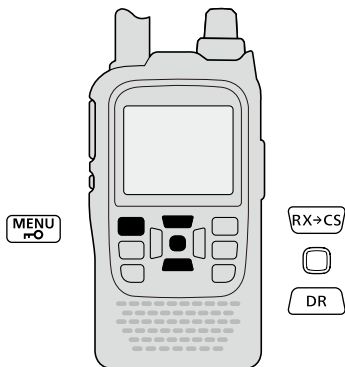

## Record the transmit and receive audio into the same file

The transceiver can record the transmit and receive audio into the same file.

- 1 Push [MENU]  to enter the Menu screen.
- 2 Push D-pad(↑) to select the root item (Voice Memo), and then push D-pad(Ent) to go to the next level.

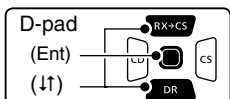

(MENU > Voice Memo > QSO Recorder > Recorder Set > **File Split**)

- 3 Refer to the menu sequence show directly above and push D-pad(↑) to select, and then D-pad(Ent) to enter, one or more times until the last screen is displayed.
- 4 Push D-pad(↓) to select "OFF," and then push D-pad(Ent) to save.
  - OFF : The transceiver records the transmit and receive audio into the same file.
  - ON : The transceiver records the transmit and receive audio into each files.

The transceiver makes separate new files for transmit and receive audio. (Default setting)

  - When you set the RX REC Condition item to "Squelch Auto," the transceiver records audio to the new file when the squelch is closed. (Voice Memo > QSO Recorder > Recorder set > **RX REC Condition**)
- 5 Push [MENU]  to exit the Menu screen.

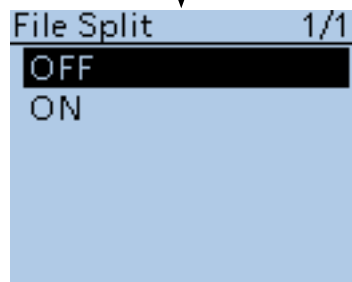
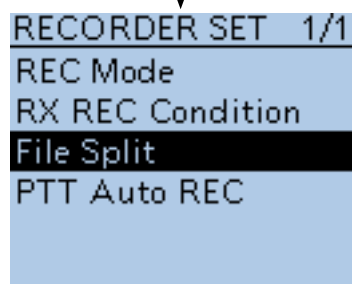
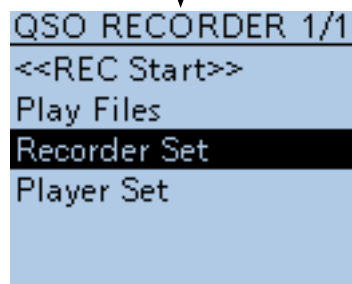
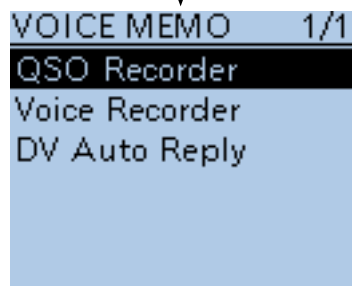
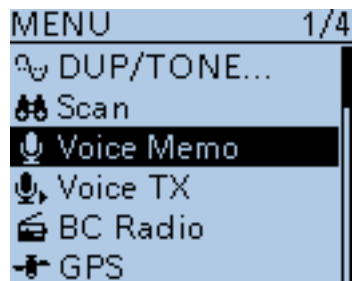
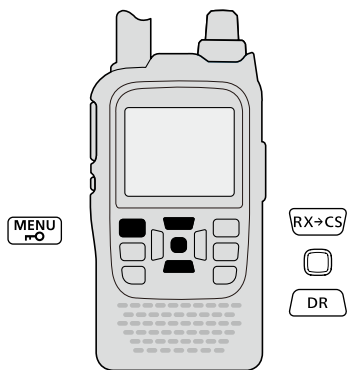

**NOTE:** Even if you set File Split item to OFF, when the recording file's content becomes 2 GB, the transceiver continues to record, but to a new file.

### About the VOICE PLAYER screen when recording into the same file

The VOICE PLAYER screen shows information that is recorded first.

When the receive audio was recorded first, the transmit audio information is not displayed on the screen.

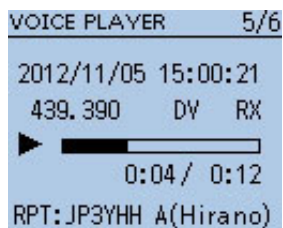

## ■ Start to record when the [PTT] switch is pushed

The transceiver starts to record the transmitted audio at the same time the [PTT] switch is pushed.

After transmitting, the transceiver receives signal in a given amount of time, it also records the received audio. Therefore, you can record all communication audio to use this function.

- ① Push [MENU]  to enter the Menu screen.
- ② Push D-pad(↑) to select the root item (Voice Memo), and then push D-pad(Ent) to go to the next level.

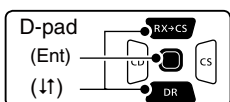

(MENU > Voice Memo > QSO Recorder > Recorder Set > **PTT Auto REC**)

- ③ Refer to the menu sequence show directly above and push D-pad(↑) to select, and then D-pad(Ent) to enter, one or more times until the last screen is displayed.
- ④ Push D-pad(↑) to select “ON,” then push D-pad(Ent) to save.
  - OFF : The transceiver does not start to record when the [PTT] switch is pushed.
  - ON : The transceiver starts to record when the [PTT] switch is pushed.
- ⑤ Push [MENU]  to exit the Menu screen.

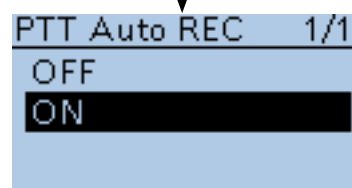
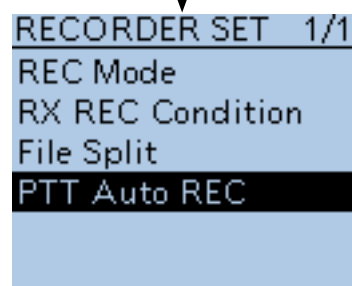
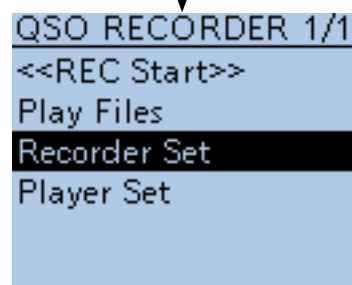
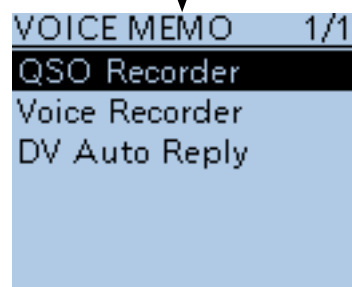
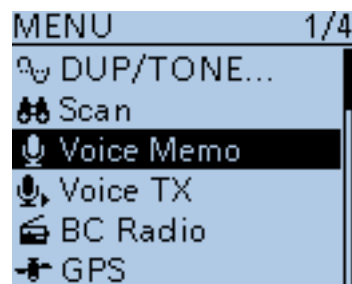
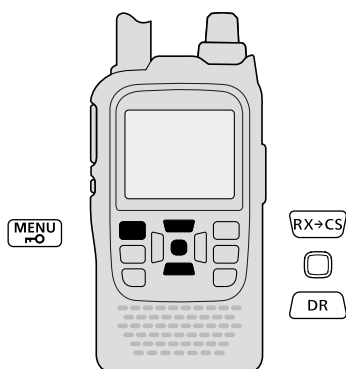

**NOTE: When you set PTT AUTO REC to ON, see the notes below.**



- The transceiver also starts to record audio when pushing the optional microphone's [PTT] switch, transmitting using with the VOX function or CI-V remote controller.
- All transmit audio is recorded when “TX&RX” is set in the “REC Mode” item on the Menu screen.
- When the transceiver receives a signal less than 10 seconds after transmitting, the transceiver also records the receive audio.
- In addition, when the transceiver receives a signal less than 10 seconds after the signal is received, it also records the receive audio.

## ■ Viewing the file information

The transceiver can display the recorded file's frequency, mode, date, and so on.

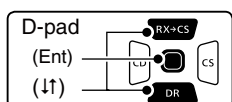
- ① Push [MENU]  to enter the Menu screen.
- ② Push D-pad(↑) to select the root item (Voice Memo), and then push D-pad(Ent) to go to the next level.



- ③ Refer to the menu sequence show directly above and push D-pad(↑) to select, and then D-pad(Ent) to enter, one or more times until the last screen is displayed.
  - The folder list is displayed. (The folders are automatically made at recording.)
  - The folder name is composed yyyyymmdd (y: year, m: month, d: day.)
- ④ Push D-pad(↑) to select the folder that contains the file you want to view, and then push D-pad(Ent).
  - The file list is displayed.
  - The file name is composed yyyy/mm/dd hh:mm:ss (y: year, m: month, d: day, hh: hour, mm: minute, ss: second.)
- ⑤ Push D-pad(↑) to select the file that you want to view the information, then push [QUICK]  to open the Quick Menu screen.
- ⑥ Push D-pad(↑) to select "File Information," then push D-pad(Ent).
  - The information screen appears.
- ⑦ Push D-pad(Ent) to exit the information screen.
- ⑧ Push [MENU]  to exit the Menu screen.



### Example of file information screens (The display items differ, depending on the recording contents.)

#### • Transmit Information screen

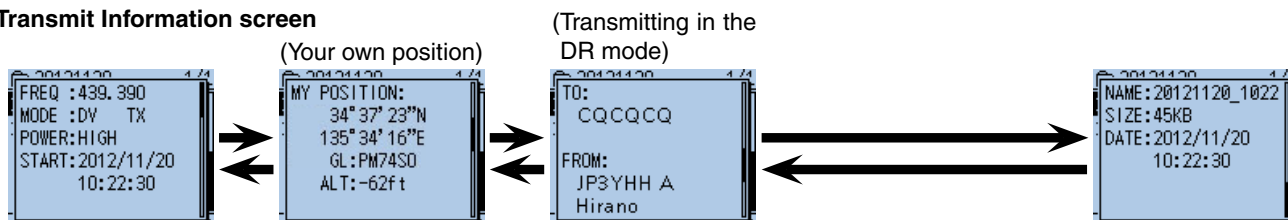

#### • Receive Information screen

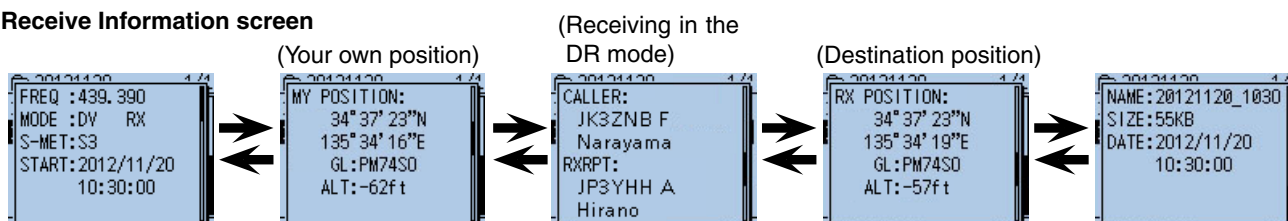



## ■ Viewing the folder information

The transceiver can display the folder's name, number of the files in the folder, total capacity of the files and date.

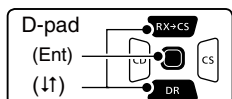
- ① Push [MENU]  to enter the Menu screen.
- ② Push D-pad(↑) to select the root item (Voice Memo), and then push D-pad(Ent) to go to the next level.



(MENU > Voice Memo > QSO Recorder > Play Files)

- ③ Refer to the menu sequence show directly above and push D-pad(↑) to select, and then D-pad(Ent) to enter, one or more times until the last screen is displayed.
  - The folder list is displayed. (The folders are automatically made at recording.)
  - The folder name is composed yyyyymmdd (y: year, m: month, d: day.)
- ④ Push D-pad(↑) to select the folder want to view the folder information, then push [QUICK]  to open the Quick Menu screen.
- ⑤ Push D-pad(↑) to select “Folder Information,” then push D-pad(Ent).
  - The information screen appears.
- ⑥ Push D-pad(Ent) to exit the information screen.
- ⑦ Push [MENU]  to exit the Menu screen.

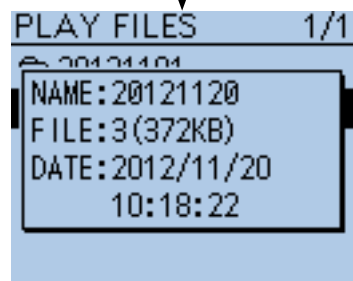
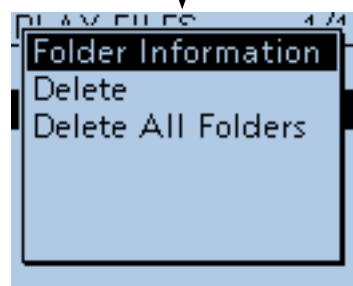
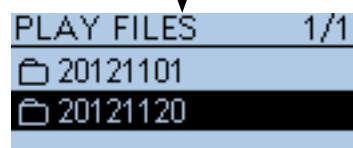
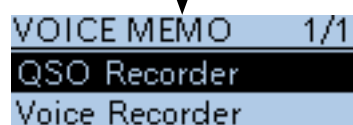
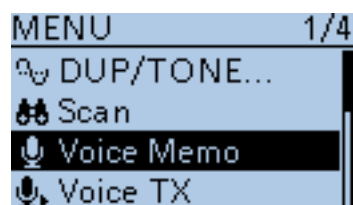
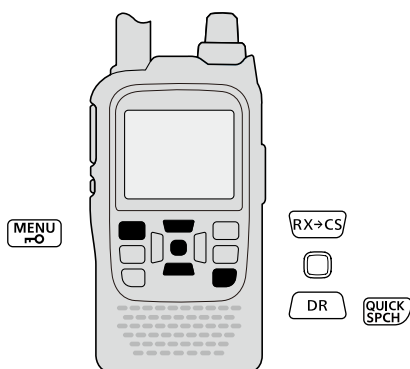

## ■ Voice Recorder function

The microphone audio, including audio from an external microphone, can be recorded for your convenience.

- Depending on the microSD card capacity, you may continuously record up to a maximum of about 37 hours. If the file size exceeds 2 GB, a new file is automatically created in the same folder, and the recorded voice audio is saved there.

### ◇ To start recording

- ① Push [MENU]  to enter the Menu screen.
- ② Push D-pad(↑) to select the root item (Voice Memo), and then push D-pad(Ent) to go to the next level.

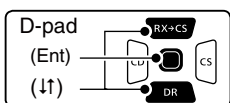

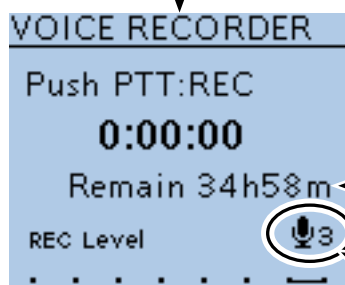
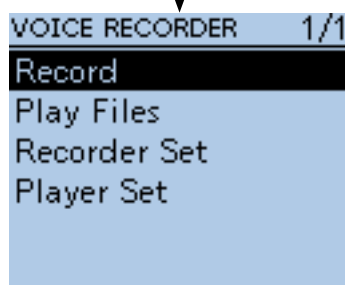
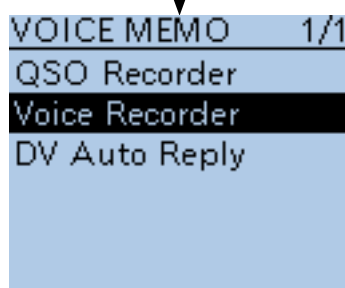
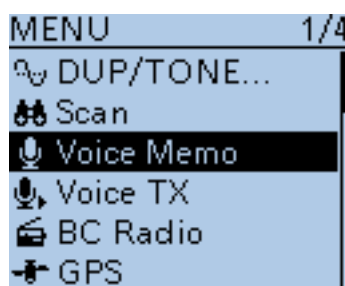
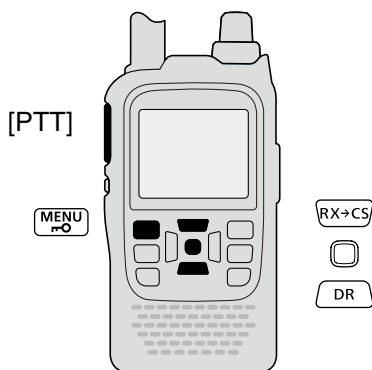

(MENU > Voice Memo > **Voice Recorder**)

- ③ Refer to the menu sequence shown directly above and push D-pad(↑) to select “Record,” and then D-pad(Ent).
- The VOICE RECORDER screen appears.
- ④ Push [PTT] to start recording.
- “Recording” appears and the microphone audio recording starts.
- ⑤ Push [PTT] again to stop.
- The information screen appears.
- ⑥ Push [MENU]  to exit the Menu screen.



### NOTE:

While recording a QSO, a voice recorder cannot be made, and the screen shown to the right appears. In that case, push [MENU]  to exit the Menu screen, and push [QUICK] . Push D-pad(↑) to select “Stop Recording” to stop the QSO recording.

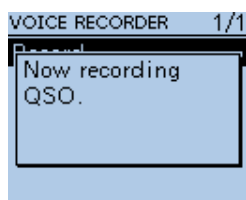

Even if the external microphone is connected, the internal microphone's voice audio is recorded when the transceiver's [PTT] is held. To record the external microphone's voice audio, hold down the external microphone's [PTT].

# 11 VOICE MEMORY FUNCTION



## ■ Voice Recorder function (Continued)

### ◇ Playing back the recorded audio

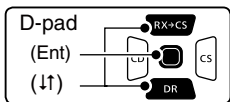
- ① Push [MENU]  to enter the Menu screen.
- ② Push D-pad(↑) to select the root item (Voice Memo), and then push D-pad(Ent) to go to the next level.



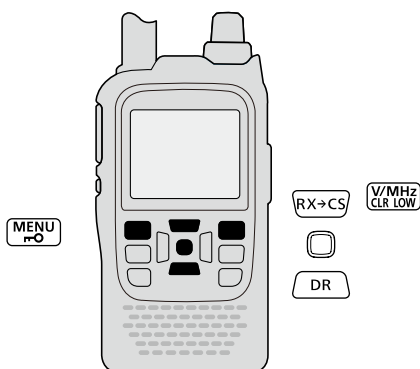

(MENU > Voice Memo > Voice Recorder > **Play Files**)

- ③ Refer to the menu sequence shown directly above and push D-pad(↑) to select, and then push D-pad(Ent) to enter, one or more times until the last screen is displayed.
  - The folder list is displayed. (The folders are automatically made at recording.)
  - The folder name is composed yyyyymmdd (y: year, m: month, d: day.)
- ④ Push D-pad(↑) to select the folder that contains the file you want to play, and then push D-pad(Ent).
  - The file list is displayed.
  - The file name is composed yyyy/mm/dd hh:mm:ss (y: year, m: month, d: day, hh: hour, mm: minute, ss: second.)
- ⑤ Push D-pad(↑) to select the file that you want to play, then push D-pad(Ent) to play it back.
  - The VOICE PLAYER screen is displayed, and the file starts to playback.
  - The next file continuously starts to playback.
  - Push D-pad(Ent) to pause.
- ⑥ Push [MENU]  or [CLR]  to stop the playback.
  - The file list is automatically displayed.



### NOTE:

While recording a QSO, a voice recorder recorded audio cannot be played back, and the screen shown to the right appears. In that case, push [MENU]  to exit the Menu screen, and push [QUICK] . Push D-pad(↑) to select "Stop Recording" to stop the QSO recording.

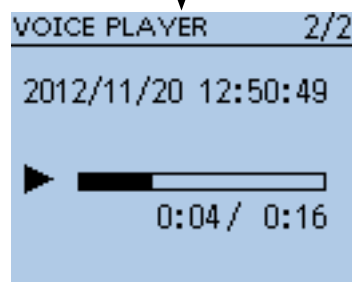
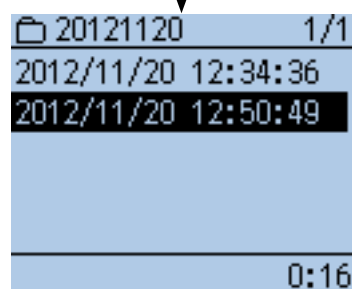
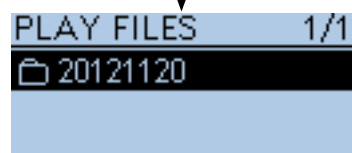
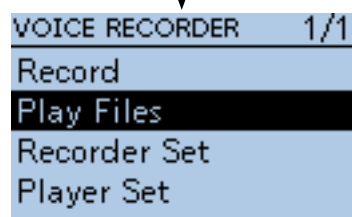
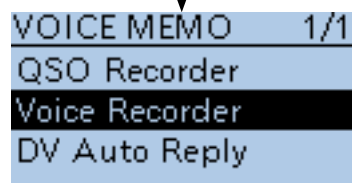
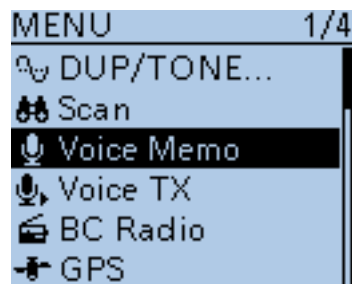
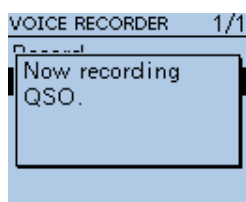



# 11 VOICE MEMORY FUNCTION

## ■ Voice Recorder function (Continued)

### ◇ Erasing the recorded contents (audio)

- ① Push [MENU]  to enter the Menu screen.
- ② Push D-pad(↑) to select the root item (Voice Memo), and then push D-pad(Ent) to go to the next level.

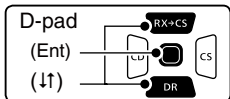

(MENU > Voice Memo > Voice Recorder > **Play files**)

- ③ Refer to the menu sequence show directly above and push D-pad(↓) to select, and then D-pad(Ent) to enter, one or more times until the last screen is displayed.
  - The folder list is displayed. (The folders are automatically made at recording.)
  - The folder name is composed yyyyymmdd (y: year, m: month, d: day.)
- ④ Push D-pad(↓) to select the folder including the file that you want to erase, then push D-pad(Ent).
  - The file list is displayed.
  - The file name is composed yyyy/mm/dd hh:mm:ss (y: year, m: month, d: day, hh: hour, mm: minute, ss: second.)
- ⑤ Push D-pad(↓) to select the file that you want to erase, then push [QUICK]  to open the Quick Menu screen.
- ⑥ Push D-pad(↓) to select “Delete,” then push D-pad(Ent).
  - The confirmation screen “Delete file?” appears.
- ⑦ Push D-pad(↓) to select “YES,” then push D-pad(Ent).
  - The selected file is erased.

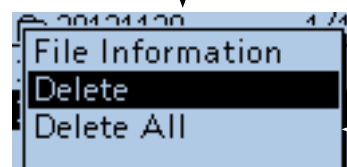
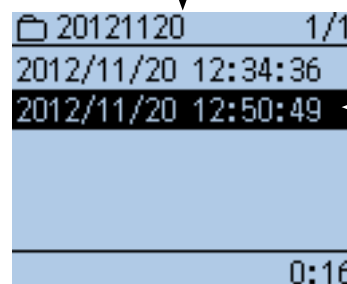
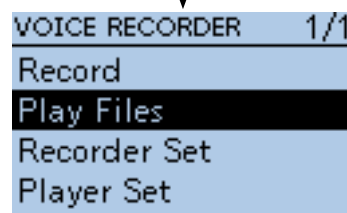
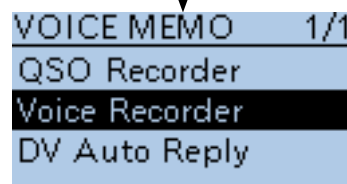
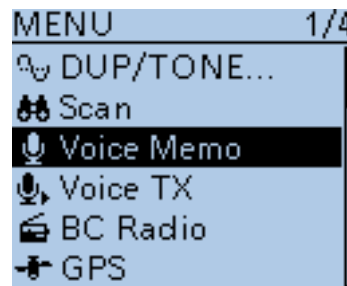
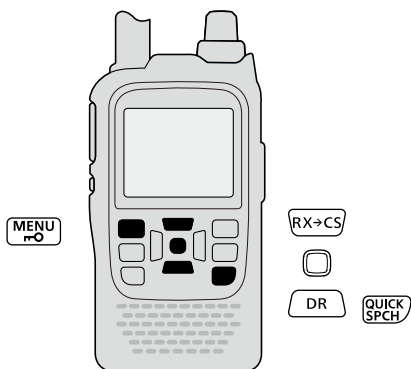

The file that you want to erase.

To erase all files at one time, select “Delete All!”

#### <To erase a folder>

When you want to erase a folder, select the folder that you want to erase in step ③, then push [QUICK] . And push D-pad(↓) to select “Delete,” then push D-pad(Ent).

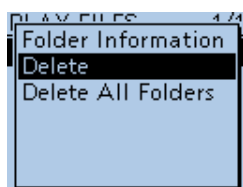

#### <To erase all folders>

When you want to erase all folders, push [QUICK]  in step ③. And push D-pad(↓) to select “Delete All Folders,” then push D-pad(Ent).

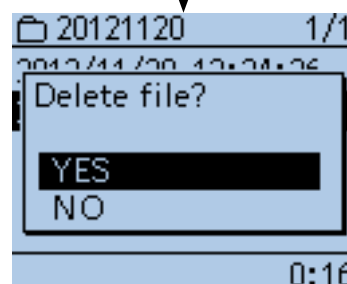
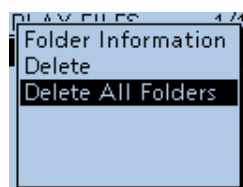

# 11 VOICE MEMORY FUNCTION

## ■ Voice Recorder function (Continued)

### ◇ MIC Gain setting

- ① Push [MENU]  to enter the Menu screen.
- ② Push D-pad(↑) to select the root item (Voice Memo), and then push D-pad(Ent) to go to the next level.

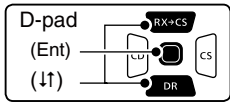

(MENU > Voice Memo > Voice Recorder > Recorder Set > **MIC Gain**)

- ③ Refer to the menu sequence show directly above and push D-pad(↑) to select, and then D-pad(Ent) to enter, one or more times until the last screen is displayed.
- ④ Push D-pad(↑) to select the folder including the file that you want to erase, then push D-pad(Ent).
  - The MIC Gain screen is displayed.
- ⑤ Push D-pad(↑) to set the internal microphone sensitivity to between 1 (minimum sensitivity) and 4 (maximum sensitivity), to suit your needs.
  - Higher values make the microphone more sensitive to your voice.
- ⑥ Push [MENU]  to exit the Menu screen.

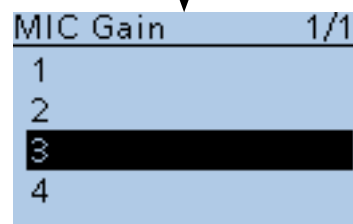
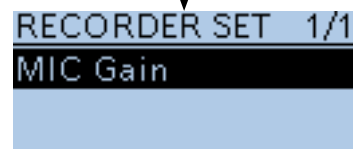
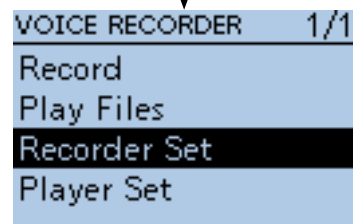
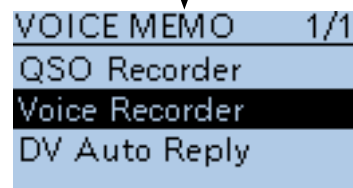
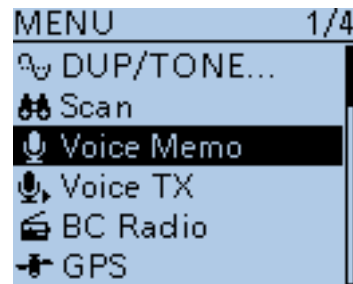
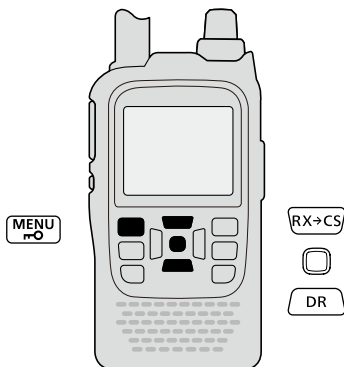

The selected gain level is displayed here.

### MIC Gain setting in the VOICE RECORDER screen

While in the VOICE RECORDER screen as shown to the right, push [QUICK] . And then push D-pad(Ent) to set the internal microphone sensitivity.

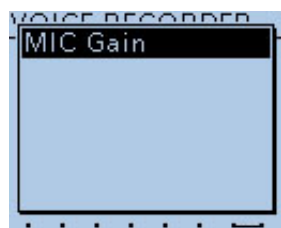

# 11 VOICE MEMORY FUNCTION

## ■ Voice Recorder function (Continued)

### ◇ Changing the skip time

You can change the skip time of fast forward and re-wind.

- ① Push [MENU]  to enter the Menu screen.
- ② Push D-pad(↓) to select the root item (Voice Memo), and then push D-pad(Ent) to go to the next level.

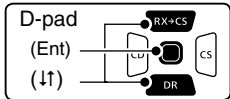

(MENU > Voice Memo > Voice Recorder > Player Set > Skip Time)

- ③ Refer to the menu sequence show directly above and push D-pad(↓) to select, and then D-pad(Ent) to enter, one or more times until the last screen is displayed.
- ④ Push D-pad(↓) to select the skip time of 3 seconds, 5 seconds, 10 seconds or 30 seconds, and then push D-pad(Ent) to save.
- ⑤ Push [MENU]  to exit the Menu screen.

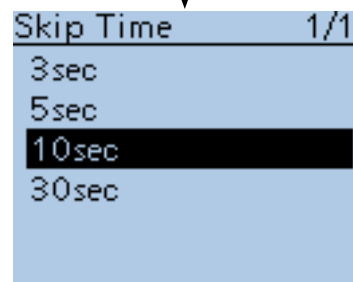
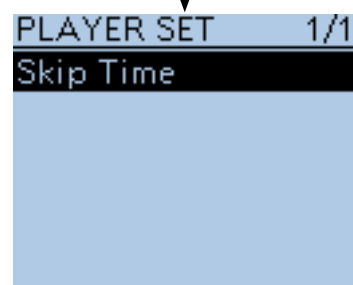
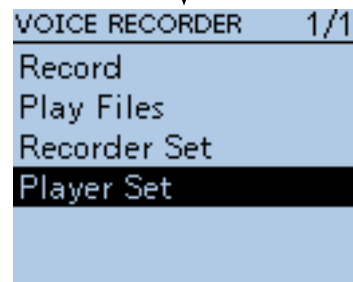
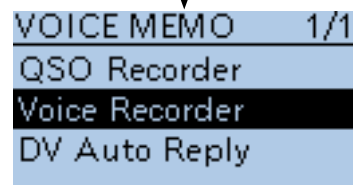
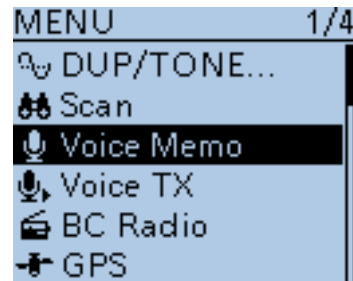
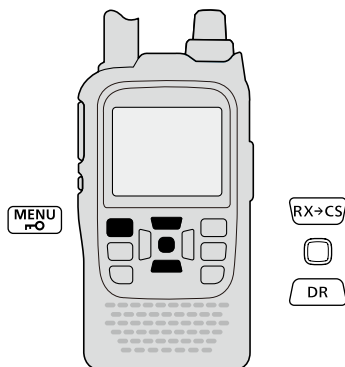

# 11 VOICE MEMORY FUNCTION

## ■ Voice Recorder function (Continued)



### ◇ Viewing the file information

The transceiver can display the recorded file's frequency, mode, date, and so on.

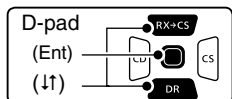
- ① Push [MENU]  to enter the Menu screen.
- ② Push D-pad(↑) to select the root item (Voice Memo), and then push D-pad(Ent) to go to the next level.



(MENU > Voice Memo > Voice Recorder > **Play Files**)

- ③ Refer to the menu sequence show directly above and push D-pad(↑) to select, and then D-pad(Ent) to enter, one or more times until the last screen is displayed.
  - The folder list is displayed. (The folders are automatically made at recording.)
  - The folder name is composed yyyyymmdd (y: year, m: month, d: day.)
- ④ Push D-pad(↑) to select the folder including the file that you want to view the information, then push D-pad(Ent).
- The file list is displayed.
  - The file name is composed yyyy/mm/dd hh:mm:ss (y: year, m: month, d: day, hh: hour, mm: minute, ss: second.)
- ⑤ Push D-pad(↑) to select the file that you want to view the information, then push [QUICK]  to open the Quick Menu screen.
- ⑥ Push D-pad(↑) to select "File Information," then push D-pad(Ent).
  - The information screen appears.
- ⑦ Push D-pad(Ent) to exit the information screen.
- ⑧ Push [MENU]  to exit the Menu screen.

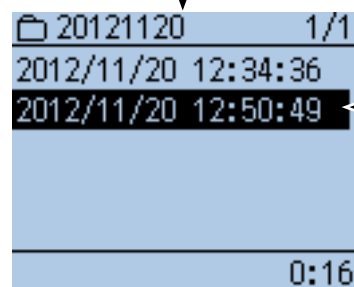
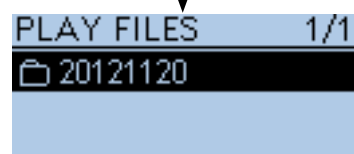
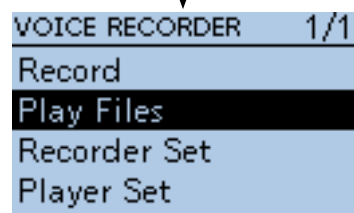
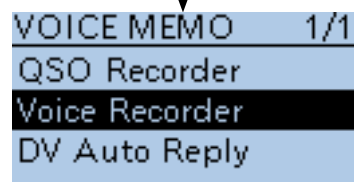
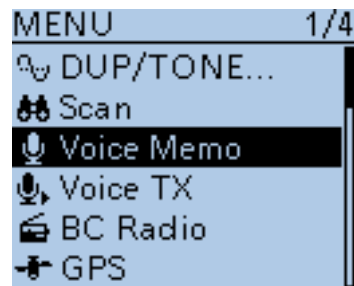
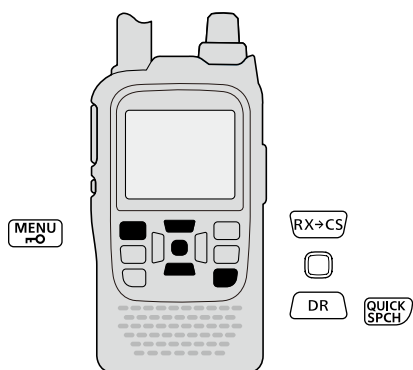

← The file that you want to view

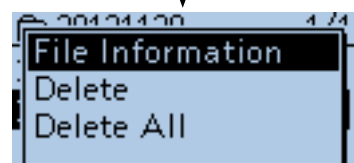

### <To view a folder information>

When you want to view a folder information, select the folder that you want to view the information in step ③, then push [QUICK] . And push D-pad(↑) to select "Folder Information," then push D-pad(Ent).

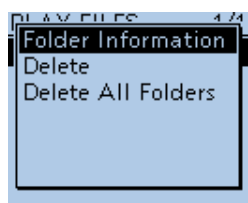

## ■ Viewing the microSD card's free space and recordable time

- ① Push [MENU]  to enter the Menu screen.
- ② Push D-pad(↓) to select the root item (SD Card), and then push D-pad(Ent).
- ③ Push D-pad(↓) to select "SD Card Info," and then push D-pad(Ent) to display the SD Card Information.

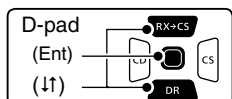

• The information screen appears.

- ④ Push D-pad(Ent) to exit the information screen.
- ⑤ Push [MENU]  to exit the Menu screen.

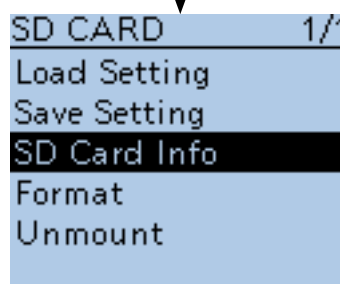
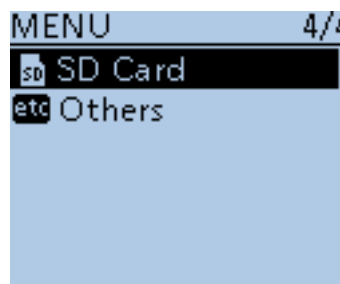
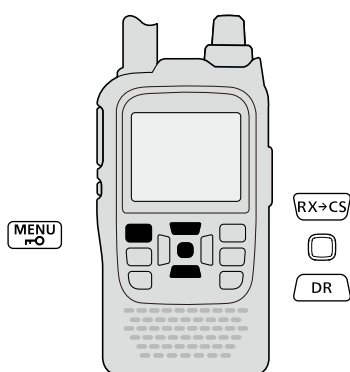

## ■ Playing back the voice memory data on a PC

You can also playback the voice memory data on a PC.

However, the recorded information (frequency, date, and so on) are not displayed.

- Microsoft® Windows® 7 is used for the description.
- When you copy the voice memory data from the microSD card to the PC's hard disk drive, you also operate same as following steps for playing back data.
- (e.g.) A memory card reader (3rd party products) is connected to the PC, and insert the microSD card into the reader. Then playing back the voice memory data in the card.

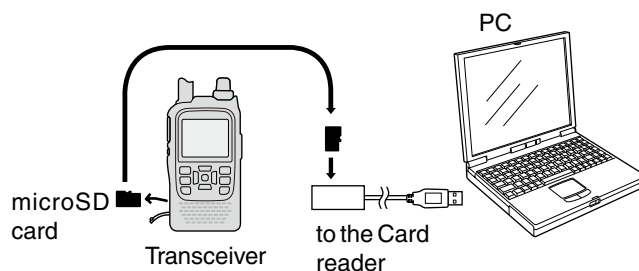

- ① Connect the memory card reader (purchase locally) to the PC, and then insert the microSD card into the reader.
  - If your PC has a microSD card drive, insert the card into the drive.
- ② When the microSD card is inserted in the microSD card drive of the PC or the microSD card reader, the screen appears as shown to the right.
  - The [ID-51] folder appears.
- ③ Double-click the [ID-51] folder.

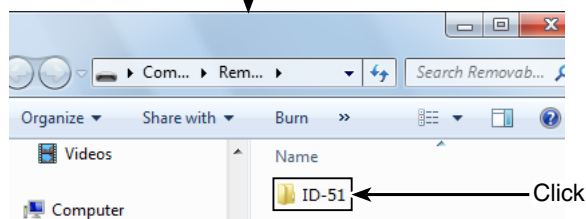
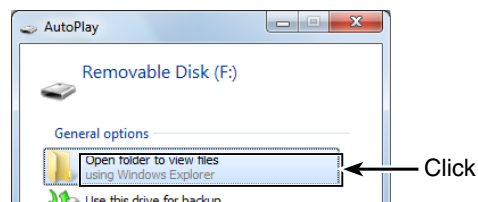

- ④ Double-click the [Voice] or [VoiceRec] folder.
  - To playback the QSO voice audio, double-click the [Voice] folder.
  - To playback the voice recorder audio, double-click the [VoiceRec] folder.

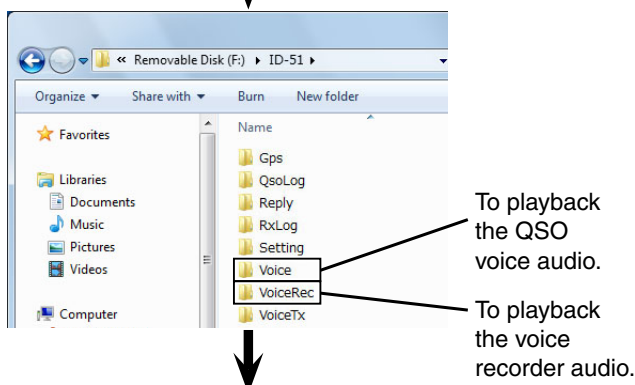

- ⑤ Double-click the folder in which the file you want to playback is stored. (e.g. 20121120 folder)
- ⑥ To playback the file, double-click it. (e.g. 20121120\_032854.wav)

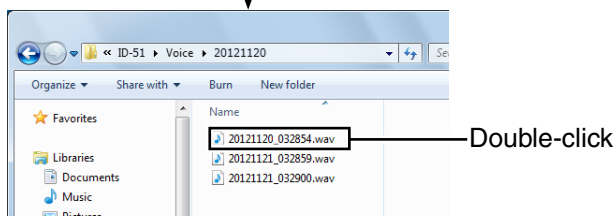
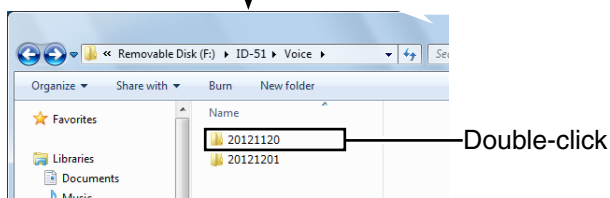

**NOTE:**

- The operations while playing back may differ, depending on the software. Therefore, refer to the software's instruction manual for details.
- When the file does not playback, even if you double-click the file, download appropriate software like Windows Media® Player.

# Section 12 MEMORY CHANNEL PROGRAMMING

---

- General description ..... 12-2
  - ◇ Memory channel contents ..... 12-2
- Memory channel selection..... 12-3
- Selecting a call channel..... 12-3
- Memory channel programming..... 12-4
- Copying memory and Call channel contents ..... 12-5
  - ◇ Memory or Call channel⇒VFO..... 12-5
  - ◇ Memory or Call channel⇒Another memory or Call channel..... 12-6
- Memory bank setting ..... 12-7
  - ◇ Assigning a memory channel to a memory bank ..... 12-7
  - ◇ Directly programming into a memory bank.... 12-8
- Memory bank selection ..... 12-9
- Programming memory/bank/scan name ..... 12-10
  - ◇ Programming memory name, bank name or scan name ..... 12-10
- Selecting a memory name display ..... 12-12
- Memory clearing..... 12-13

### ■ General description

The Memory mode is very useful to quickly select often-used operating settings.

The transceiver has 500 regular memory channels, 50 scan edge channels (25 pairs) and 4 call channels. Also, 26 memory banks, A to Z, can be used to store groups of operating channels, and so on. Up to 100 channels can be assigned to a bank.

### ◇ Memory channel contents

The following information can be programmed into memory channels:

- Operating frequency
- Operating mode
- Duplex direction (DUP+/DUP-) with a frequency offset
- Subaudible tone encoder, tone squelch or DTCS squelch ON/OFF
- Subaudible tone frequency, tone squelch frequency or DTCS code with polarity
- Scan skip setting
- Memory bank
- Memory name
- Tuning step
- UR Station call sign
- R1/R2 call sign
- Digital Call sign squelch or Digital code squelch ON or OFF
- Digital code



**NOTE:** Memory data can be erased by static electricity, electric transients, and other causes. In addition, they can be erased by a malfunction and during repairs. Therefore, we recommend that memory data be backed up or be saved to a microSD card or to a PC.

- The microSD card is not available from Icom. Purchase a microSD card to meet your needs.
- The CS-51 cloning software that is included on the supplied CD can also be used to backup the memory data.
- The optional OPC-2218LU is required to connect the transceiver and a PC.



## Memory channel selection

The Memory mode is used for operation on memory channels, which store programmed frequencies, call signs and other data.

- ① Push [M/CALL]  one or more times to select the Memory mode.
  - “MR” appears when the Memory mode is selected.
  - Push [M/CALL]  again to select the Memory mode or Weather channel mode\*. The Memory mode, Call channel mode or Weather channel mode\* are alternately selected.

\*Appears only for the U.S.A. version transceivers.
- ② Rotate [DIAL] to select a desired memory channel.
  - Only programmed memory channels can be selected.
  - See page 12-4 for memory programming details.

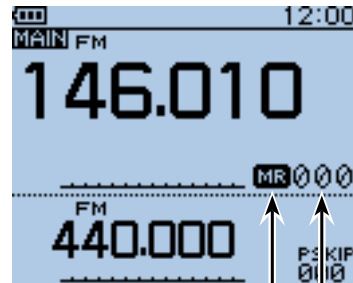

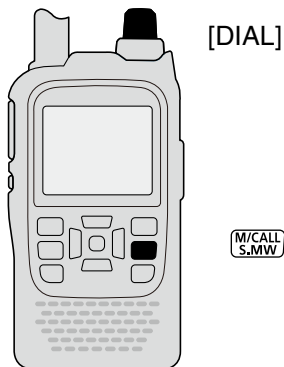

Appears

Rotate [DIAL] to select the memory channel number



## Selecting a call channel

Call channels are used for quick recall of most often-used operating settings.

- ① Push [M/CALL]  one or more times to select the Call channel mode.
  - Push [M/CALL]  again to select the Memory mode or Weather channel mode\*. The Memory mode, Call channel mode or Weather channel mode\* are alternately selected.

\*Appears only in the U.S.A. version transceivers.
- ② Rotate [DIAL] to select the Call channel between “C0” to “C3.”



Rotate [DIAL] to select

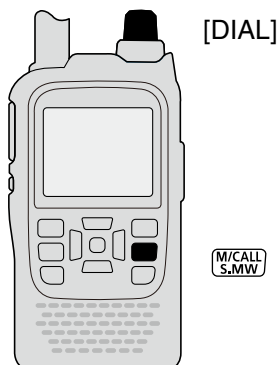

## Memory channel programming

- ① Push [V/MHz]<sup>(V/MHz CLR LOW)</sup> to select the VFO mode.
- ② Set a desired frequency and operating mode:
  - Rotate [DIAL] to set a desired frequency. (Example: 146.030)
  - Push [MODE]<sup>(MODE SCAN)</sup> one or more times to select a desired operating mode. (Example: FM mode)
  - Set the duplex direction, frequency offset, tone squelch, and so on, if needed.
- ③ Hold down [S.MW]<sup>(M/CALL S.MW)</sup> for 1 second to enter the Select Memory write mode.
  - 1 short and 1 long beep sound.
  - The memory channel number blinks, and memory contents are displayed.
- ④ Rotate [DIAL] to select a desired channel to be programmed. (Example: Channel 11)
- ⑤ Hold down [S.MW]<sup>(M/CALL S.MW)</sup> for 1 second to program, and then return to the VFO mode.
  - 3 beeps sound.
  - Before returning to the VFO mode, the programmed memory contents are briefly displayed.
  - The Memory channel number automatically increases when continuing to hold down [S.MW]<sup>(M/CALL S.MW)</sup> for 1 second after programming.

**NOTE:** Push [CLR]<sup>(V/MHz CLR LOW)</sup> to cancel the program and exit the Select Memory write mode before memory programming.

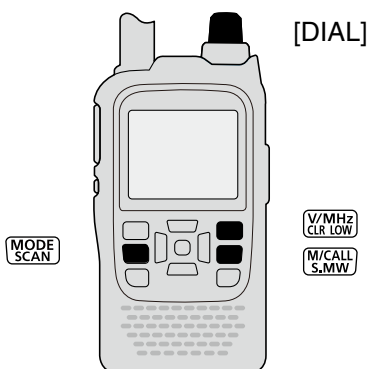

Example: Programming 146.030 MHz/FM mode into memory channel 11 (a blank channel).

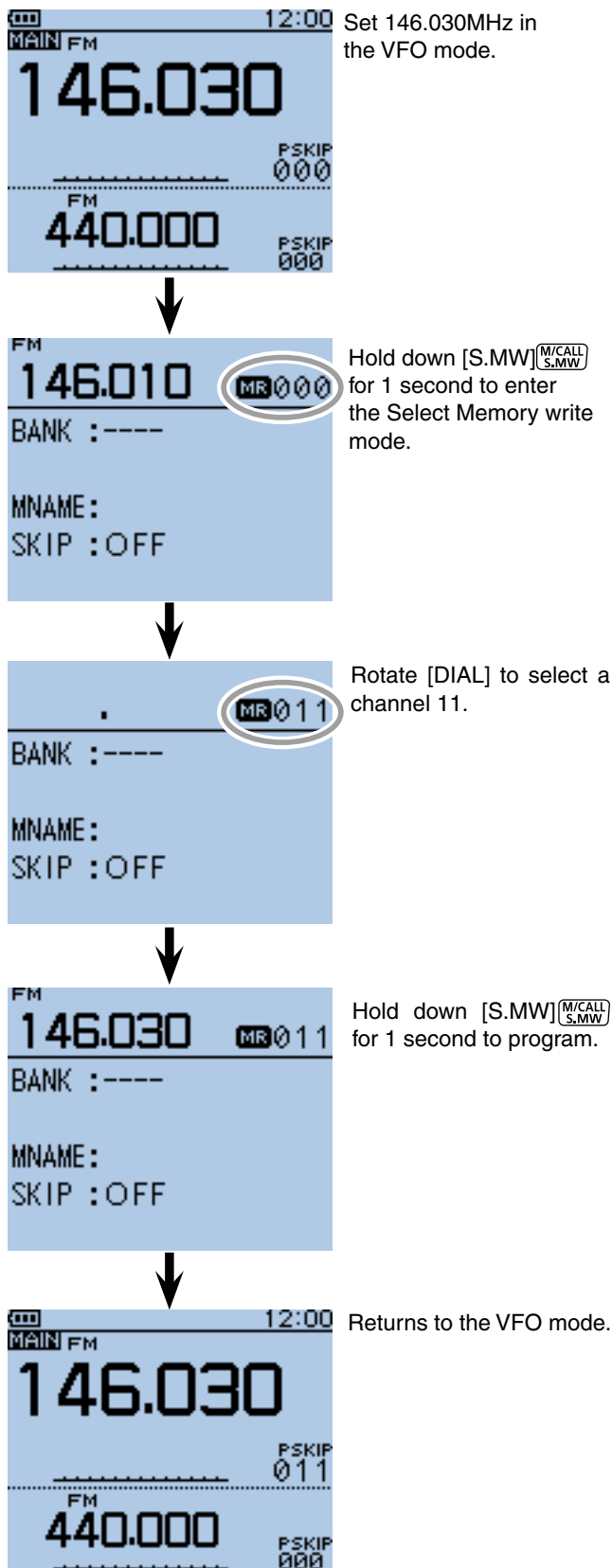

## ■ Copying memory and Call channel contents

This function copies a memory channel's contents to the VFO, another memory or Call channels. This is useful when searching for signals around a memory channel frequency, and for recalling the **frequency offset**, subaudible tone frequency and so on.

### ◇ Memory or Call channel⇒VFO

- ① Select the Memory or Call channel to be copied.
  - ➔ Push [M/CALL]<sup>[M/CALL S.MW]</sup> one or more times to select the Memory mode or the Call channel mode, then rotate [DIAL] to select a desired channel.
- ② Hold down [S.MW]<sup>[M/CALL S.MW]</sup> for 1 second to enter the Select Memory write mode, and copy the memory contents.
  - 1 short and 1 long beep sounds.
  - The memory channel number blinks.
- ③ Rotate [DIAL] to select "VFO."
- ④ Hold down [S.MW]<sup>[M/CALL S.MW]</sup> for 1 second to copy the selected channel contents to the VFO.
  - The transceiver automatically returns to the VFO.

**NOTE:** Holding down [S.MW]<sup>[M/CALL S.MW]</sup> for 2 seconds in step ② will also copy the memory contents to the VFO. In that case, steps ③ and ④ are not necessary.

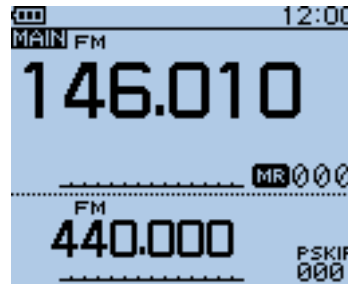
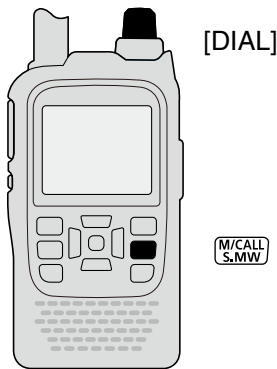

Select the memory or call channel to be copied.

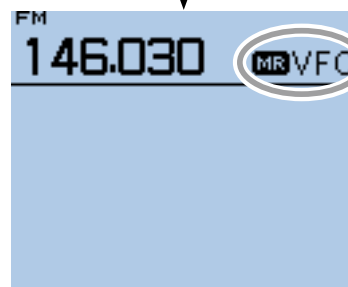

Hold down [S.MW]<sup>[M/CALL S.MW]</sup> for 1 second to enter the Select Memory write mode, and then, rotate [DIAL] to select "VFO."

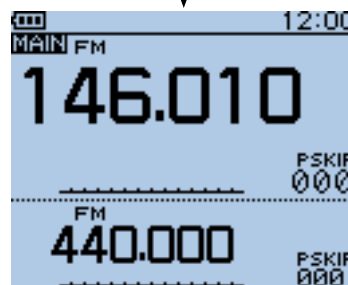

Hold down [S.MW]<sup>[M/CALL S.MW]</sup> for 1 second to copy. The selected channel contents appear in the VFO screen.

## ■ Copying memory and Call channel contents (Continued)

### ◇ Memory or Call channel → Another memory or Call channel

- ① Select the Memory or Call channel to be copied.
  - ➔ Push [M/CALL]<sup>[M/CALL S.MW]</sup> one or more times to select the Memory mode or the Call channel mode, then rotate [DIAL] to select a desired channel.
- ② Hold down [S.MW]<sup>[M/CALL S.MW]</sup> for 1 second to enter the Select Memory write mode.
  - 1 short and 1 long beep sounds.
  - The memory channel number blinks.
  - DO NOT hold down [S.MW]<sup>[M/CALL S.MW]</sup> for more than 2 seconds. If you do, the memory contents will be copied to the VFO.
- ③ Rotate [DIAL] to select the target Memory or Call channel.
 

Other channels shown below can be programmed:
- ④ Hold down [S.MW]<sup>[M/CALL S.MW]</sup> for 1 second again to copy.
  - 3 beeps sound.
  - The transceiver automatically selects the copied channel.

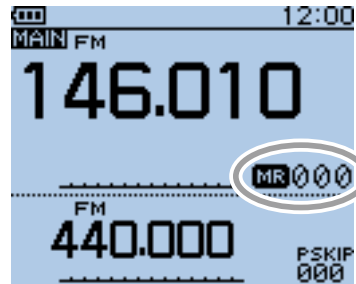

Select the memory channel to be copied.

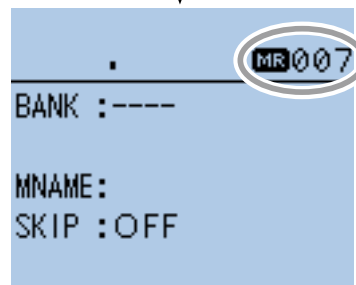

Hold down [S.MW]<sup>[M/CALL S.MW]</sup> for 1 second to enter the Select Memory write mode, and then, rotate [DIAL] to select the target channel.

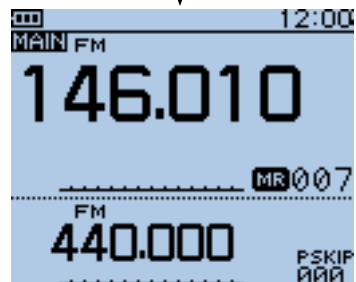

Hold down [S.MW]<sup>[M/CALL S.MW]</sup> for 1 second to copy. The copied channel is automatically selected.

## Memory bank setting

The ID-51A/E has a total of 26 banks (A to Z). Regular memory channels 0 to 499 are assigned to any desired bank for easy memory management. Up to 100 channels can be assigned to a bank.

### Assigning a memory channel to a memory bank

- ① Push [M/CALL]<sup>[M/CALL S.MW]</sup> one or more times to select the Memory mode, and then rotate [DIAL] to select a desired channel to be assigned to a bank.
- ② Hold down [S.MW]<sup>[M/CALL S.MW]</sup> for 1 second to enter the Select Memory write mode.
  - 1 short and 1 long beep sounds.
  - The memory channel number blinks.
  - DO NOT hold down [S.MW]<sup>[M/CALL S.MW]</sup> for more than 2 seconds. Otherwise the memory contents will be copied to the VFO.
- ③ Push [QUICK]<sup>[QUICK SPCH]</sup> to open the Quick Menu screen.
- ④ Push D-pad(↑) to select “Edit,” and then push D-pad(Ent) to enter the Memory bank edit mode.
- ⑤ Push D-pad(1) to select “BANK,” and then push D-pad(Ent).
  - “----” appears, then the first digit blinks.
  - If the selected memory channel has already been assigned to a bank, the Bank group and the bank channel number are displayed.
  - If the Bank name has already been programmed, it is also displayed.
- ⑥ Rotate [DIAL] to select a desired bank group, “A” to “Z.”
- ⑦ Push D-pad(→) to select the bank channel digit.
- ⑧ Rotate [DIAL] to select a desired bank channel number between “00” and “99.”
  - The bank channels are not displayed when the memory channel is already assigned.
  - Push D-pad(↔) to change the bank group or bank channel number selection.
- ⑨ Push D-pad(Ent) to set, and exit the Memory bank edit mode.
- ⑩ Push D-pad(↓) to select “<<Write>>,” and then push D-pad(Ent).
  - The confirmation screen “Overwrite?” appears.
- ⑪ Push D-pad(1) to select “YES,” and then push D-pad(Ent).
  - The selected memory channel is updated and assigned to the bank, and then the transceiver returns to the Memory mode.

**NOTE:** The memory banks are only used to hold memory channels. Thus if the original memory channel contents have been changed, the memory bank contents are also changed at the same time.

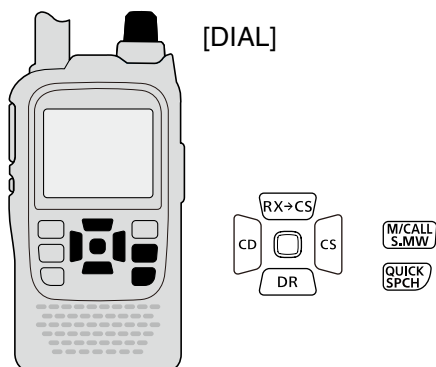
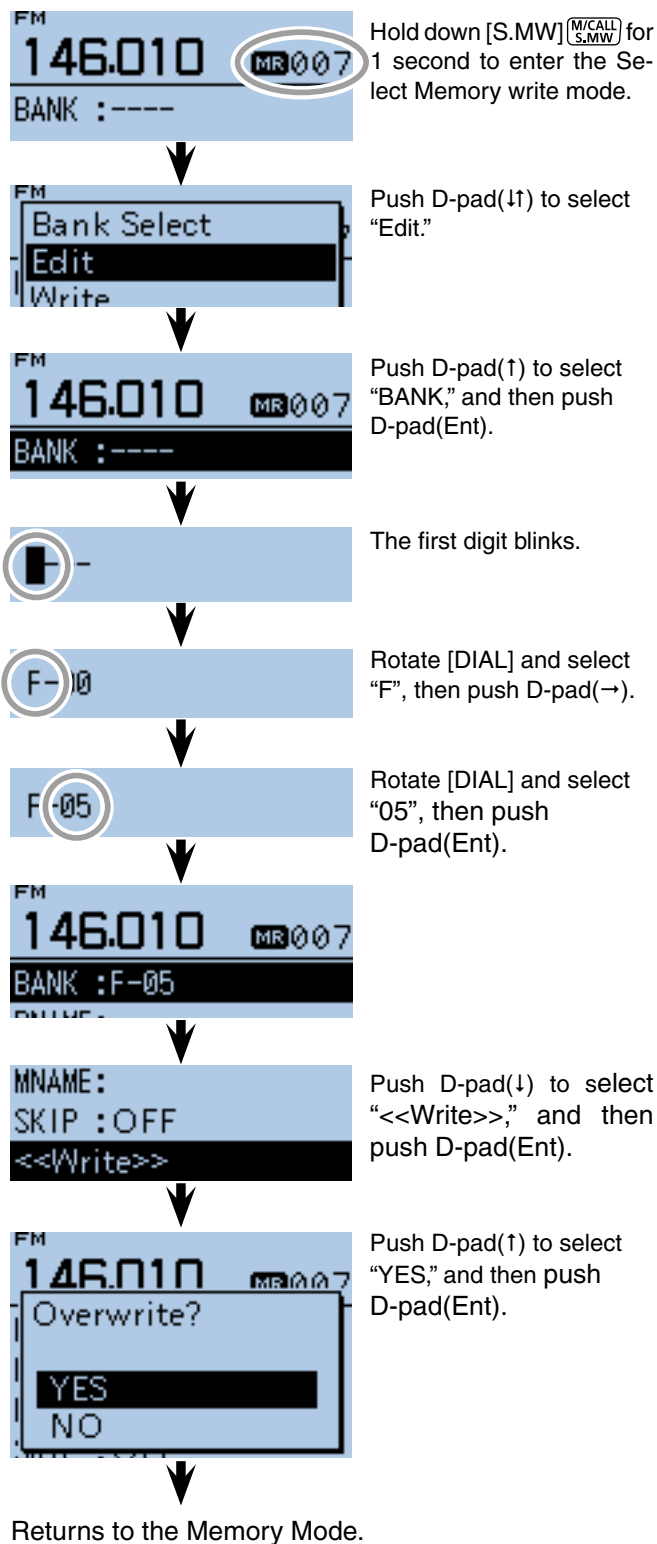

## Memory bank setting (Continued)

### Directly programming into a memory bank

You can also program the memory contents directly into a memory bank channel. This way is a short cut to programming the memory channel, and then assigning it to a bank. In that case, the transceiver automatically selects the lowest blank memory channel, to program.

- ① Push [V/MHz]<sup>(V/MHz)</sup><sub>(CLR/LOW)</sub> to select the VFO mode.
  - ② Set a desired frequency and operating mode:
    - Rotate [DIAL] to set a desired frequency. (Example: 146.010 MHz)
    - Push [MODE]<sup>(MODE)</sup><sub>(SCAN)</sub> one or more times to select a desired operating mode. (Example: FM mode)
    - Set duplex direction, frequency offset, tone squelch and so on, if desired.
  - ③ Hold down [S.MW]<sup>(M/CALL)</sup><sub>(S.MW)</sub> for 1 second to enter the Select Memory write mode.
    - 1 short and 1 long beep sound.
    - The memory channel number blinks, and memory contents are displayed.
  - ④ Push [QUICK]<sup>(QUICK)</sup><sub>(SPCH)</sub> to open the Quick Menu screen.
  - ⑤ Push D-pad(↑) to select "Bank Select," and then push D-pad(Ent).
- 
- ⑥ Rotate [DIAL] to select a desired bank group, "A" to "Z," and then push D-pad(Ent). (Example: "J")
    - If you want to change the bank group after pushing D-pad(Ent), return to step ④.
  - ⑦ Rotate [DIAL] to select a desired bank channel between "00" and "99." (Example: "01")
    - The bank channel number blinks.
    - If the selected bank channel is already assigned, the memory contents are displayed.
  - ⑧ Hold down [S.MW]<sup>(M/CALL)</sup><sub>(S.MW)</sub> for 1 second to program, and then return to the VFO mode.
    - 3 beeps sound.
    - If an already assigned bank channel is selected in step ⑦, the memory contents will be overwritten into the memory channel and bank channel.
    - The Bank channel number automatically increases when continuing to hold down [S.MW]<sup>(M/CALL)</sup><sub>(S.MW)</sub> after programming.

**NOTE:** Push [CLR]<sup>(V/MHz)</sup><sub>(CLR/LOW)</sub> to cancel the program and exit the Select Memory write mode before memory programming.

**NOTE:** If the Memory bank display is already selected and you want to program the contents into the memory channel, do the following steps:

- ① Select "ALL CH Select" in step ⑤.
- ② Rotate [DIAL] to select a desired memory channel.
- ③ Hold down [S.MW]<sup>(M/CALL)</sup><sub>(S.MW)</sub> for 1 second to program.

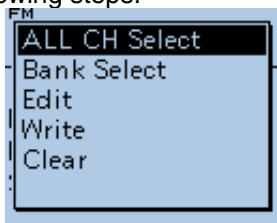

Example: Programming 146.010 MHz/FM mode into Memory bank channel J-01.

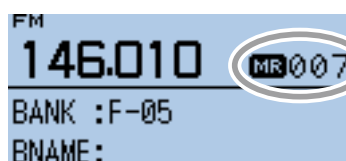

Hold down [S.MW]<sup>(M/CALL)</sup><sub>(S.MW)</sub> for 1 second to enter the Select Memory write mode.

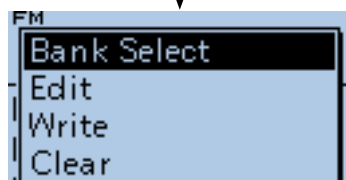

Push D-pad(↑) to select "Bank Select."

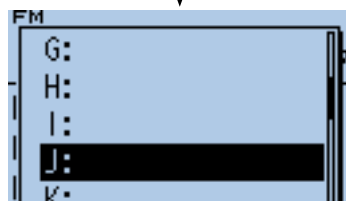

Rotate [DIAL] to select the bank group, "J."

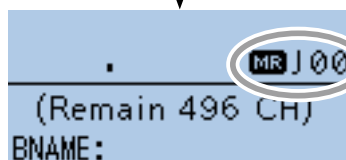

The bank channel number blinks.

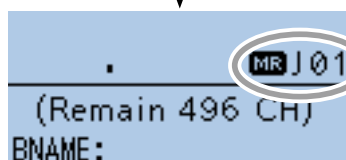

Rotate [DIAL] to select the bank channel "01."

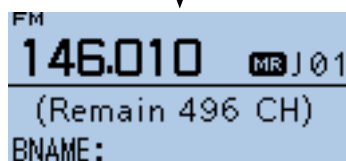

Hold down [S.MW]<sup>(M/CALL)</sup><sub>(S.MW)</sub> for 1 second to program.

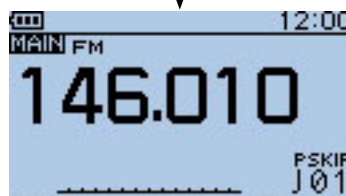

Returns to the VFO mode.

## Memory bank selection

- ① Push [M/CALL]<sup>[M/CALL S.MW]</sup> one or more times to select the Memory mode.
- ② Push [QUICK]<sup>[QUICK SPCH]</sup> to open the Quick Menu screen.
- ③ Push D-pad(↑) to select "Bank Select," and then push D-pad(Ent).

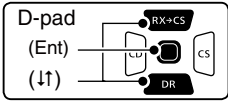

- ④ Rotate [DIAL] to select a desired bank group, "A" to "Z."
  - Only Bank groups that have memory channels assigned to them are displayed.
- ⑤ Push D-pad(Ent) to set.
- ⑥ Rotate [DIAL] to select a desired bank channel.
  - Only assigned bank channels are displayed.
  - To return to the Memory channels display, repeat steps ② to ③, and select "OFF" in step ④.

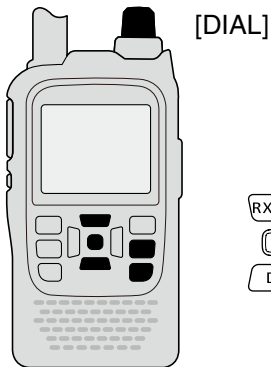

Example: Selecting the bank group "A."

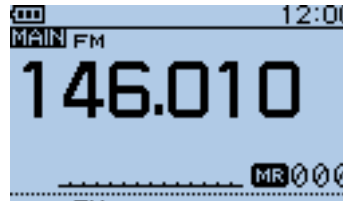

Push [M/CALL]<sup>[M/CALL S.MW]</sup> one or more times to select the Memory mode.

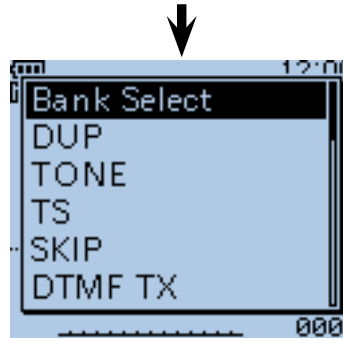

Push [QUICK]<sup>[QUICK SPCH]</sup>, then push D-pad(↑) to select "Bank Select."

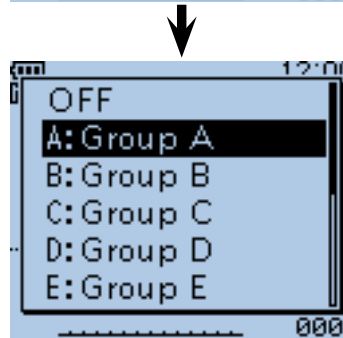

Rotate [DIAL] to select the bank group "A."

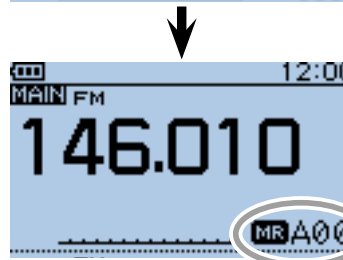

Push D-pad(Ent) to set.

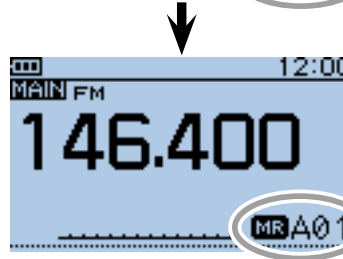

Rotate [DIAL] to select a desired bank channel.



## ■ Programming memory/bank/scan name

Each memory channel can be programmed with an alphanumeric channel name for easy recognition. Names can be a maximum of 16 characters.

**NOTE:** Only one name can be programmed for each bank. Therefore, the previously programmed bank name will be displayed when bank name is selected. Also, the bank names are automatically updated in other memory channels assigned to the same bank group.

### ◇ Programming memory name, bank name or scan name

- ① Hold down [S.MW]<sup>[M/CALL S.MW]</sup> for 1 second to enter the Select Memory write mode.
  - 1 short and 1 long beep sounds.
  - The memory channel number blinks.
  - DO NOT hold down [S.MW]<sup>[M/CALL S.MW]</sup> for more than 2 seconds.
- ② Rotate [DIAL] to select a desired memory channel.
  - Select Call channels (C0 to C3) to program a Call channel name, or Scan edge channels (0A/0B to 24A/24B) to program a scan name.
- ③ Push [QUICK]<sup>[QUICK SPCH]</sup> to open the Quick Menu screen.
- ④ Push D-pad(↑) to select “Edit,” and then push D-pad(Ent) to enter the name programming mode.

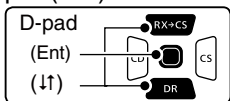

- ⑤ Push D-pad(↑) to select “MNAME,” “BNAME” or “SNAME,” and then push D-pad(Ent).
  - MNAME” is for a memory name, “BNAME” for a bank name or “SNAME” for a scan name.
  - If the selected memory channel’s name has already been programmed, the name is displayed.
  - “BNAME” appears only when the selected memory channel is assigned to a bank.
  - “SNAME” appears only when the selected memory channel is a scan edge channel. The same name is automatically assigned to both scan edge channels, A and B.
  - After pushing D-pad(Ent), the cursor blinks on the first digit.

**NOTE:** When entering the scan type selection mode, the programmed Scan name is displayed instead of the frequency range indication.

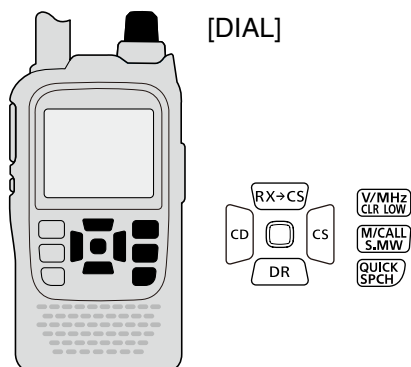

Example: Programming the memory name “ID-51” in M-CH000.



In the Select Memory Write mode, select M-CH000, and then push [QUICK]<sup>[QUICK SPCH]</sup>.

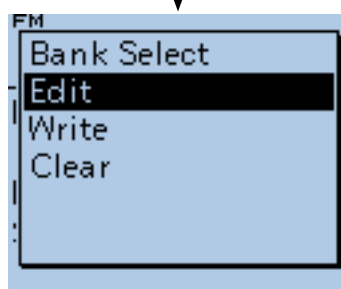

Push D-pad(↑) to select “Edit,” and then push D-pad(Ent).



Push D-pad(↑) to select “MNAME.”

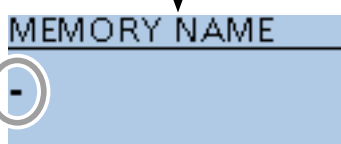

The cursor blinks on the first digit.

Continued on the next page



## 12 MEMORY CHANNEL PROGRAMMING

### ■ Programming memory/bank/scan name

#### ◇ Programming memory name, bank name or scan name (Continued)

##### ⑥ Rotate [DIAL] to select a desired character.

- Selectable input characters are Upper case letters, Lower case letters, Numbers or Symbols.
- The selected character blinks.
- Push D-pad(←) to move the cursor backward or forward.
- While selecting a character, push [QUICK] <sup>QUICK</sup> <sub>SPCH</sub> to change the character to an upper case or lower case letter.
- While selecting a digit, push [QUICK] <sup>QUICK</sup> <sub>SPCH</sub> to open the input mode selection window.

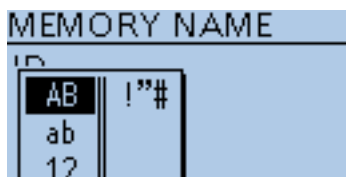

- A space can be entered in any input mode selected.
- Rotate [DIAL] counter clockwise to enter a space.
- Push [CLR] <sup>V/MHZ</sup> <sub>CLR LOW</sub> to delete the selected character, or hold down [CLR] <sup>V/MHZ</sup> <sub>CLR LOW</sub> to continuously delete the characters, first to the right, and then to the left of the cursor.
- See page 2-7 for programming details.

##### ⑦ Push D-pad(→) to move the cursor to the second digit.

##### ⑧ Repeat steps ⑥ and ⑦ to enter the desired channel name of up to 16 characters.

##### ⑨ Push D-pad(Ent) to save, and exit the Memory name edit mode.

##### ⑩ Push D-pad(↓) to select "<<Write>>," and then push D-pad(Ent).

- The confirmation screen "Overwrite?" appears.

##### ⑪ Push D-pad(↑) to select "YES," and then push D-pad(Ent).

- Returns to the screen viewed before entering the Select Memory write mode in step ②.

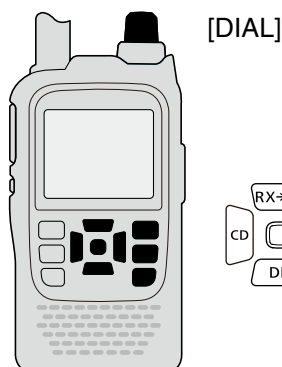

Continued from the previous page

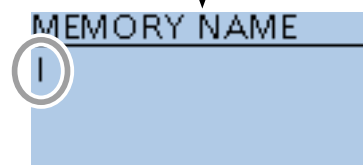

Rotate [DIAL] to select "I". Push D-pad(→) to move the cursor to the second digit.

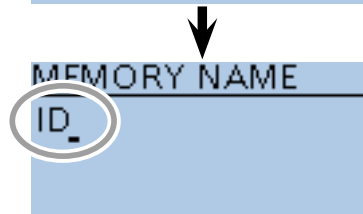

Rotate [DIAL] to select "D".

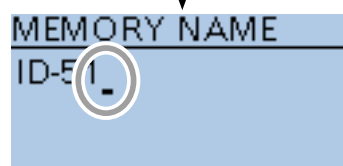

Repeat steps ⑥ and ⑦ until the desired memory name is programmed.

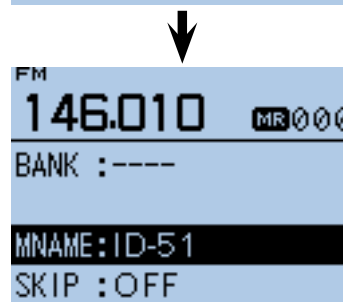

Push D-pad(Ent) to save the name and exit the Memory name edit mode.

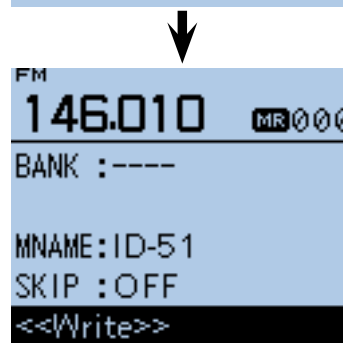

Push D-pad(↓) to select "<<Write>>," and then push D-pad(Ent.)

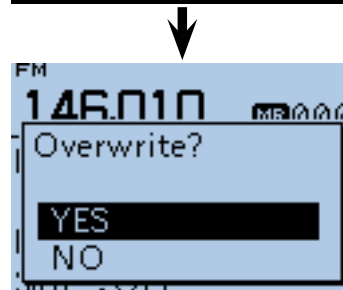

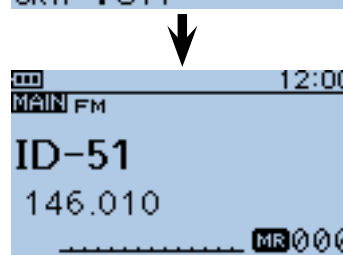

Push D-pad(↑) to select "YES," and then push D-pad(Ent).



Returns to the screen viewed before entering the Select Memory write mode. Memory name is displayed.

## ■ Selecting a memory name display

While in the memory mode, the programmed memory name can be displayed.

- ① Push [M/CALL]  one or more times to select the Memory mode.
- ② Push [QUICK]  to open the Quick Menu screen.
- ③ Push D-pad(↑) to select "Display Type," and then push D-pad(Ent).

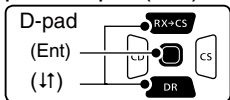

- ④ Rotate [DIAL] to select a desired Display type, and then push D-pad(Ent).
  - Freq (Name OFF) : Displays only the frequency.
  - Freq : Displays the large font sized frequency and small font sized memory name.
  - Name : Displays large font sized memory name and a small font sized frequency.

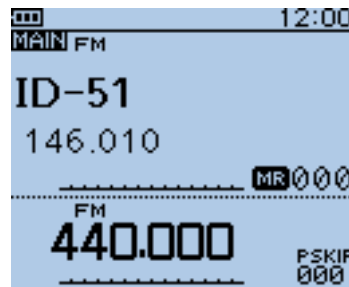

Push [QUICK] .

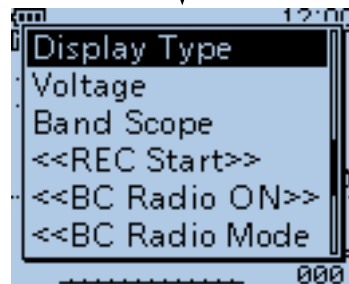

Push D-pad(↑) to select "Display Type," and then push D-pad(Ent).



Push D-pad(↑) to select a desired Display type, and then push D-pad(Ent).

Example: When Memory Name "ID-51" is programmed into M-CH 000 (146.010MHz).

• Freq (Name OFF)

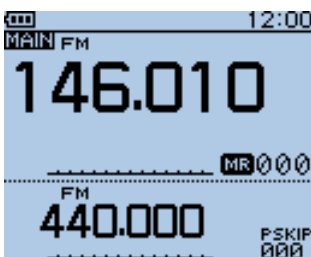

• Freq

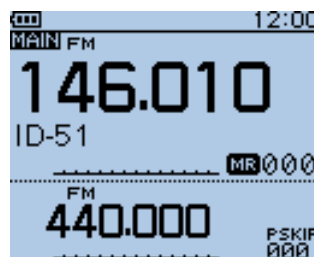

• Name

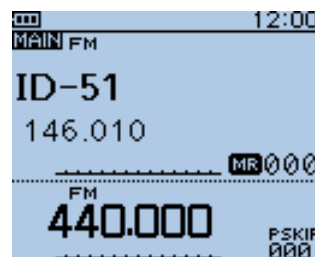

## Memory clearing

Contents of programmed memories can be cleared (erased), if desired.

- ① Hold down [S.MW]<sup>[M/CALL S.MW]</sup> for 1 second to enter the Select Memory write mode.
  - 1 short and 1 long beep sounds.
  - The memory channel number blinks.
  - DO NOT hold down [S.MW]<sup>[M/CALL S.MW]</sup> for more than 2 seconds.
- ② Rotate [DIAL] to select a desired memory channel to be cleared.
  - Select Call channels (C0 to C3) to erase a call channel, or scan edge channels (0A/0B to 24A/24B) to erase a scan channel.
- ③ Push [QUICK]<sup>[QUICK SPCH]</sup> to open the Quick Menu screen.
- ④ Push D-pad(↓) to select “Clear,” and then push D-pad(Ent).
  - The confirmation screen “Clear?” appears.
- ⑤ Push D-pad(↑) to select “YES,” and then push D-pad(Ent) to clear the contents.
  - After clearing, the display returns to the Select Memory write mode.
  - To cancel the memory clearing, select “NO” and push D-pad(Ent.).
- ⑥ Push [CLR]<sup>[V/MHZ CLR LOW]</sup> to exit the Select Memory write mode.
  - Returns to the previous screen viewed before entering the Select Memory write mode in step ①.

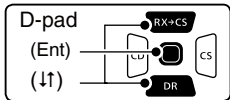

[DIAL]

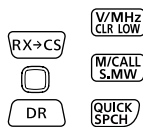

Example: Clearing the memory channel 007.



In the Select Memory write mode, rotate [DIAL] to select the memory channel to be cleared.

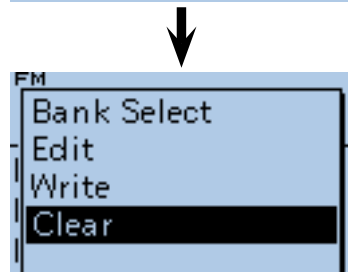

Push [QUICK]<sup>[QUICK SPCH]</sup>, and push D-pad(↓) to select “Clear,” then push D-pad(Ent).

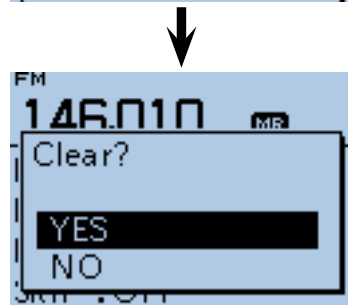

Push D-pad(↑) to select “YES,” and then push D-pad(Ent) to clear.

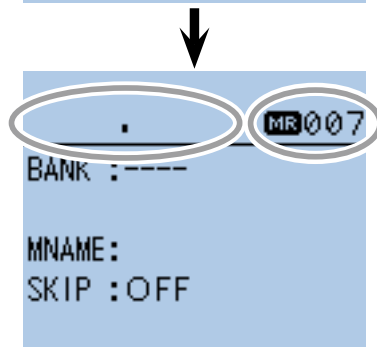

Returns to the Select Memory write mode.

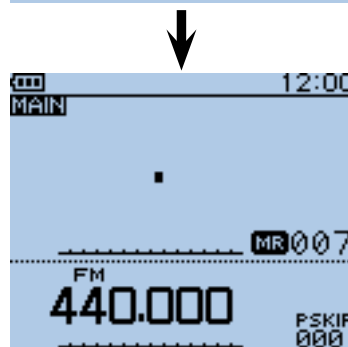

Push [CLR]<sup>[V/MHZ CLR LOW]</sup> to return to the screen viewed before entering the Select Memory write mode.

# Section 13 SCAN OPERATION

---

- Scan ..... 13-2
  - ◇ About the scan function..... 13-2
  - ◇ VFO scan ..... 13-2
  - ◇ Memory scan..... 13-2
  - ◇ Memory bank scan..... 13-2
  - ◇ Scanning direction..... 13-3
  - ◇ Squelch setting for a scan ..... 13-3
  - ◇ Tuning step for a VFO scan ..... 13-3
  - ◇ Skip function..... 13-3
  - ◇ Temporarily Skip timer..... 13-3
  - ◇ Receive mode for a scan..... 13-3
  - ◇ When a signal is received ..... 13-4
  - ◇ Scan name ..... 13-4
  - ◇ Scan Stop Beep function..... 13-4
  - ◇ Scan function during Dualwatch operation.... 13-4
- VFO scan ..... 13-5
  - ◇ VFO mode scan ..... 13-5
- Setting and clearing the skip frequencies..... 13-7
  - ◇ Setting the skip frequencies ..... 13-7
  - ◇ Clearing the skip setting ..... 13-8
- Memory scan..... 13-9
  - ◇ Memory (skip) scan..... 13-9
  - ◇ Memory bank scan..... 13-10
- Setting the skip channel ..... 13-12
- Setting the temporary skip function ..... 13-13

## Scan

Scanning is a versatile function that can automatically search for signals and makes it easier to locate stations to contact or listen to, or to skip unwanted channels or frequencies.

### ◇ About the scan function

#### • In the VFO mode

The frequencies that are set as “PSKIP” are skipped during a scan. (p. 13-7)

**NOTE:** One or more pair of the scan edge channels must be programmed to start a program scan.

#### • In the memory mode

Repeatedly scans all programmed Memory channels. The frequencies that are set as skip channels “PSKIP” and “SKIP” are not scanned. (p.13-12)

**NOTE:** Two or more memory channels must be programmed to start a memory scan.

#### [Duplex (DUP) scan]

The Duplex scan searches for both TX and RX frequencies which are used in duplex operation. (p. 15-4, 15-5)

- The “DUP-” or “DUP+” icon is displayed in the duplex mode.
- A duplex scan will not start when the **frequency offset** is set to “0.000 MHz.”

#### [Tone scan]

The tone scan searches for tone frequencies or DTCS codes that are used by stations using the **Squelch** function.

- A tone scan can be made in any mode: VFO, memory or Call channel.
- During a tone scan, rotate [DIAL] to switch scan direction.

Refer to “**Tone Squelch function**” or “**DTCS code Squelch function**” for details. (pp. 17-13 to 17-16)

### ◇ VFO scan

- **ALL** (Full scan) p. 13-5

Repeatedly scans the entire band.

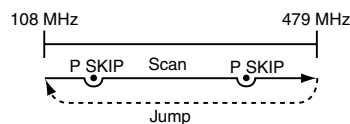

- **BAND** (Selected band scan) p. 13-5

Scans all frequencies over the entire selected band.

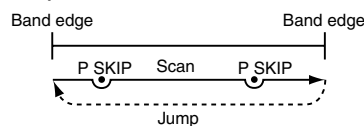

- **PROG 0-24** (Program scan) p. 13-5

Scans the frequency range which is programmed into the program scan channels (PROGRAM-CH).

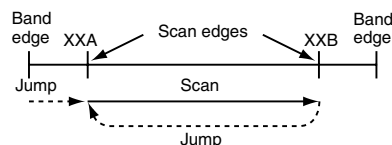

- **P-LINK0-9** (Program link scan) p. 13-5

Sequentially scans the program scan channels which are set to link in the “PROGRAM LINK” item in the MENU screen. (p. 16-20)  
(MENU > Scan > **Program Link**)

### ◇ Memory scan

- **ALL** (Memory full scan) p. 13-9

Scans all memory channels.

- **BAND** (Selected band memory scan) p. 13-9

Scans all Memory channels on the same frequency band as the selected channel.

- **MODE** (Mode memory scan) p. 13-9

Scans memory channels which are programmed with the same receiving mode as the currently selected mode.

### ◇ Memory bank scan

- **ALL** (Full bank scan) p. 13-10

Scans all banks.

- **BANK-LINK** (Bank link scan) p. 13-10

Sequentially scans the banks which are set to link in the “BANK LINK” item in the MENU screen.  
(MENU > Scan > **Bank Link**)

- **BANK-A-Z** (Bank scan) p. 13-10

Scans the memory channels in the selected bank.

## 13 SCAN OPERATION

### ■ Scan (Continued)

#### ◇ Scanning direction

- If desired, rotate [DIAL] to switch the scanning direction during a scan.

#### ◇ Squelch setting for a scan

The squelch level can be changed to suit your operating needs. Set the squelch level to open the squelch, according to the received signal strength.

The default squelch level is "AUTO."

- During a scan, while holding down [SQL], and then rotate [DIAL] to adjust the squelch level. Release [SQL] to restart the scan.

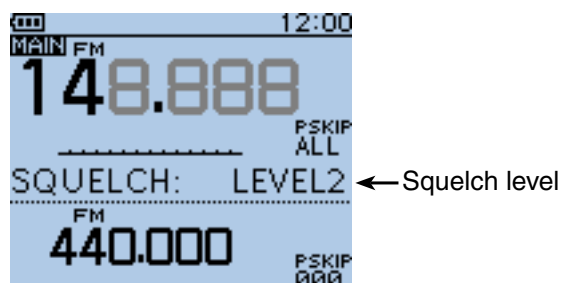

#### ◇ Tuning step for a VFO scan

The selected tuning step is applied to the scan.

#### ◇ Skip function

The skip function speeds up scanning by not scanning those frequencies set as skip channels.

When the "PROGRAM SKIP" item is set to OFF, the Scan Skip function cannot be used. (p. 16-19)  
(MENU > Scan > **Program skip**)

#### ◇ Temporary Skip timer

The Temporary Skip function temporarily skips unwanted frequencies during a scan, for the set period.

- These settings can be changed in the MENU screen. (p. 16-18)

(MENU > Scan > **Temporary Skip Timer**)

#### ◇ Receive mode for a scan

- The selected receive mode is used by the scan.
- During a memory or bank scan, the receive mode programmed into the channel is used by the scan.

Scanning in the FM mode

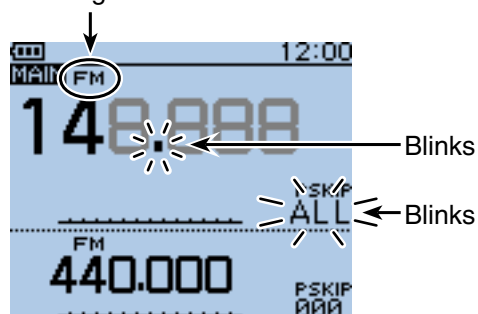

■ Scan (Continued)

◇ When a signal is received

When a signal is received, the scan pauses for approximately 10 seconds (default), then resumes.

The scan resumes approximately 2 seconds (default) after the signal is disappears.

To manually resume the scan, rotate [DIAL].

• These settings can be changed in the MENU screen.  
(p. 16-18)

(MENU > Scan > **Pause Timer**)

(MENU > Scan > **Resume Timer**)

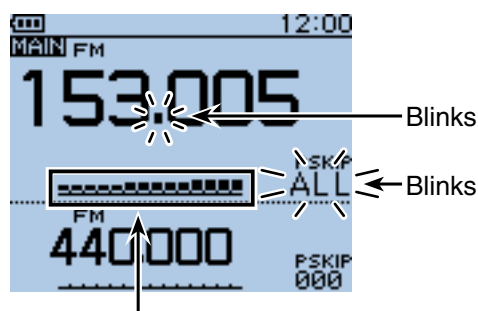

The S-meter shows the received signal strength.

◇ Scan name

A desired name can be assigned to each PROGRAM-CH (\*\*A/\*\*B). (p. 12-10)

By selecting the scan name, the scanning frequency range will be set.

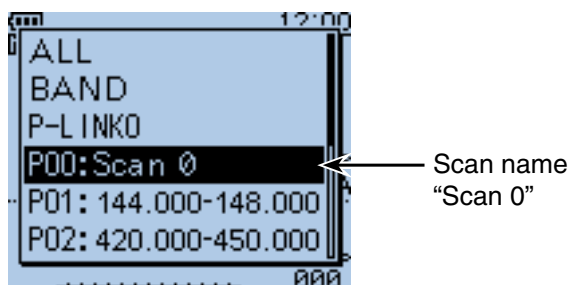

The scan type selecting screen.

◇ Scan Stop Beep function

The Scan Stop Beep function sounds a beep when a signal is received.

The function can be turned ON in the MENU screen.  
(p. 16-80)

(MENU > Sounds > **Scan Stop Beep**)

◇ Scan function during Dualwatch operation

When the scan function is used during the dualwatch operation, the SUB band audio signal may be muted, depending on the operating band or mode.

And, the audio output may be interrupted when the frequency or operating mode is switched while scanning.

○ SUB band mute status

MAIN band	SUB band
DV mode	DV mode
	FM-N mode
FM-N mode	DV mode
	FM-N mode
AIR band	AIR band

Example: Full scan is running on the MAIN band, and the AIR band is selected on the SUB band.

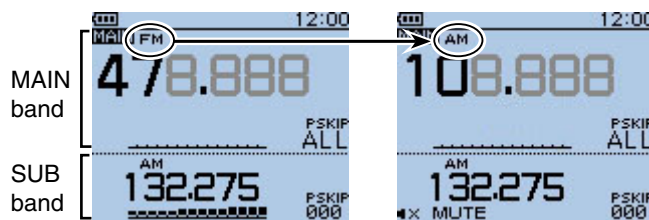

When an AIR band frequency is scanned on the MAIN band, the SUB band audio signal is muted.

## ■ VFO scan

There are 6 scan types: Full scan, Band scan, Program scan, Program link scan, Duplex scan and Tone scan.

### NOTE:

The frequencies that are set as skip channels "PSKIP" are skipped during a scan.

When the "PROGRAM SKIP" item in the MENU screen is set to OFF, the frequencies that are set as skip channels "PSKIP", are not skipped during a scan.

(MENU > Scan > Program Skip)

### ◇ VFO mode scan

- ① Push [V/MHz] to select the VFO mode.
- ② Push [MODE] to select the operating mode.
- ③ Hold down [SCAN] for 1 second.
- ④ Push D-pad(↑) to select the scan type.
  - ALL : Full scan.
  - BAND : Band scan.
  - P-LINK0-9 : Program link scan.
  - P00-24 : Program scan.
  - DUP : Duplex scan (p. 13-2).  
(Appears only when duplex is set.)
  - TONE : Tone scan.  
(For tone squelch scanning)

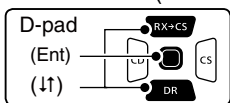

- ⑤ Push D-pad(Ent) to start the scan.
  - ALL : The decimal point and "ALL" blinks.
  - BAND: The decimal point and "BND" blinks.
  - P-LINK0-9/P00-24 : The decimal point and Scan edge number blink.
  - DUP : The decimal point and "DUP+/" "DUP-" blink.
  - If desired, rotate [DIAL] to switch the scanning direction during a scan.
  - If desired, push [MODE] to change the operating mode during a scan.
  - The scan resumes even while the MENU screen is displayed.
- ⑥ To cancel the scan, hold down [SCAN] for 1 second.
  - Pushing [CLR] also cancels the scan.

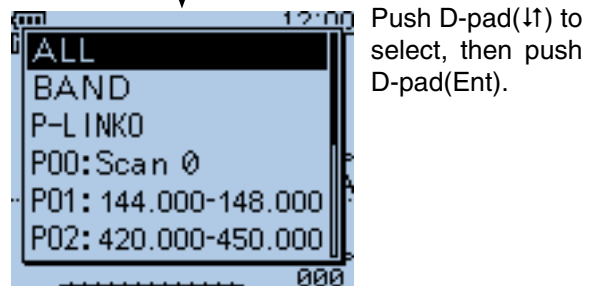
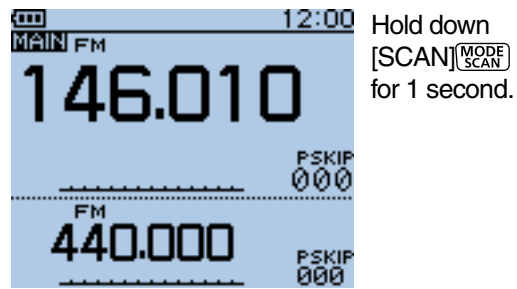
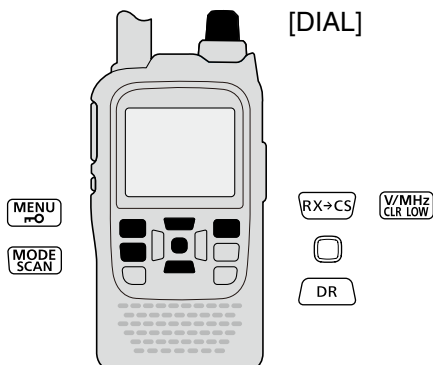

Example: Full scan in the FM mode.

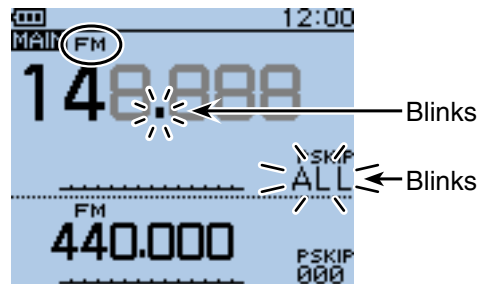

When a signal is received.

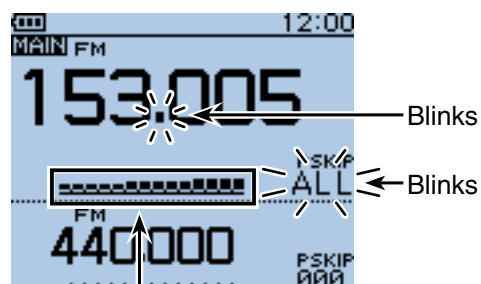

The S-meter shows the received signal strength.

### ✓ Convenient!

Holding down [SCAN] and rotate [DIAL] also selects the scan type. The scan immediately starts when [SCAN] is released.



# 13 SCAN OPERATION

◇ VFO mode scan (continued)

### When a scan name is assigned.

When a scan name is assigned, the scan type can be set by selecting the scan name from the scan type list. (Step ④ on page 13-5.)

/// **NOTE:** The scan name is not displayed during a scan.

### • When the scan name is assigned

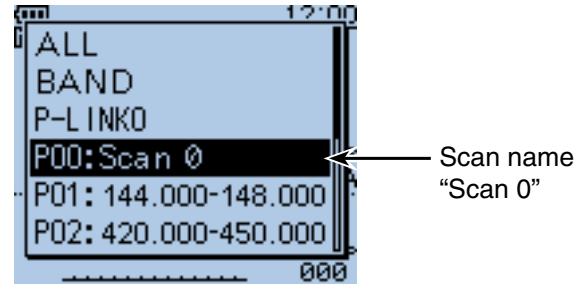

### • When the scan name is not assigned

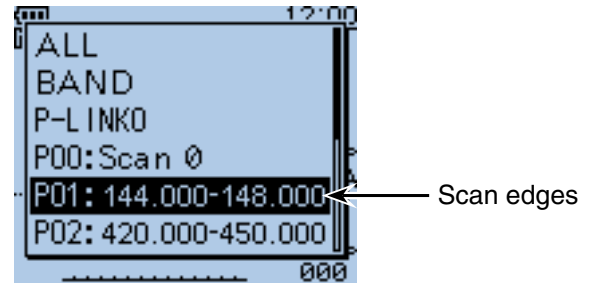

### When a program link name is assigned.

When a program link name is assigned, the scan type can be set by selecting the program link name from the scan type list. (Step ④ on page 13-5.)

/// **NOTE:** The program link name is not displayed during a scan.

### • When the program link name is assigned

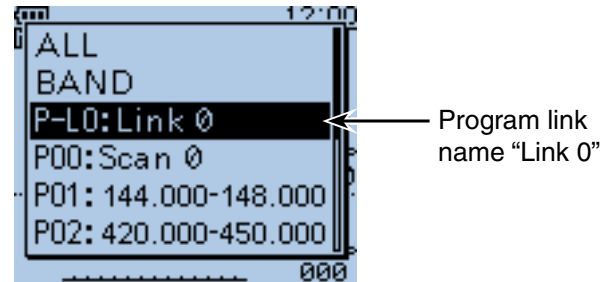

### • When the program link name is not assigned

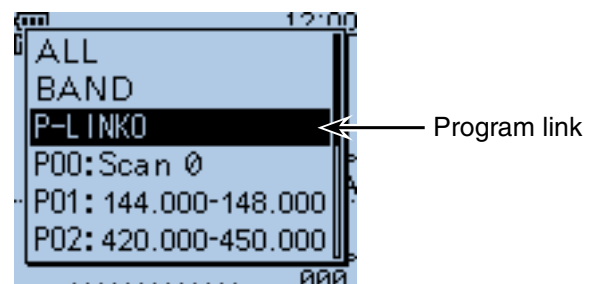

## ■ Setting and clearing the skip frequencies

### ◇ Setting the skip frequencies

The frequencies set as skip channels "PSKIP" are skipped (not scanned).

- ① Start the VFO scan (p. 13-5).
  - When a signal is received, the scan pauses.
- ② While the scan is paused, and if you want to skip the frequency, hold down [S.MW] <sup>[M/CALL]</sup><sub>[S.MW]</sub> for 1 second (until the 3 beeps sound).
  - The memory channel number blinks.
  - When a signal is received during the scan, the transceiver attempts to program the frequency as a skip channel, into empty memory channel 499.
  - If channel 499 is already programmed, the transceiver automatically searches backwards for a blank channel to program. If no blank memory channel is found, a beep sounds, and no skip channel is programmed.
- ③ After the skip channel is programmed, or the beep sounds, the scan resumes.

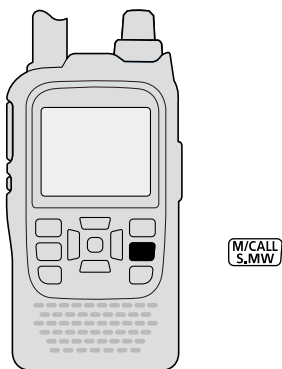

Example: Full scan in the FM mode.

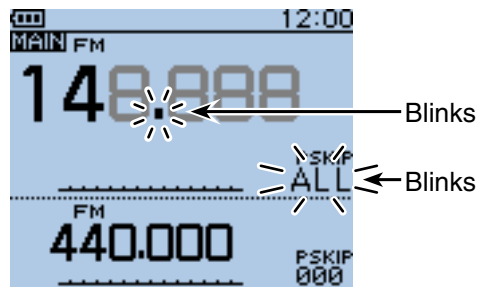

When a signal is received.

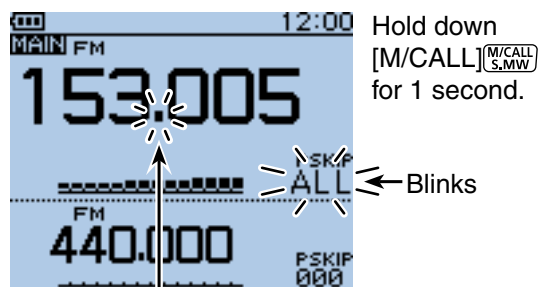

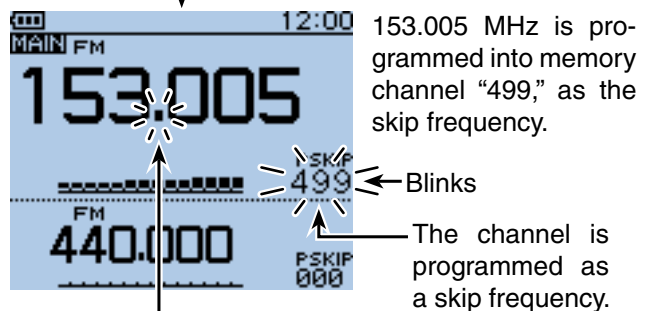

Blinks



Blinks

## ■ Setting and clearing the skip frequencies (Continued)

### ◇ Clearing the skip setting

- ① Push [M/CALL]  one or more times to select the Memory mode.
- ② Rotate [DIAL] to select the memory channel you want to clear as the skip channel.
- ③ Push [QUICK] .
- ④ Push D-pad(↑) to select "SKIP," and then push D-pad(Ent).

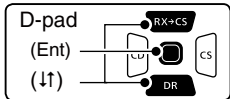

- ⑤ Push D-pad(↓) to select "OFF."
  - OFF : Cancel the skip setting.
  - SKIP : Skipped during a memory scan.
  - PSKIP : Skipped during both VFO and memory scans.
- ⑥ Push D-pad(Ent) to save the selection.
  - The skip setting is canceled.

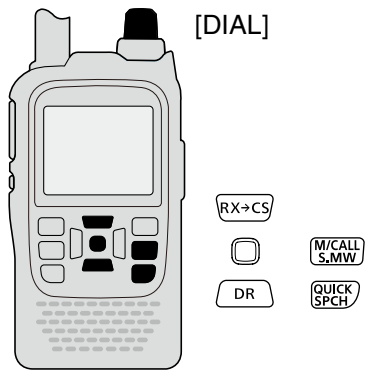

### ✓ Information

The skip setting is also cancelled when the memory channel set as skip channel is deleted.  
See page 12-13 for details.

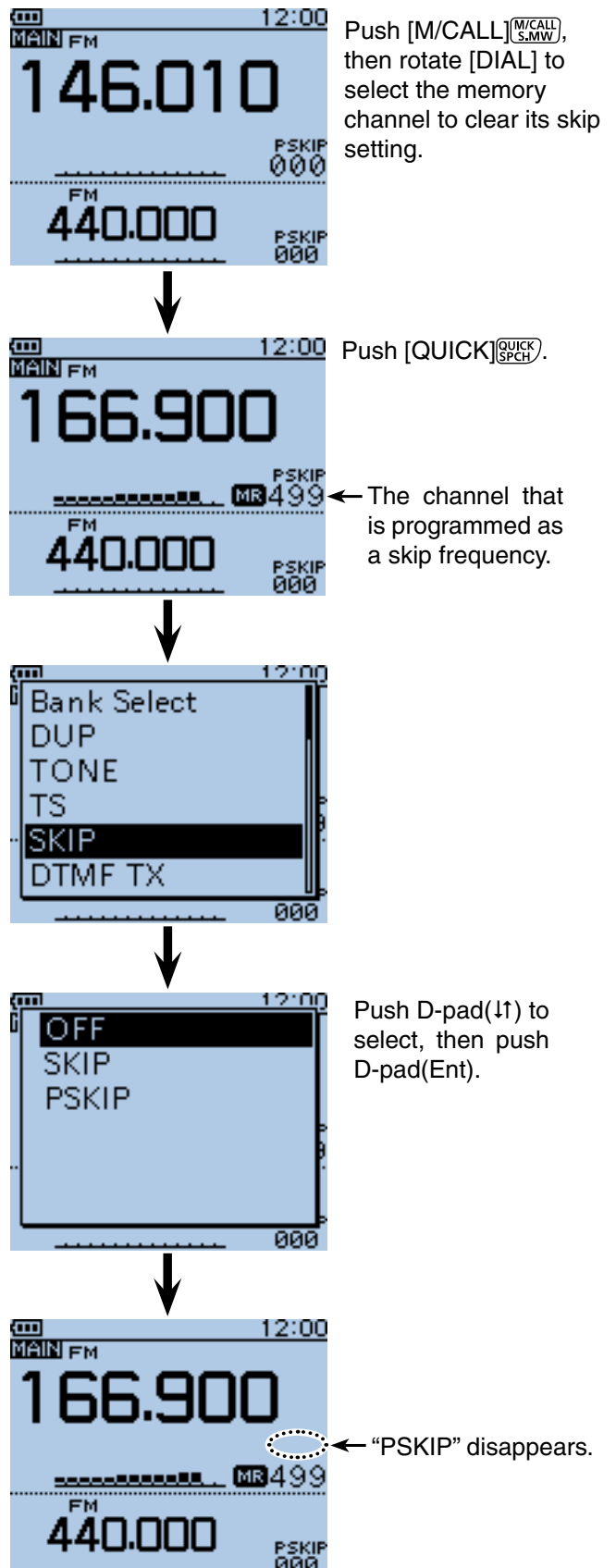

## Memory scan

Repeatedly scans all programmed Memory channels. There are two types of scan in the memory mode; Memory scan and memory bank scan.

- Channels set as “PSKIP” or “SKIP” are skipped during a scan.
- Two or more memory channels, which are not set as skip channels, must be programmed into start a memory scan.

### Memory (skip) scan

The memory channels set as “PSKIP” or “SKIP” skip channels are not scanned.

- 1 Push [M/CALL]<sup>(M/CALL S.MW)</sup> one or more times to select the Memory mode.
- 2 Hold down [SCAN]<sup>(MODE SCAN)</sup> for 1 second.
- 3 Push D-pad(↑) to select the scan type.
  - ALL : Full scan
  - BAND : Band memory scan
  - MODE : Mode memory scan
  - DUP : Duplex scan (p. 13-2)  
(Appears only when **duplex** is set on the channel.)
  - TONE : Tone scan (For tone scanning)

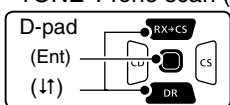

- 4 Push D-pad(Ent) to start the scan.
  - If desired, rotate [DIAL] to switch the scanning direction during a scan.
  - The scan resumes even while the MENU screen is displayed.
- 5 To cancel the scan, hold down [SCAN]<sup>(MODE SCAN)</sup> for 1 second.
  - Pushing [CLR]<sup>(V/MHz CLR LOW)</sup> also cancels the scan.

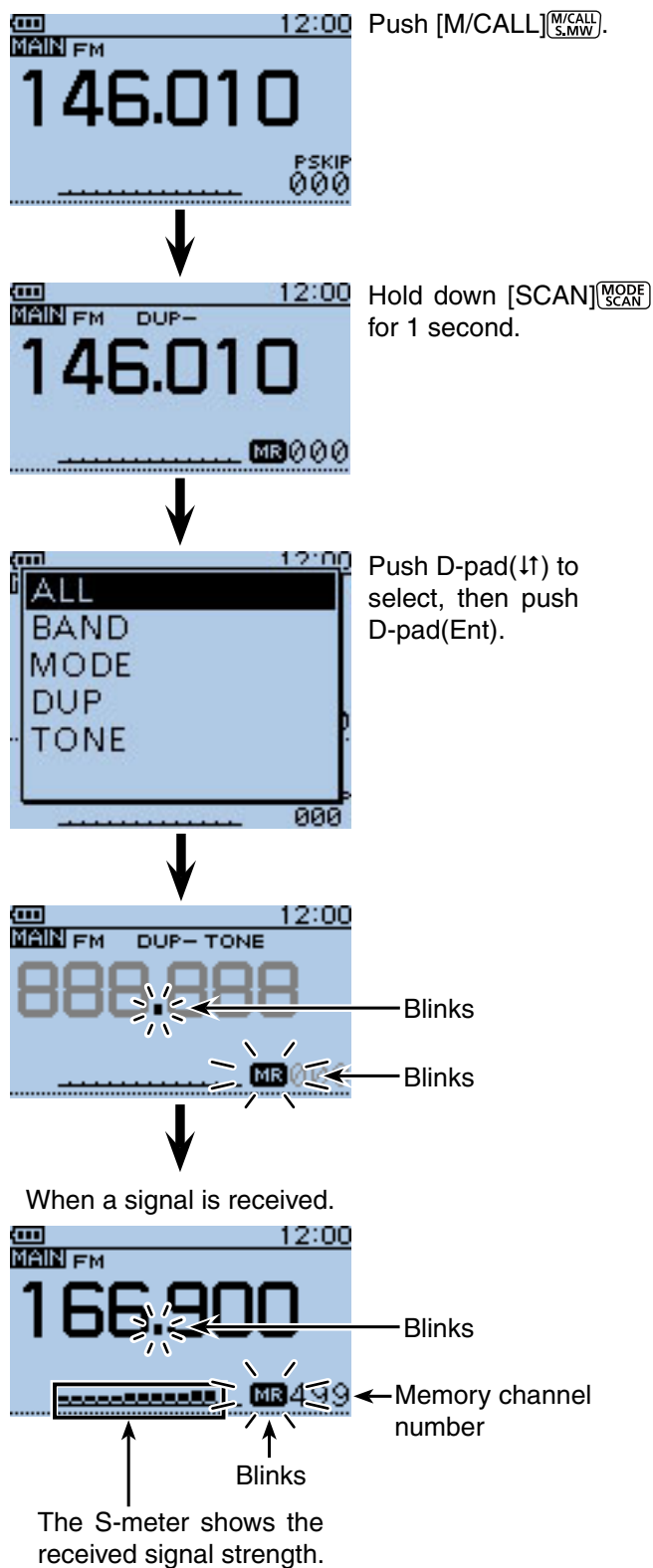
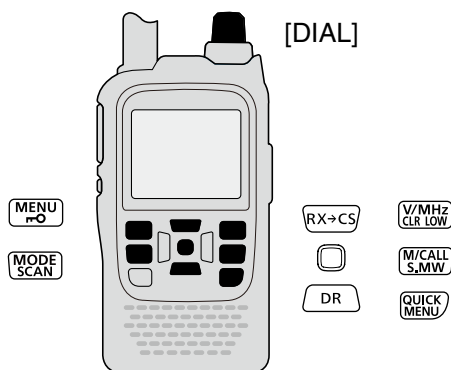

### ✓ Convenient!

Holding down [SCAN]<sup>(MODE SCAN)</sup> and then rotating [DIAL] also selects the scan type. The scan immediately starts when [SCAN]<sup>(MODE SCAN)</sup> is released.

# 13 SCAN OPERATION

## Memory scan (Continued)

### Memory bank scan

A memory bank scan searches through the memory channels in the selected bank.

- Two or more memory channels, which are not set as skip channels, must be programmed to start a memory bank scan.
- When the “BANK” item in the MENU screen is set to “OFF,” a bank scan is not started.

- ① Push [M/CALL] <sup>[M/CALL S.MWV]</sup> one or more times to select the Memory mode.
- ② Push [QUICK] <sup>[QUICK SPCH]</sup> to open the Quick Menu screen.
- ③ Push D-pad(↑) to select “Bank Select,” and then push D-pad(Ent).

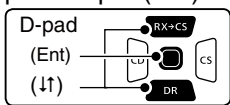

- ④ Rotate [DIAL] to select a desired bank group to be scanned, and then push D-pad(Ent).
  - Only Bank groups that have memory channels assigned to them are displayed.
- ⑤ Hold down [MODE] <sup>[MODE SCAN]</sup> for 1 second.
- ⑥ Push D-pad (↑) to select the scan type.
  - ALL : Full bank scan
  - BANK-LINK : Bank link scan
  - BANK-A to Z : Bank scan (Only banks which contain a memory channel are displayed.)
  - DUP : Duplex scan (p. 13-2) (Appears only when duplex is set on the channel.)
  - TONE : Tone scan (For tone scanning)
- ⑦ Push D-pad(Ent) to start the scan.
- ⑧ To cancel the scan, hold down [SCAN] <sup>[MODE SCAN]</sup> for 1 second.
  - Pushing [CLR] <sup>[V/MHz CLR LOW]</sup> also cancels the scan.

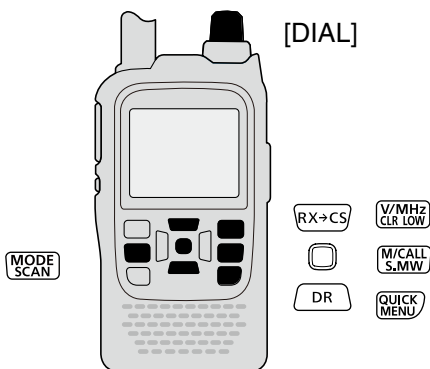

### ✓ Convenient!

Holding down [SCAN] <sup>[MODE SCAN]</sup> and rotate [DIAL] also selects the scan type. The scan immediately starts when [SCAN] <sup>[MODE SCAN]</sup> is released.

### NOTE:

- The bank contains only channels which are set as “SKIP” or “PSKIP” are skipped.
- When the all selected banks contain only channels which are set as “SKIP” or “PSKIP,” the scan is not started.

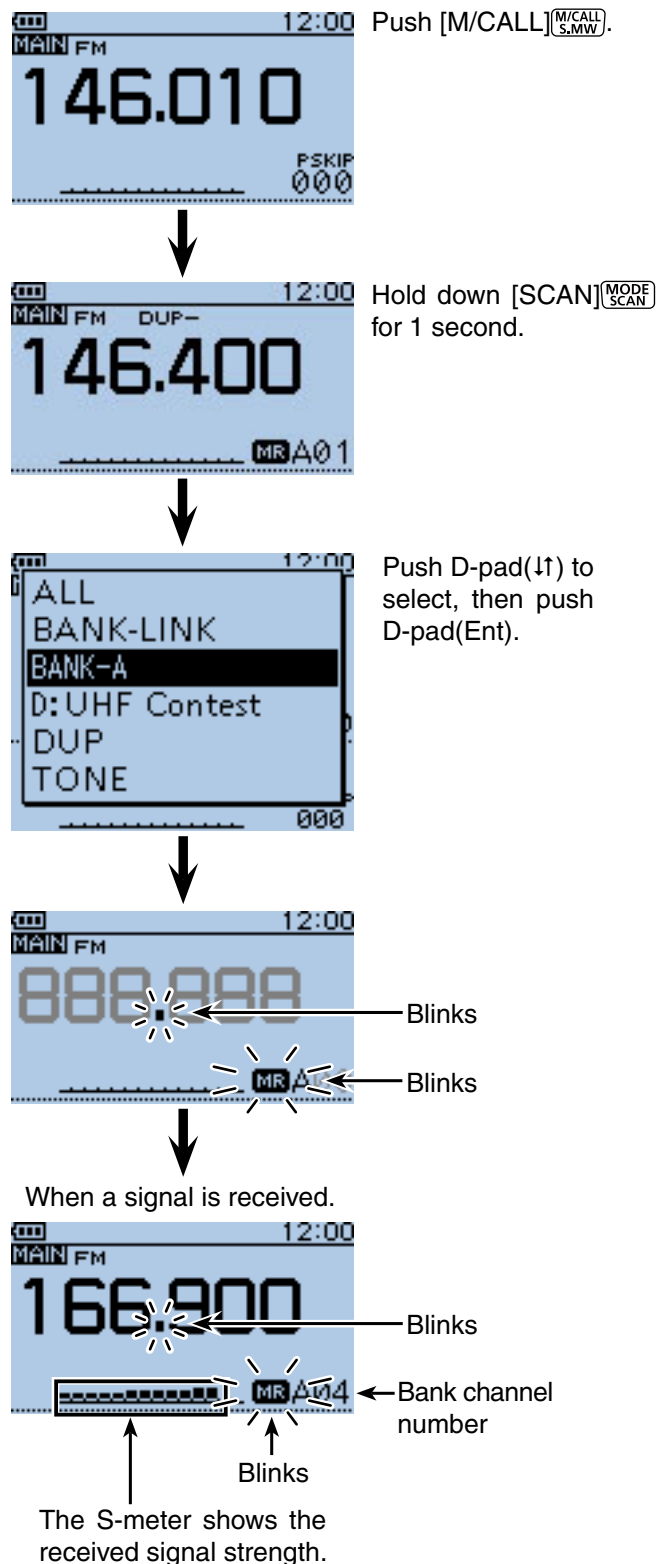

## 13 SCAN OPERATION

- Memory scan
- ◇ Memory bank scan (continued)

### When a bank name is programmed

When a bank name is programmed, the scan type can be set by selecting the bank name from the scan type list. (Step ⑥ on page 13-10.)

/// **NOTE:** The bank name is not displayed during a scan.

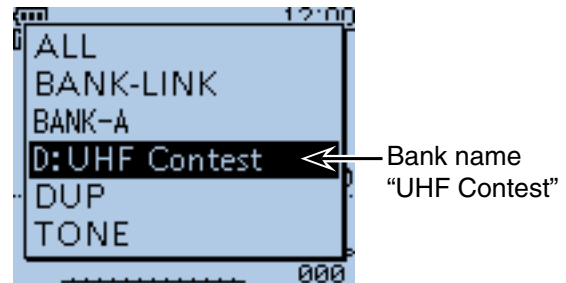

- When the bank name is programmed.



## ■ Setting the skip channel

The channels set as “SKIP” or “PSKIP” skip channels are skipped (not scanned).

See page 13-8 for details of clearing the skip setting.

- ① Push [M/CALL]  one or more times to select the Memory mode.
- ② Rotate [DIAL] to select the memory channel to be set as a skip channel.
- ③ Push [QUICK] .
- ④ Push D-pad(↑) to select “SKIP” or “PSKIP,” and then push D-pad(Ent).

  - OFF : Cancel the skip setting.
  - SKIP : Skipped during a memory scan.
  - PSKIP : Skipped during both VFO and memory scans.

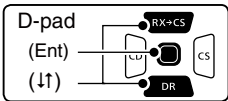

- ⑤ Push D-pad(Ent) to save the selection.
  - The skip setting is set.

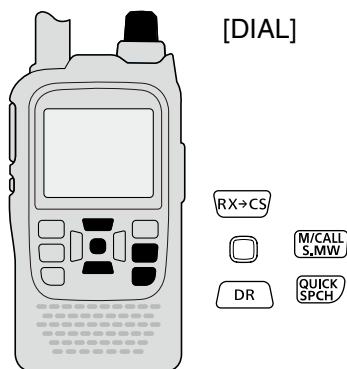

### Example: Set “SKIP” to Memory channel “009.”

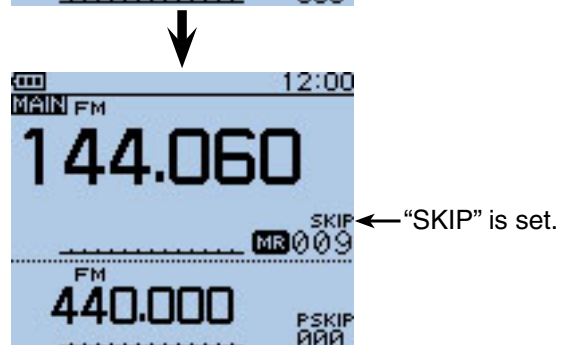
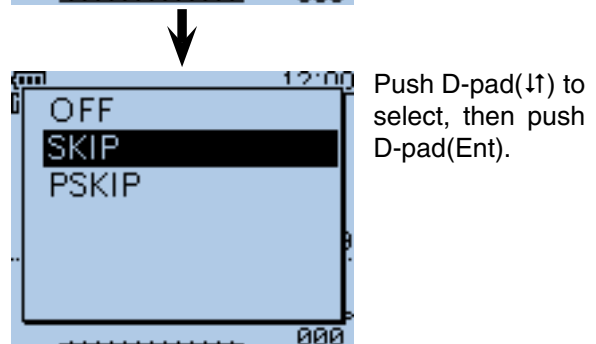
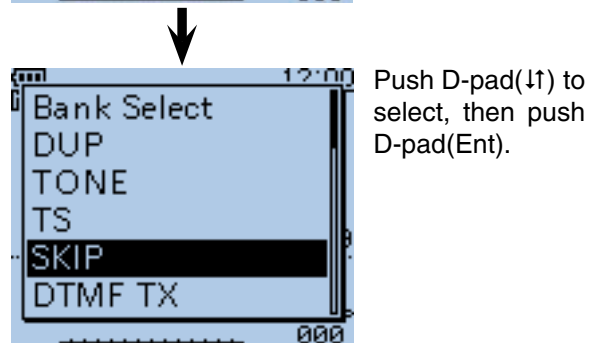
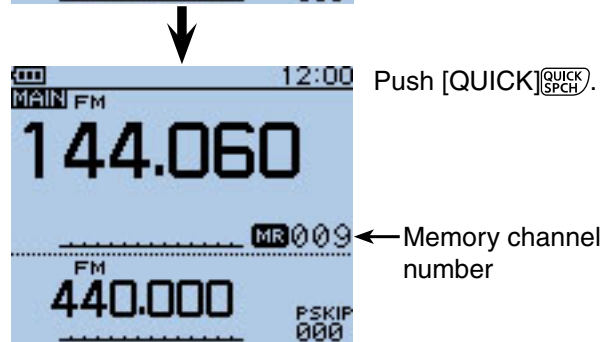
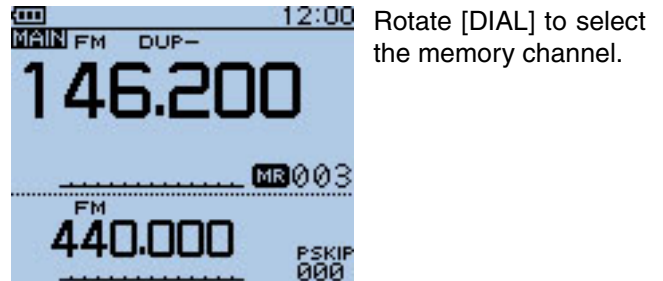

## ■ Setting the temporary skip function

This function temporarily skips unwanted frequencies during a scan, for the set period.

This function enables you to temporarily skip the unwanted frequencies without the skip frequency setting.

- ① Start the scan. (pp. 13-5, 13-9)
  - When a signal is received, the scan pauses.
- ② While the scan is paused, and if you want to skip the frequency, push [QUICK]<sup>[QUICK SPCH]</sup>.
- ③ Push D-pad(↑) to select “Temporary Skip,” and then push D-pad(Ent).

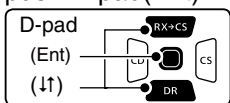

- ④ After pushing D-pad(Ent), the scan resumes.
  - The frequency will be skipped for the Temporary Skip time period.
  - After the Temporary Skip time period passes, or the scan is cancelled, the Temporary Skip is also cancelled.

▨ The Temporary Skip time period is set to “5 minutes” by default.  
 ▨ You can change the setting in the MENU screen.  
 ▨ (MENU > Scan > **Temporary Skip Timer**)

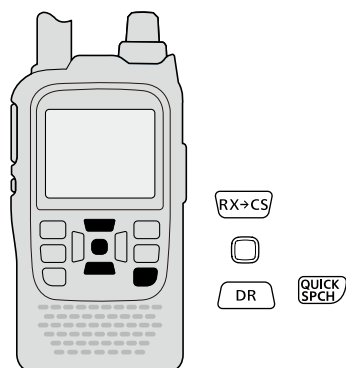

### ✓ Convenient!

During Memory or DR mode scanning, follow steps ② and ④ to skip the channel for the set period (Default: 5 minutes).

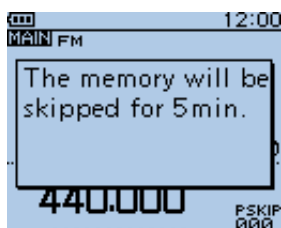

### Example: Full scan in the FM mode.

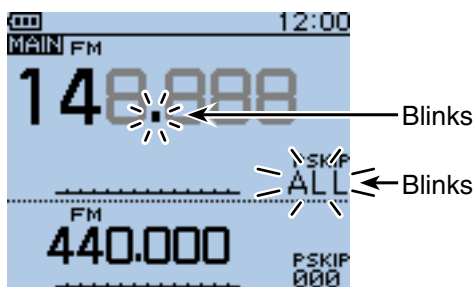

When a signal is received.

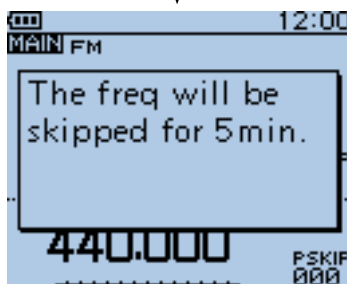
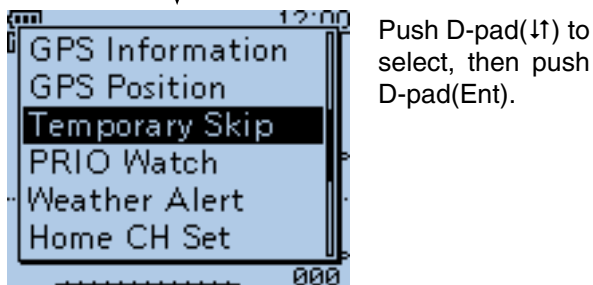
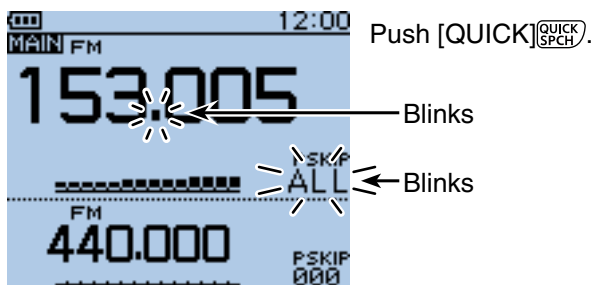

Up to 5 Temporary Skip frequencies or memories can be set.

When the 6th frequency or memory is set, the pop up screen appears as shown to the right, and the oldest frequency or memory is automatically deleted.

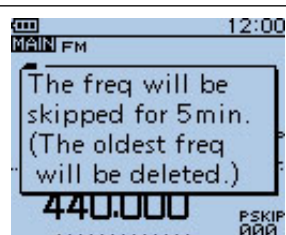



## Section 14 PRIORITY WATCH

---

■ Priority watch.....	14-2
◇ VFO frequency and a priority channel.....	14-2
◇ VFO frequency and a Memory/Bank scan ....	14-2
◇ VFO scan and a priority channel.....	14-2
◇ VFO scan and a Memory/Bank scan.....	14-2
◇ DR mode and a priority channel.....	14-3
◇ DR mode scan and a priority channel.....	14-3
■ VFO frequency and a priority channel.....	14-4
■ VFO frequency and a Memory/Bank scan .....	14-6
■ VFO scan and a priority channel.....	14-8
■ VFO scan and Memory/Bank scan.....	14-10
■ DR mode and a priority channel.....	14-13
■ DR mode scan and a priority channel .....	14-16

## Priority watch

While operating on a VFO frequency, DR mode or while scanning, Priority watch checks for signals on a selected frequency every 5 seconds.

### ◇ VFO frequency and a priority channel

(p. 14-4)

Checks the selected priority channel every 5 seconds, while receiving on a VFO frequency.

Memory channel, Bank channel or Call channel can be selected as the priority channel

#### • VFO frequency and a Memory channel

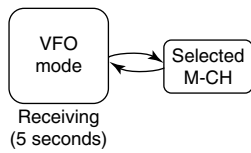

#### • VFO frequency and a Bank channel

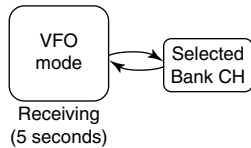

#### • VFO frequency and a Call channel

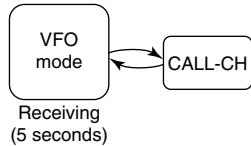

### ◇ VFO frequency and a Memory/Bank scan

(p. 14-6)

Sequentially checks the Memory or Bank channels every 5 seconds, while receiving on a VFO frequency.

Memory scan or Bank scan can be selected.

#### • VFO frequency and a Memory scan

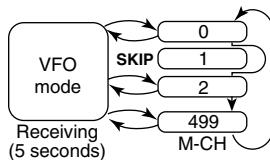

#### • VFO frequency and a Bank scan

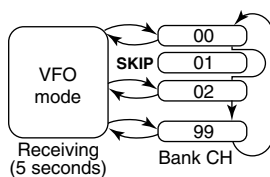

### ◇ VFO scan and a priority channel

(p. 14-8)

Checks the selected priority channel every 5 seconds, during a VFO mode scan.

Memory channel, Bank channel or Call channel can be selected as the priority channel

#### • VFO scan and a Memory channel

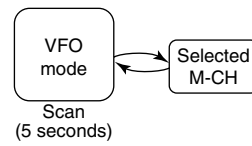

#### • VFO scan and a Bank channel

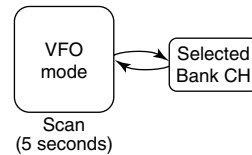

#### • VFO scan and a Call channel

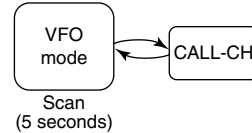

### ◇ VFO scan and a Memory/Bank scan

(p. 14-10)

Sequentially checks the Memory or Bank channels every 5 seconds, during a VFO mode scan.

Memory scan or Bank scan can be selected.

#### • VFO scan and a Memory scan

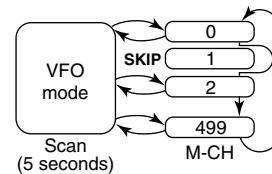

#### • VFO scan and a Bank scan

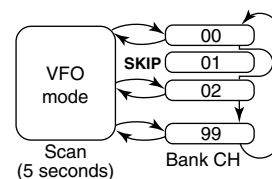

■ PRIORITY WATCH (Continued)

◇ DR mode and a priority channel

(p. 14-13)

Checks a priority channel every 5 seconds, while receiving on a **repeater** in the DR mode.

VFO frequency, Memory channel, Bank channel or Call channel can be selected as the priority channel

• DR mode and a VFO frequency

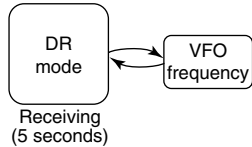

• DR mode and a Memory channel

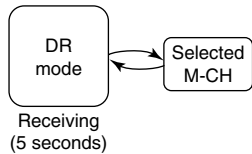

• DR mode and a Bank channel

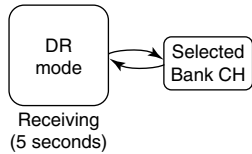

• DR mode and a Call channel

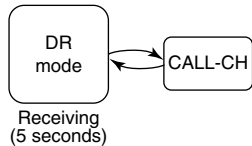

◇ DR mode scan and a priority channel

(p. 14-16)

Checks a priority channel every 5 seconds, during a DR mode scan.

VFO frequency, Memory channel, Bank channel or Call channel can be selected as the priority channel

• DR mode scan and a VFO frequency

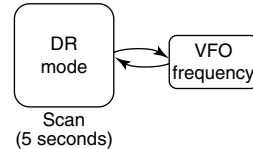

• DR mode scan and a Memory channel

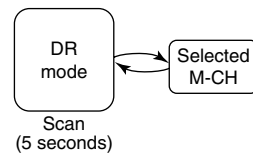

• DR mode scan and a Bank channel

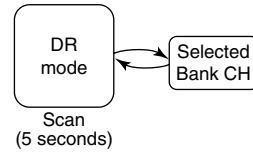

• DR mode scan and a Call channel

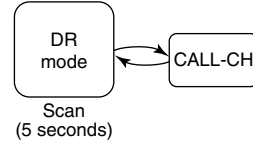

## ■ VFO frequency and a priority channel

Checks the selected priority channel every 5 seconds, while receiving on a VFO frequency.

### 1. Set the VFO frequency

- 1 Push [V/MHz]<sup>(V/MHz CLR LOW)</sup> to select the VFO mode.
- 2 Rotate [DIAL] to set the receive frequency.

### 2. Set the priority channel

#### • In case of the Memory channel

- 1 Push [M/CALL]<sup>(M/CALL S.MW)</sup> to select the Memory mode.
- 2 Rotate [DIAL] to select the Memory channel you want to watch.

#### • In case of the Bank channel

- 1 Push [M/CALL]<sup>(M/CALL S.MW)</sup> to select the Memory mode.
- 2 Rotate [DIAL] to select the Bank channel you want to watch.

#### **How to select the Memory and Bank:**

- 1 In the Memory mode, push [QUICK]<sup>(QUICK SPCH)</sup>.
- 2 Push D-pad(↑) to select "Bank Select," and then push D-pad(Ent).
  - The Bank list is displayed.
- 3 Push D-pad(↑) to select a desired bank and then push D-pad(Ent).
  - If "OFF" is selected, cancel the bank selection.

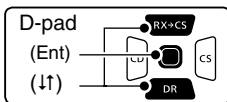

#### • In case of the Call channel

- 1 Push [M/CALL]<sup>(M/CALL S.MW)</sup> one or more times to select the Call channel mode.
- 2 Rotate [DIAL] to select the Call channel you want to watch.

### 3. Start the Priority scan

- 1 Push [QUICK]<sup>(QUICK SPCH)</sup>.
- 2 Push D-pad(↑) to select "PRIO Watch," and then push D-pad(Ent).
- 3 Push D-pad(↑) to select "ON" or "Bell."
  - ON : When a signal is received on the priority channel, the channel is automatically selected.
  - Bell : When a signal is received on the priority channel, the "(•)" icon is displayed in the VFO mode.
- 4 Push D-pad(Ent) to start the Priority scan.
  - The "PRIO" icon appears

#### **NOTE:**

- You can set the priority channel (Step 2) before setting the VFO frequency (Step 1).
- Push [CLR]<sup>(V/MHz CLR LOW)</sup> to cancel the Priority scan.

Example: Checks Memory channel "490" every 5 seconds, while receiving on 145.800 MHz.

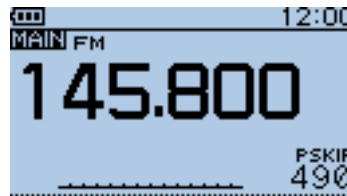

Rotate [DIAL] to set the receive frequency.

Push [M/CALL]<sup>(M/CALL S.MW)</sup>.

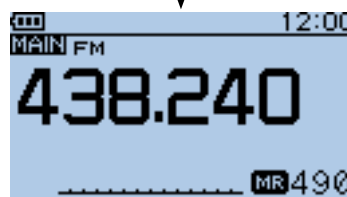

Rotate [DIAL] to select the Memory channel.

Push [QUICK]<sup>(QUICK SPCH)</sup>.

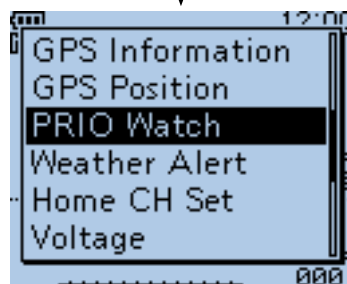

Push D-pad(↑) to select, then push D-pad(Ent).

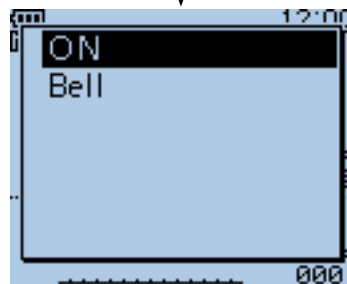

Push D-pad(↑) to select, then push D-pad(Ent).



[DIAL]

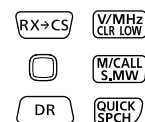

Continued on the next page.

■ VFO frequency and a priority channel (Continued)

4. During the Priority scan

Checks the selected priority channel every 5 seconds, while receiving on a VFO frequency.

Example: Checks M-CH “490” while receiving on 145.800 MHz frequency.

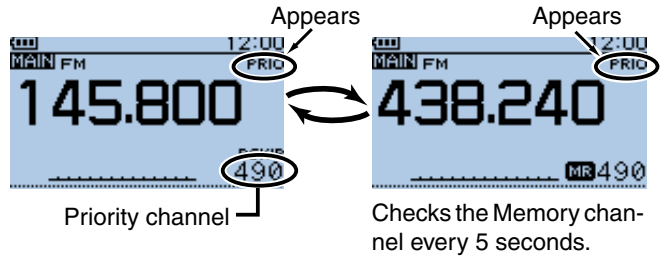

Example: Checks Bank CH “D06” while receiving on 145.800 MHz frequency.

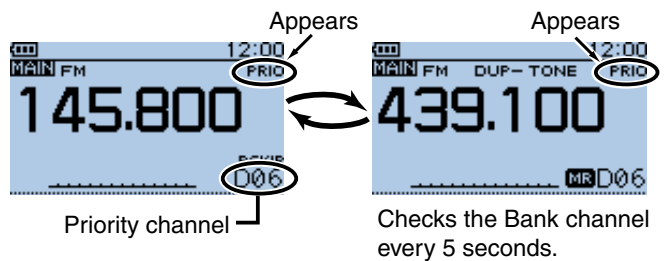

Example: Checks Call CH “C3” while receiving on 145.800 MHz frequency.

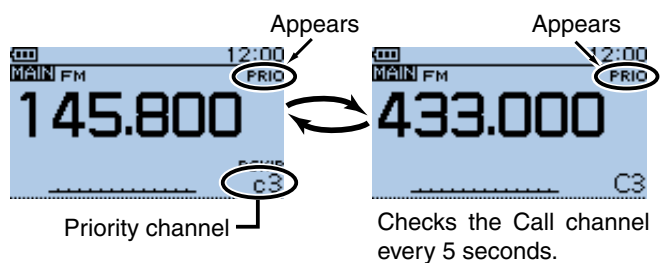

5. When a signal is received

• When “ON” is selected.

When a signal is received on the priority channel, the channel is automatically selected. The “PRIO” icon blinks on the screen.  
 - The scan pause timer and resume settings are the same as for a normal scan. (p. 16-18)

• When “Bell” is selected.

When a signal is received on the priority channel, a beep sounds and the “(••)” icon blinks on the screen.

Example: In case of the Memory channel

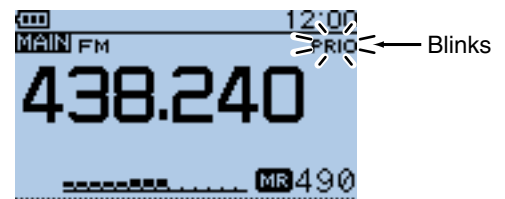

Automatically selects the priority channel.

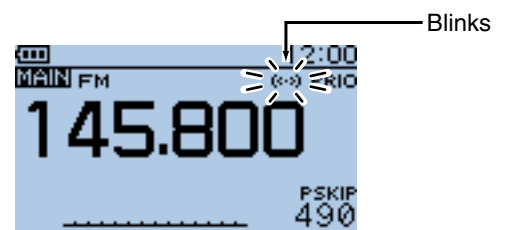

Remains the VFO mode.

## ■ VFO frequency and a Memory/Bank scan

Sequentially checks the Memory or Bank channels every 5 seconds, while receiving on a VFO frequency.

### 1. Set the VFO frequency

- ① Push [V/MHZ]<sup>[V/MHZ CLR LOW]</sup> to select the VFO mode.
- ② Rotate [DIAL] to set the receive frequency.

### 2. Start the Memory or Bank scan

#### • In case of the Memory scan

- ① Push [M/CALL]<sup>[M/CALL S.MW]</sup> to select the Memory mode.
- ② Hold down [SCAN]<sup>[MODE SCAN]</sup> for 1 second.
- ③ Push D-pad(↑) to select the scan type, and then push D-pad(Ent) to start the Memory scan. (p. 13-9)

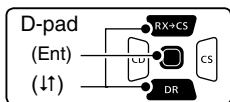

#### • In case of the Bank scan

- ① Push [M/CALL]<sup>[M/CALL S.MW]</sup> to select the Memory mode.
- ② Hold down [SCAN]<sup>[MODE SCAN]</sup> for 1 second.
- ③ Push D-pad(↑) to select the scan type, and then push D-pad(Ent) to start the Bank scan. (p. 13-10)

#### How to select the Memory and Bank:

- ① In the Memory mode, push [QUICK]<sup>[QUICK SPCH]</sup>.
- ② Push D-pad(↑) to select "Bank Select," and then push D-pad(Ent).
  - The Bank list is displayed.
- ③ Push D-pad(↑) to select a desired bank and then push D-pad(Ent).
  - If "OFF" is selected, cancel the bank selection.

### 3. Start the Priority scan

- ① Push [QUICK]<sup>[QUICK SPCH]</sup>.
- ② Push D-pad(↑) to select "PRIO Watch," and then push D-pad(Ent).
- ③ Push D-pad(↑) to select "ON" or "Bell."
  - ON : When a signal is received on the priority channel, the channel is automatically selected.
  - Bell : When a signal is received on the priority channel, the "(•)" icon is displayed in the VFO mode.
- ④ Push D-pad(Ent) to start the Priority scan.
  - The "PRIO" icon appears

NOTE: Push [CLR]<sup>[V/MHZ CLR LOW]</sup> to cancel the Priority and Memory/Bank scan at the same time.

Example: Sequentially checks the Memory channels every 5 seconds, while receiving on 145.800 MHz.

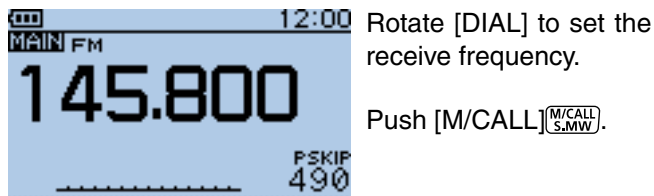

Rotate [DIAL] to set the receive frequency.

Push [M/CALL]<sup>[M/CALL S.MW]</sup>.

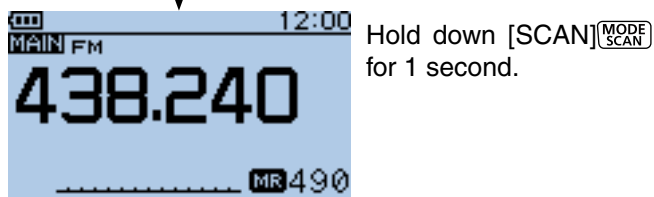

Hold down [SCAN]<sup>[MODE SCAN]</sup> for 1 second.



Push D-pad(↑) to select, then push D-pad(Ent).

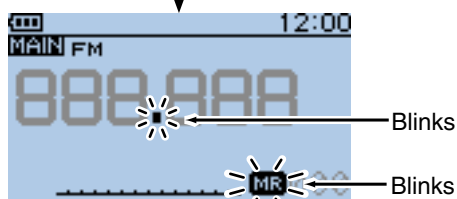

Blinks

Blinks

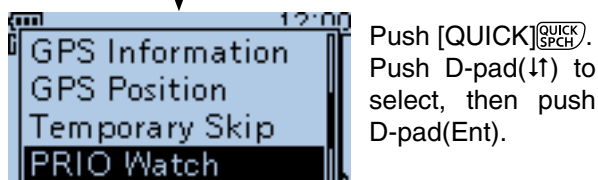

Push [QUICK]<sup>[QUICK SPCH]</sup>. Push D-pad(↑) to select, then push D-pad(Ent).



Push D-pad(↑) to select, then push D-pad(Ent).

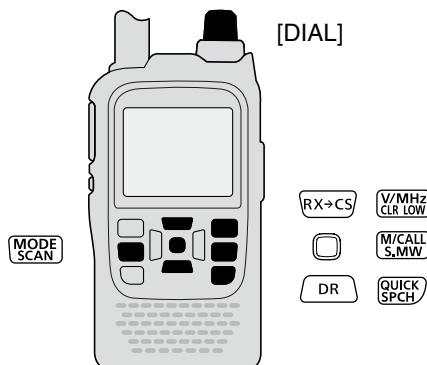

Continued on the next page.

■ VFO frequency and a Memory/Bank scan (Continued)

**4. During the Priority scan**

Sequentially checks the Memory or Bank channels every 5 seconds, while receiving on a VFO frequency.

Example: Sequentially checks the Memory channels while receiving on 145.800 MHz frequency.

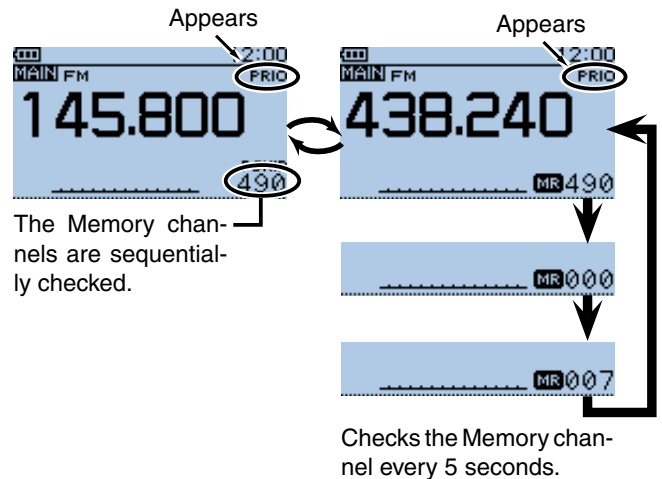

Example: Sequentially checks Bank channels while receiving on 145.800 MHz frequency.

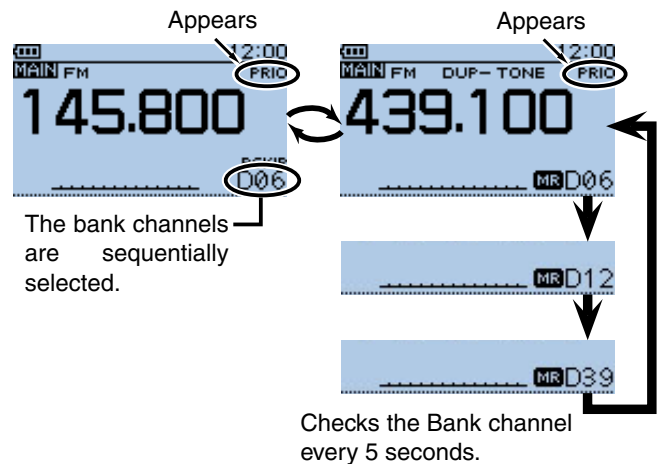

**5. When a signal is received**

• **When “ON” is selected.**

When a signal is received on the priority channel, the channel is automatically selected. The “PRIO” icon blinks on the screen.  
 - The scan pause timer and resume settings are the same as for a normal scan. (p. 16-18)

• **When “Bell” is selected.**

When a signal is received on the priority channel, a beep sounds and the “(••)” icon blinks on the screen.

Example: In case of the Memory scan

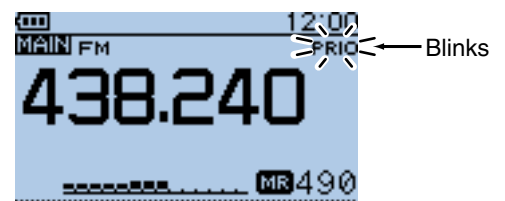

Automatically selects the Memory channel.

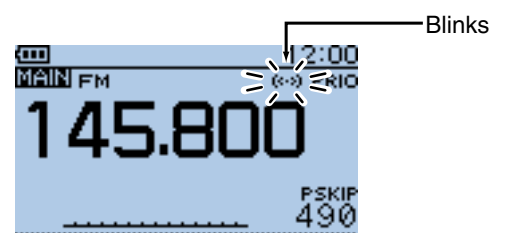

## VFO scan and a priority channel

Checks the selected priority channel every 5 seconds, during a VFO mode scan.

### 1. Set the priority channel

**In case of the Memory channel**

- 1 Push [M/CALL]<sup>[M/CALL S, MW]</sup> to select the Memory mode.
- 2 Rotate [DIAL] to select the Memory channel you want to watch.

**In case of the Bank channel**

- 1 Push [M/CALL]<sup>[M/CALL S, MW]</sup> to select the Memory mode.
- 2 Rotate [DIAL] to select the Bank channel you want to watch.

**How to select the Memory and Bank:**

- 1 In the Memory mode, push [QUICK]<sup>[QUICK SPCH]</sup>.
- 2 Push D-pad(↑) to select "Bank Select," and then push D-pad(Ent).
  - The Bank list is displayed.
- 3 Push D-pad(↑) to select a desired bank and then push D-pad(Ent).
  - If "OFF" is selected, cancel the bank selection.

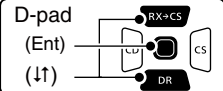

**In case of the Call channel**

- 1 Push [M/CALL]<sup>[M/CALL S, MW]</sup> one or more times to select the Call channel mode.
- 2 Rotate [DIAL] to select the Call channel you want to watch.

### 2. Start the Priority scan

- 1 Push [QUICK]<sup>[QUICK SPCH]</sup>.
- 2 Push D-pad(↑) to select "PRIO Watch," and then push D-pad(Ent).
- 3 Push D-pad(↑) to select "ON" or "Bell."
  - ON : When a signal is received on the priority channel, the channel is automatically selected.
  - Bell : When a signal is received on the priority channel, the "(•)" icon is displayed in the VFO mode.
- 4 Push D-pad(Ent) to start the Priority scan.
  - The "PRIO" icon appears.

### 3. Start the VFO scan

- 1 Hold down [SCAN]<sup>[MODE SCAN]</sup> for 1 second.
- 2 Push D-pad(↑) to select the scan type, and then push D-pad(Ent) to start the VFO scan (p. 13-5).

NOTE: Push [CLR]<sup>[V/MHZ CLR LOW]</sup> to cancel both scans.

Example: Checks memory channel "490" every 5 seconds, during a VFO scan.

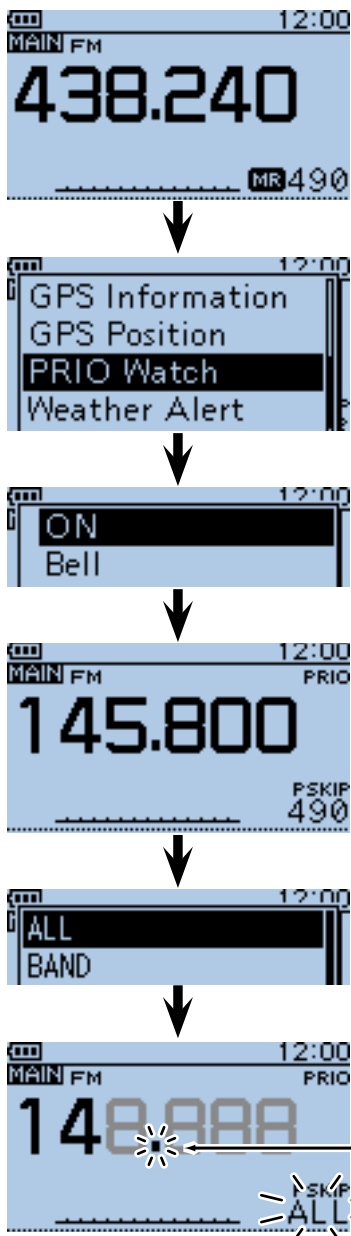

Push [M/CALL]<sup>[M/CALL S, MW]</sup>, then rotate [DIAL] to select the Memory channel.

Push [QUICK]<sup>[QUICK SPCH]</sup>.

Push D-pad(↑) to select, then push D-pad(Ent).

Push D-pad(↑) to select, then push D-pad(Ent).

Hold down [SCAN]<sup>[MODE SCAN]</sup> for 1 second.

Push D-pad(↑) to select, then push D-pad(Ent).

Blinks

Blinks

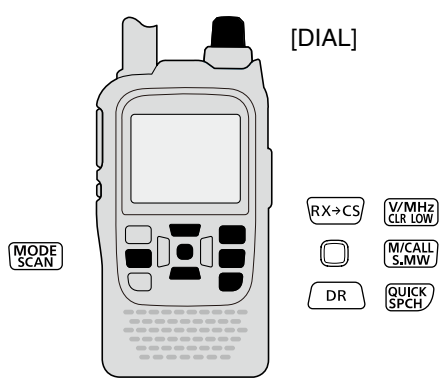

Continued on the next page.



■ VFO scan and a priority channel (Continued)

**4. During the Priority scan**

Checks the selected priority channel every 5 seconds, while VFO scanning

Example: Checks M-CH “490” while VFO scanning

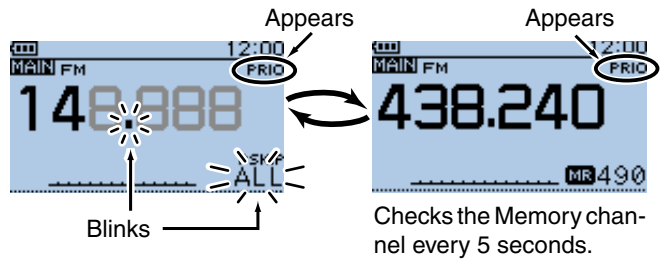

Example: Checks Bank-CH “D06” while VFO scanning

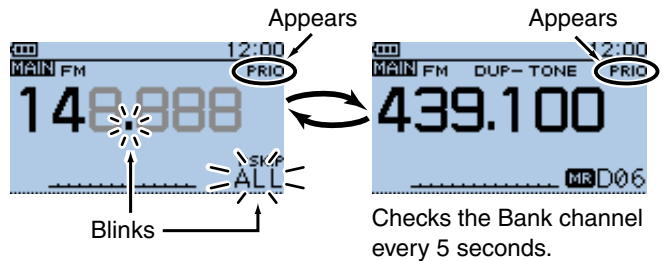

Example: Checks Call-CH “C3” while VFO scanning

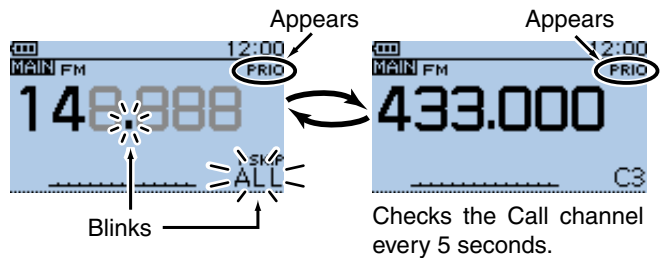

**5. When a signal is received.**

• **When “ON” is selected.**

When a signal is received on the priority channel, the channel is automatically selected.

The “PRIO” icon blinks.

\* The scan pause timer and resume settings are the same as for a normal scan.

• **When “Bell” is selected.**

When a signal is received on the priority channel, a beep sounds and the “(•)” icon blinks. The VFO scan resumes.

Example: In case of the Memory channel

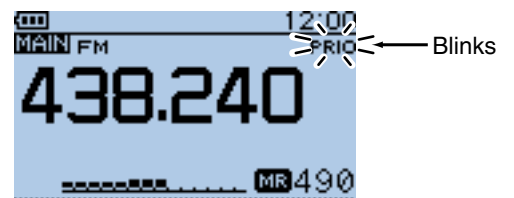

Automatically selects the priority channel.

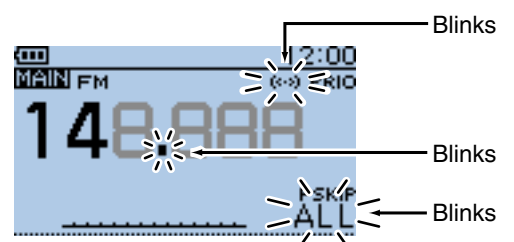

Remains the VFO mode.

## VFO scan and Memory/Bank scan

Sequentially checks the Memory or Bank channels every 5 seconds during a VFO scan.

### 1. Start the Memory or Bank scan

**In case of the Memory scan**

- 1 Push [M/CALL]<sup>[M/CALL S.MW]</sup> to select the Memory mode.
- 2 Hold down [SCAN]<sup>[MODE SCAN]</sup> for 1 second.
- 3 Push D-pad(↑) to select the scan type, and then push D-pad(Ent) to start the Memory scan. (p. 13-9)

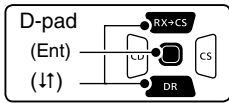

**In case of the Bank scan**

- 1 Push [M/CALL]<sup>[M/CALL S.MW]</sup> to select the Memory mode.
- 2 Hold down [SCAN]<sup>[MODE SCAN]</sup> for 1 second.
- 3 Push D-pad(↑) to select the scan type, and then push D-pad(Ent) to start the Bank scan. (p.13-10)

**How to select the Memory and Bank:**

- 1 In the Memory mode, push [QUICK]<sup>[QUICK SPCH]</sup>.
- 2 Push D-pad(↑) to select “Bank Select,” and then push D-pad(Ent).
  - The Bank list is displayed.
- 3 Push D-pad(↑) to select a desired bank and then push D-pad(Ent).
  - If “OFF” is selected, cancel the bank selection.

### 2. Start the Priority scan

- 1 Push [QUICK]<sup>[QUICK SPCH]</sup>.
- 2 Push D-pad(↑) to select “PRIO Watch,” and then push D-pad(Ent).
- 3 Push D-pad(↑) to select “ON” or “Bell.”
  - ON :When a signal is received on the priority channel, the channel is automatically selected.
  - Bell :When a signal is received on the priority channel, the “(•)” icon is displayed in the VFO mode.
- 4 Push D-pad(Ent) to start the Priority scan.
  - The “PRIO” icon appears

Example: Sequentially checks the memory channels every 5 seconds during a VFO scan.

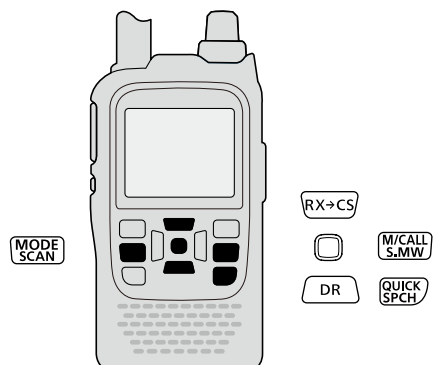
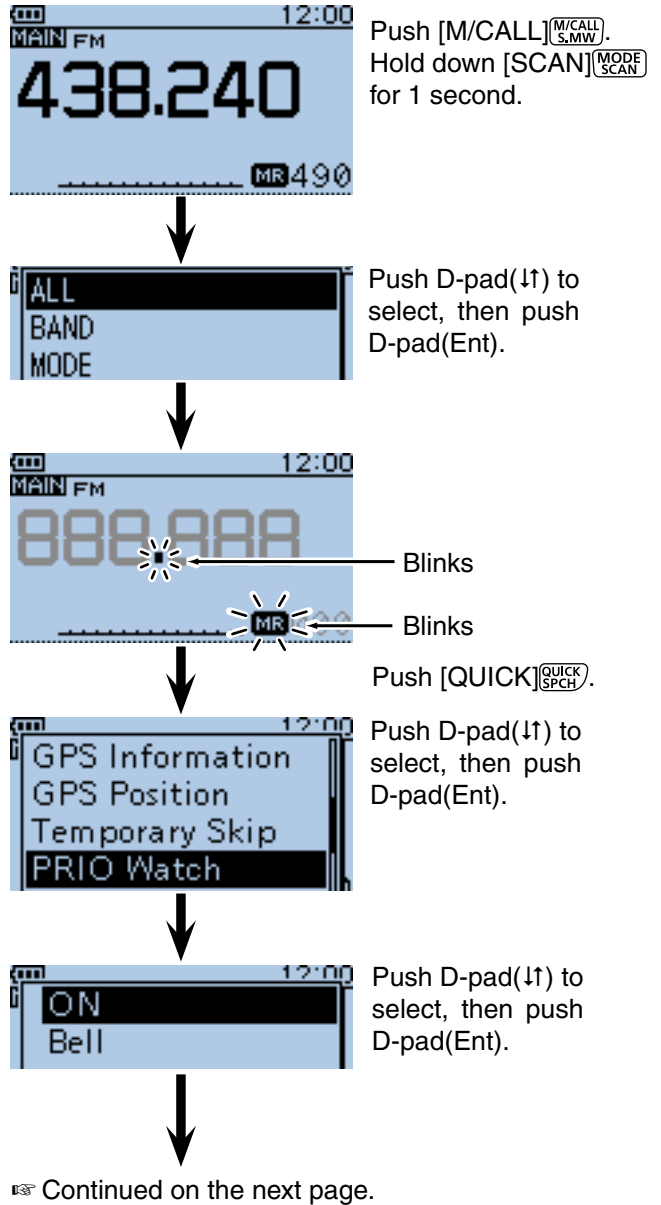

■ VFO scan and Memory/Bank scan (Continued)

3. Start the VFO scan

- ① Hold down [SCAN] <sup>(MODE)</sup> <sub>(SCAN)</sub> for 1 second.
- ② Push D-pad(↑) to select the scan type, and then push D-pad(Ent) to start the VFO scan (p. 13-5).

**NOTE:** Push [CLR] <sup>(V/MHz)</sup> <sub>(CLR LOW)</sub> to cancel the all scans at the same time.

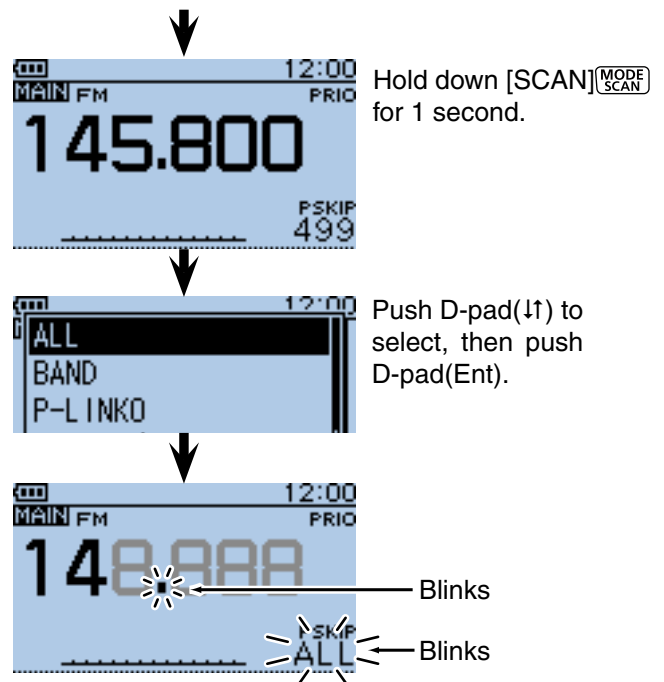

4. During the Priority scan

Checks the selected priority channel every 5 seconds, while VFO scanning.

Example: Checks the Memory channels while VFO scanning

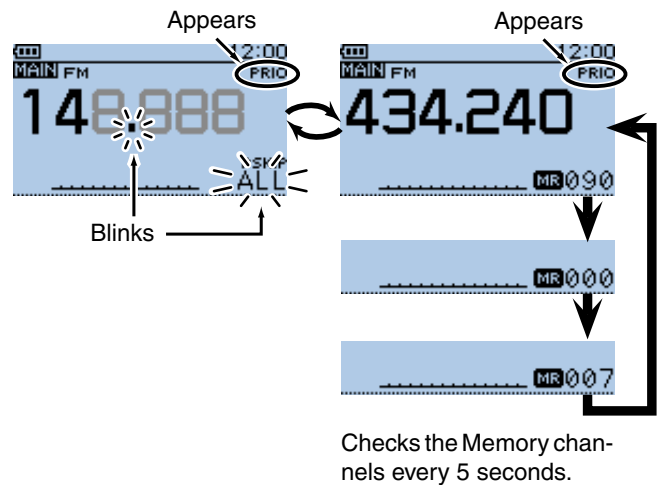

Example: Checks the Bank channels while VFO scanning

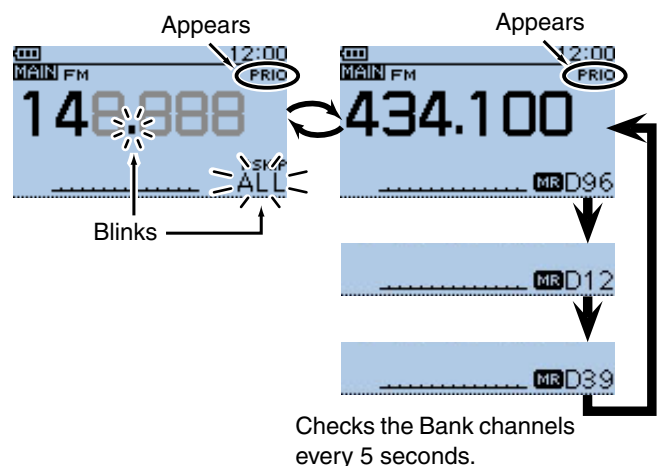

■ VFO scan and Memory/Bank scan (Continued)

5. When a signal is received.

• When “ON” is selected.

When a signal is received on the priority channel, the channel is automatically selected.

The “PRIO” icon blinks.

\* The scan pause timer and resume settings are the same as for a normal scan.

• When “BELL” is selected.

When a signal is received on the priority channel, a beep sounds and the “((•))” icon blinks.

The VFO scan resumes.

Example: In case of the Memory scan

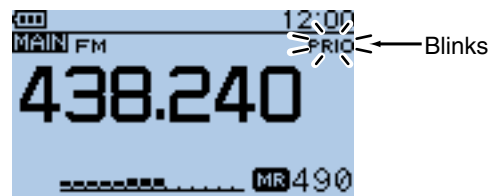

Automatically selects the Memory channel.

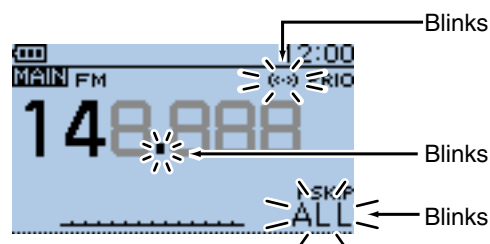

Remains the VFO mode.

## ■ DR mode and a priority channel

Checks the selected priority channel every 5 seconds, while receiving a **repeater** in the DR mode.

### 1. Set the priority channel

**• In case of the VFO frequency**

- 1 Push [V/MHz]<sup>[V/MHz CLR LOW]</sup> to select the VFO mode.
- 2 Rotate [DIAL] to set the receive frequency.

**• In case of the Memory channel**

- 1 Push [M/CALL]<sup>[M/CALL S.MW]</sup> to select the Memory mode.
- 2 Rotate [DIAL] to select the Memory channel you want to watch.

**• In case of the Bank channel**

- 1 Push [M/CALL]<sup>[M/CALL S.MW]</sup> to select the Memory mode.
- 2 Rotate [DIAL] to select the Bank channel you want to watch.

**How to select the Memory and Bank:**

- 1 In the Memory mode, push [QUICK]<sup>[QUICK SPCH]</sup>.
- 2 Push D-pad(↑) to select “Bank Select,” and then push D-pad(Ent).
  - The Bank list is displayed.
- 3 Push D-pad(↑) to select a desired bank and then push D-pad(Ent).
  - If “OFF” is selected, cancel the bank selection.

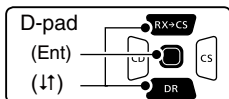

**• In case of the Call channel**

- 1 Push [M/CALL]<sup>[M/CALL S.MW]</sup> one or more times to select the Call channel mode.
- 2 Rotate [DIAL] to select the Call channel you want to watch.

### 2. Select the repeater in the DR mode

- 1 Hold down [DR] for 1 second to select the DR mode.
- 2 Push D-pad(↓) to select the “FROM” (Access repeater) item.
- 3 Rotate [DIAL] to select the desired repeater.

### 3. Start the Priority scan

- 1 Push [QUICK]<sup>[QUICK SPCH]</sup>.
- 2 Push D-pad(↑) to select “PRIO Watch,” and then push D-pad(Ent).
- 3 Push D-pad(↑) to select “ON” or “Bell.”
  - ON : When a signal is received on the priority channel, the channel is automatically selected.
  - Bell : When a signal is received on the priority channel, the “(•)” icon is displayed in the VFO mode.
- 4 Push D-pad(Ent) to start the Priority scan.
  - The “PRIO” icon appears

Example: Checks “145.800 MHz” every 5 seconds, while receiving on the repeater in the DR mode.

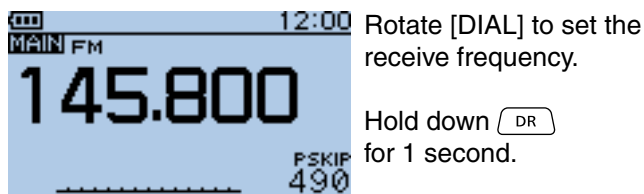

Hold down [DR] for 1 second.

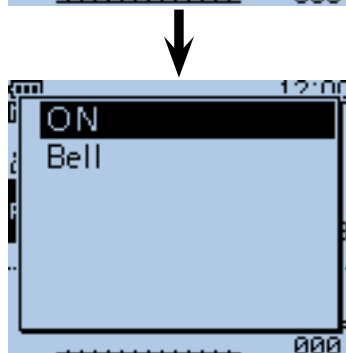
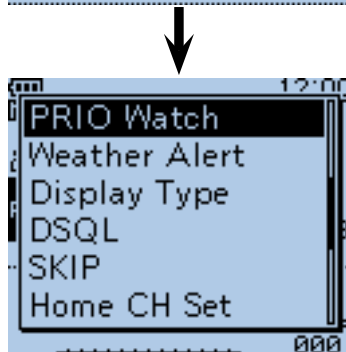
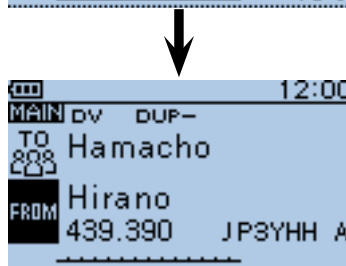

NOTE: Push [CLR]<sup>[V/MHz CLR LOW]</sup> to cancel the Priority scan.

Continued on the next page.

■ DR mode and a priority channel (Continued)

4. During the Priority scan

Checks the selected priority channel every 5 seconds, while receiving a **repeater** in the DR mode.

Example: Checks the VFO frequency while receiving a repeater in the DR mode.

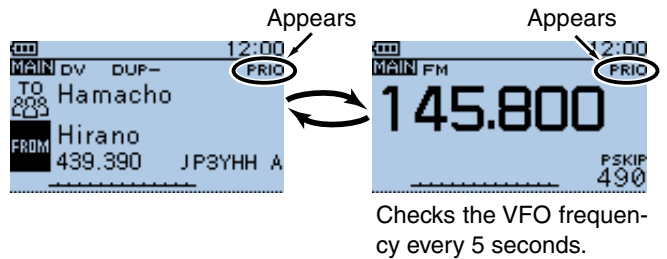

Example: Checks the M-CH “490” while receiving a repeater in the DR mode.

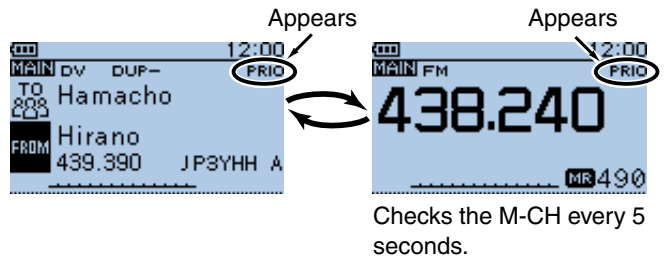

Example: Checks the Bank CH “D06” while receiving a repeater in the DR mode.

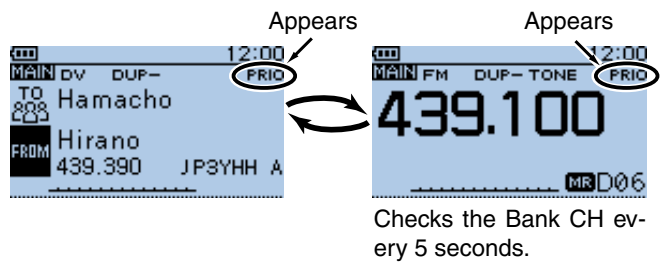

Example: Checks the Call CH “C3” while receiving a repeater in the DR mode.

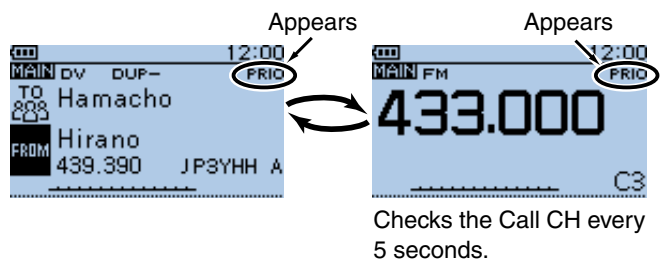

■ DR mode and a priority channel (Continued)

5. When a signal is received.

• When “ON” is selected.

When a signal is received on the priority channel, the channel is automatically selected.

The “PRIO” icon blinks.

\* The scan pause timer and resume settings are the same as for a normal scan.

• When “Bell” is selected.

When a signal is received on the priority channel, a beep sounds and the “PRIO” icon blinks on the screen.

Example: In case of the Memory channel

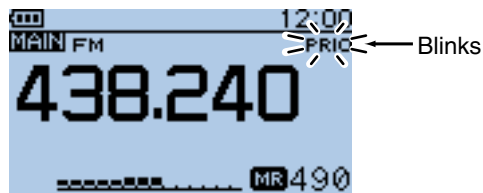

Automatically selects the priority channel.

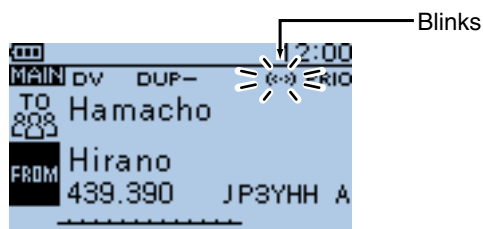

Remains the DR mode.

## ■ DR mode scan and a priority channel

Checks the selected priority channel every 5 seconds, during a DR mode scan.

### 1. Set the priority channel

**• In case of the VFO frequency**

- ① Push [V/MHz] to select the VFO mode.
- ② Rotate [DIAL] to set the receive frequency.

**• In case of the Memory channel**

- ① Push [M/CALL] to select the Memory mode.
- ② Rotate [DIAL] to select the Memory channel you want to watch.

**• In case of the Bank channel**

- ① Push [M/CALL] to select the Memory mode.
- ② Rotate [DIAL] to select the Bank channel you want to watch.

**How to select the Memory and Bank:**

- ① In the Memory mode, push [QUICK] .
- ② Push D-pad(↓) to select “Bank Select,” and then push D-pad(Ent).
  - The Bank list is displayed.
- ③ Push D-pad(↑) to select a desired bank and then push D-pad(Ent).
  - If “OFF” is selected, cancel the bank selection.

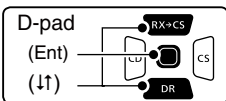

**• In case of the Call channel**

- ① Push [M/CALL] one or more times to select the Call channel mode.
- ② Rotate [DIAL] to select the Call channel you want to watch.

### 2. Start the DR mode scan

- ① Hold down for 1 second to select the DR mode.
- ② Hold down [SCAN] for 1 second.
  - The DR mode scan starts.

### 3. Start the Priority scan

- ① Push [QUICK] .
- ② Push D-pad(↓) to select “PRIO Watch,” and then push D-pad(Ent).
- ③ Push D-pad(↑) to select “ON” or “Bell.”
  - ON : When a signal is received on the priority channel, the channel is automatically selected.
  - Bell : When a signal is received on the priority channel, the “(•)” icon is displayed in the VFO mode.
- ④ Push D-pad(Ent) to start the Priority scan.
  - The “PRIO” icon appears

Example: Checks “145.800 MHz” every 5 seconds, during the DR mode scan

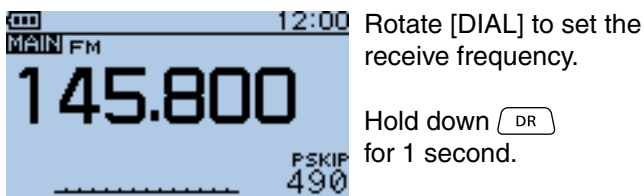

Rotate [DIAL] to set the receive frequency.

Hold down for 1 second.

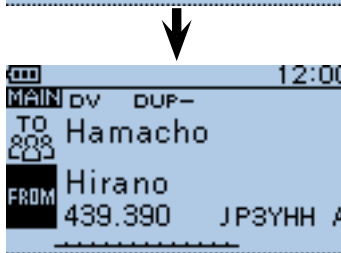

Hold down [SCAN] for 1 second.

The DR mode scan starts.

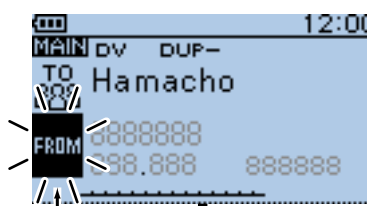

Push [QUICK] .

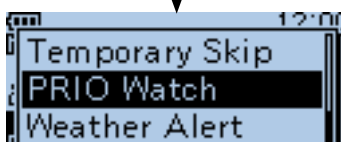

Push D-pad(↑) to select, then push D-pad(Ent).



Push D-pad(↑) to select, then push D-pad(Ent).

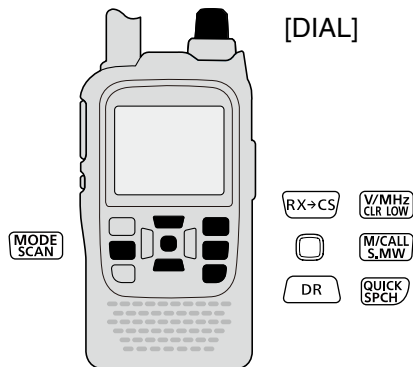

**NOTE:**

- You can start the priority scan (Step 3) before starting the DR mode scan (Step 2).
- Push [CLR] to cancel the Priority scan and the DR mode scan.

Continued on the next page.



■ DR mode scan and a priority channel (Continued)

4. During the Priority scan

Checks the selected priority channel every 5 seconds, during a DR mode scan.

Example: Checks the VFO frequency during the DR mode scan.

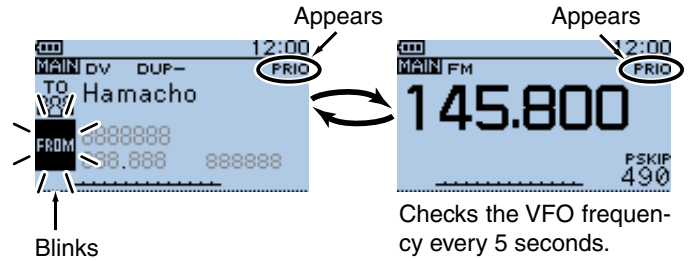

Example: Checks the M-CH "490" during the DR mode scan.

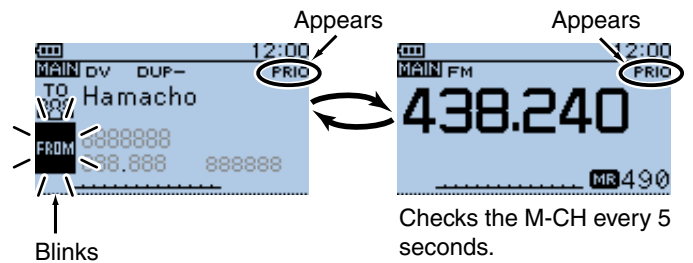

Example: Checks the Bank CH "D06" during the DR mode scan.

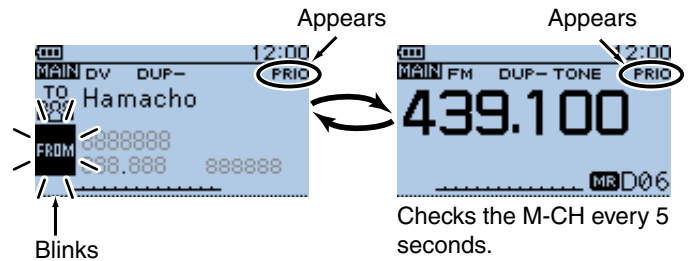

Example: Checks the Call CH "C3" during the DR mode scan.

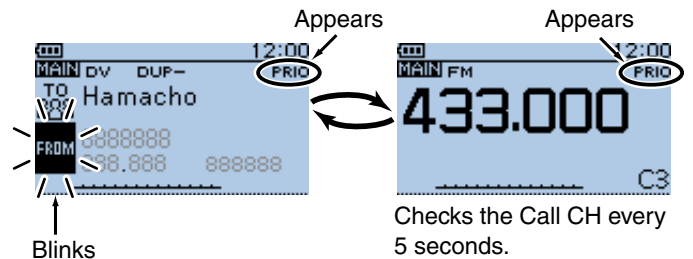

■ DR mode scan and a priority channel (Continued)

5. When a signal is received.

• When “ON” is selected.

When a signal is received on the priority channel, the channel is automatically selected. The “PRIO” icon blinks.

Push [CLR]  $\left[ \begin{smallmatrix} \text{V/MHz} \\ \text{CLR LOW} \end{smallmatrix} \right]$  to resume the priority scan. Push it again to cancel the scan.

\* The scan pause timer and resume settings are the same as for a normal scan.

• When “Bell” is selected.

When a signal is received on the priority channel, a beep sounds and the “PRIO” icon blinks. The DR mode scan resumes.

Example: In case of the Memory channel

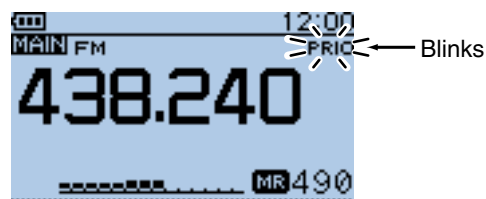

Automatically selects the priority channel.

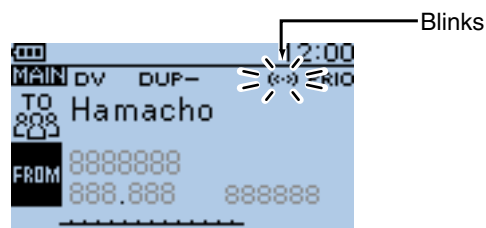

Remains the DR mode.

# Section 15 REPEATER AND DUPLEX OPERATIONS

---

- FM Repeater operation..... 15-2
  - ◇ Checking the repeater input signal..... 15-3
- Duplex operation ..... 15-4
  - ◇ Setting the frequency offset..... 15-4
  - ◇ Setting the duplex direction ..... 15-5
  - ◇ Duplex operation ..... 15-5
- Off band indication ..... 15-5
- Auto repeater function ..... 15-6
  - ◇ Auto repeater setting ..... 15-6
  - ◇ Frequency range and offset direction ..... 15-6
- 1750 Hz tone ..... 15-7

## ■ FM Repeater operation

A **repeater** receives transmitted signals and retransmits them on a different frequency. The transmit frequency is shifted from the receive frequency by a preset **frequency offset**.

In **duplex** operation, the transceiver's frequency offset is set to the same as that of the repeater. (p. 16-16)

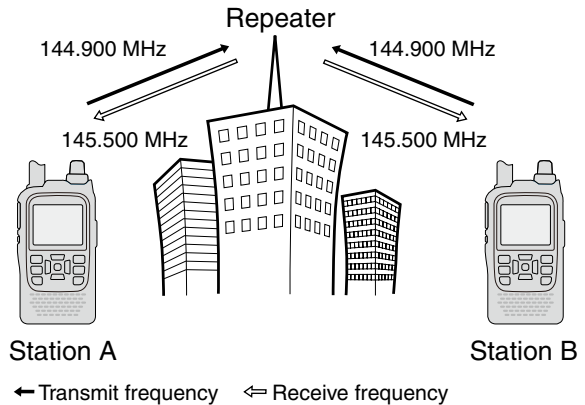

- ① Push [V/MHz] to select the VFO mode.
- ② Push [MODE] several times to select the FM mode.
- ③ Rotate [DIAL] to set the receive frequency (repeater output frequency).
  - The frequency changes according to the preset tuning steps. See the page 5-6 for details.

**Only USA and Korean versions have an Auto Repeater function:**

When the function is turned ON, steps ④ and ⑤ are not necessary.\*

- (Default for USA version : ON (DUP))
- (Default for Korean version : ON)

The Auto Repeater function can be turned OFF in the Auto Repeater item of the MENU screen.

(MENU > Function > **Auto Repeater**)

See page 16-66 for details.

- ④ Set the duplex offset direction. (p. 15-5)
  - “DUP-” or “DUP+” appears.
  - The frequency offset can be set in the “Offset Freq” screen. (p. 15-4)
  - (MENU > DUP/TONE... > **Offset Freq**)
- ⑤ Push [QUICK] , and push D-pad(↑) to select “TONE,” and then push D-pad(Ent).

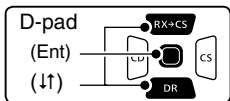

- ⑥ Push D-pad(↓) to select “TONE,” and then push D-pad(Ent).
  - “TONE” appears.
  - The tone frequency can be set in the “Repeater Tone” screen. 88.5 Hz is set by default. (p. 16-16)
  - (MENU > DUP/TONE... > **Repeater Tone**)
- ⑦ Communicate in the normal way.

\*For the USA version, the Auto repeater function turns ON the duplex operation only. To turn ON the repeater tone, you should manually set as step ⑤, or select “ON (DUP, TONE)” in the Auto Repeater item of the MENU screen. (p. 16-66)

**NOTE:**

- The Auto repeater function uses the preset repeater tone frequency and frequency offset. Depending on the frequency offset value, the off band indication, “OFF,” appears on the display when [PTT] is pushed, and transmit is inhibited. (p. 15-5)
- See Section 8 for details on accessing a D-STAR repeater.

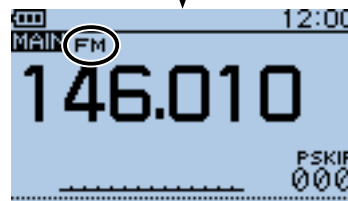
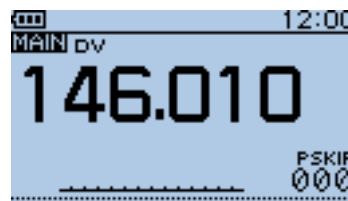

Push [MODE] to select the FM mode.

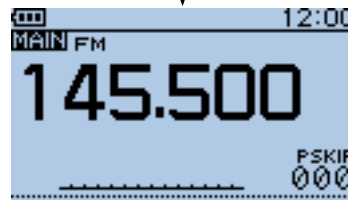

Rotate [DIAL] to set the receive frequency.

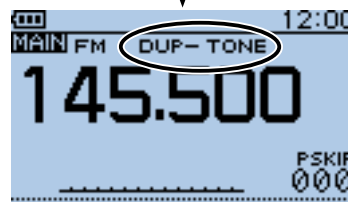

Set the duplex offset direction and turn ON the repeater tone.

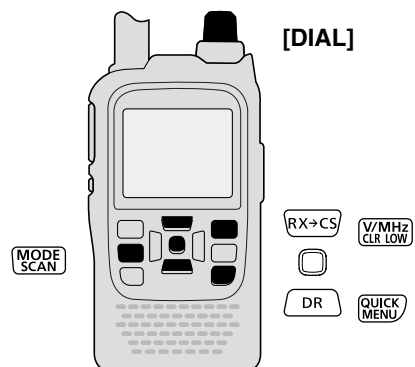

## ■ FM Repeater operation (Continued)

### ◇ Checking the repeater input signal

You can check whether the other station's transmit signal can be received directly or not, by listening on the **repeater** input frequency.

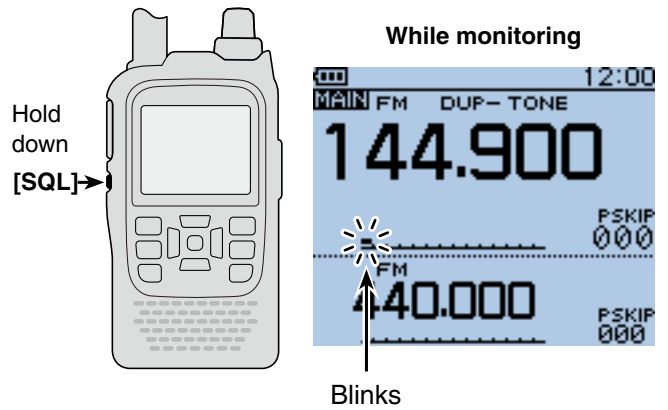

- ➔ Hold down [SQL] to listen on the repeater input frequency.
  - While monitoring, the TX/RX indicator lights green, and an S/RF meter dot blinks.
  - While monitoring, the displayed frequency automatically changes to the transmit frequency (repeater input frequency).
  - When the other station's signal can be directly received, move to a non-repeater frequency and use **simplex**. (duplex OFF)





## Duplex operation

The **Duplex** operation shifts the transmit frequency up or down from the receive frequency by an offset amount.

### Setting the frequency offset

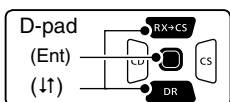
- ① Push [V/MHz]  to select the VFO mode.
- ② Push [MENU] .
- ③ Push D-pad(1) to select the root item (“DUP/TONE...”), and then push D-pad(Ent).



- ④ Push D-pad(1) to select the “Offset Freq,” and then push D-pad(Ent).
- ⑤ Rotate [DIAL] to set the **frequency offset** to between 0.000.00 and 59.99500 MHz, and then push D-pad(Ent). (Setting example: 1.000.00 MHz)
  - The selected tuning step in the VFO mode is used when setting the frequency offset.
  - Pushing [V/MHz]  toggles the tuning digit, as shown below.

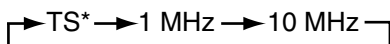

\*The frequency changes according to the preset tuning steps. (p. 5-6)

- ⑥ Push [MENU]  to exit the [MENU] screen.

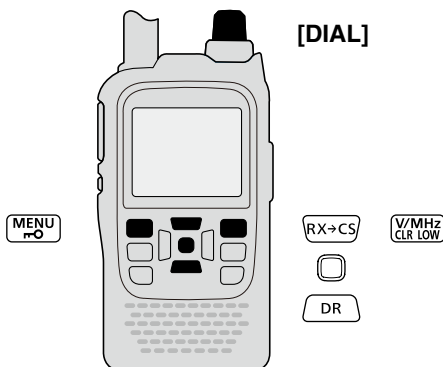

### To reset to the default value.

Push [QUICK]  in step ⑤ as described above, then push D-pad(Ent) to reset to the default value.

### NOTE:

- The frequency offset cannot be changed in the DR mode.
- The Auto **repeater** function uses the preset frequency offset. Depending on the frequency offset value, the off band indication, “OFF,” appears on the display when [PTT] is pushed. (p. 15-5)

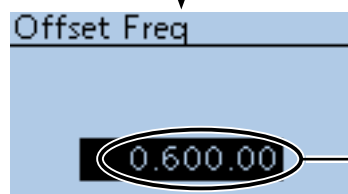
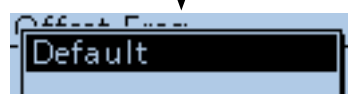
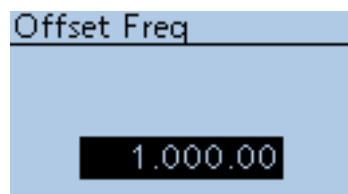
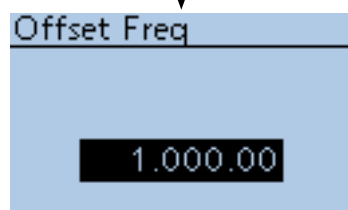
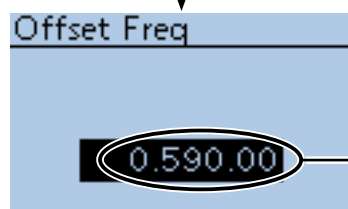
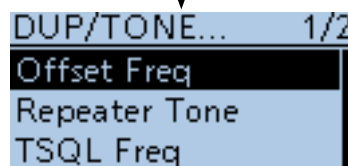
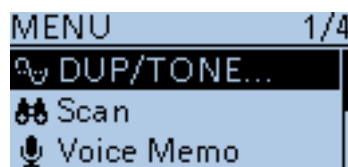

■ Duplex operation (Continued)

◇ **Setting the duplex direction**

- ① Push [V/MHz]<sub>CLR LOW</sub> to select the VFO mode.
- ② Rotate [DIAL] to set the operating frequency.
- ③ Push [QUICK]<sub>QUICK SPCH</sub>.
- ④ Push D-pad(↑) to select "DUP," and then push D-pad(Ent).

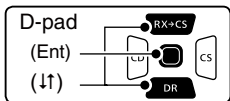

- ⑤ Push D-pad(↓) to select "DUP-" (negative offset) or "DUP+" (positive offset), and then push D-pad(Ent) to save, and exit the Quick Menu screen.
  - OFF : For **simplex** operation (the receive and transmit frequencies are the same).
  - DUP- : The transmit frequency shifts down from the receive frequency by the offset amount.
  - DUP+ : The transmit frequency shifts up from the receive frequency by the offset amount.

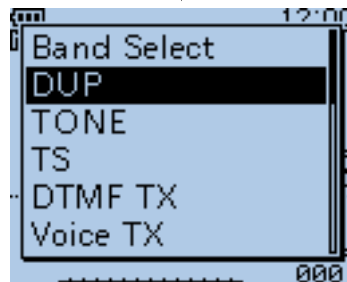
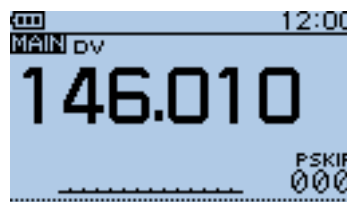
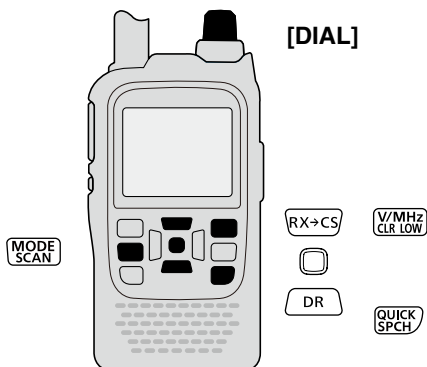

Push D-pad(↓) to select, then push D-pad(Ent).

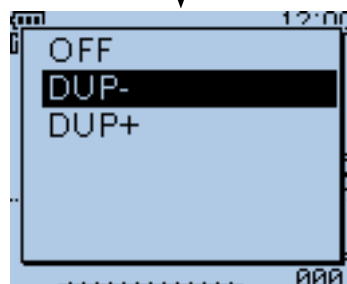

Push D-pad(↓) to select, then push D-pad(Ent).

◇ **Duplex operation**

- ① Push [MODE]<sub>MODE SCAN</sub> several times to select the FM mode.
- ② Hold down [SQL] to listen on the **repeater** input frequency.
  - The transmit frequency (repeater input frequency) appears on the function display.
- ③ Communicate in the normal way.

/// **NOTE:**

When the Auto repeater is ON, and the operating frequency is set out of the repeater output frequency range, the duplex is automatically cancelled.

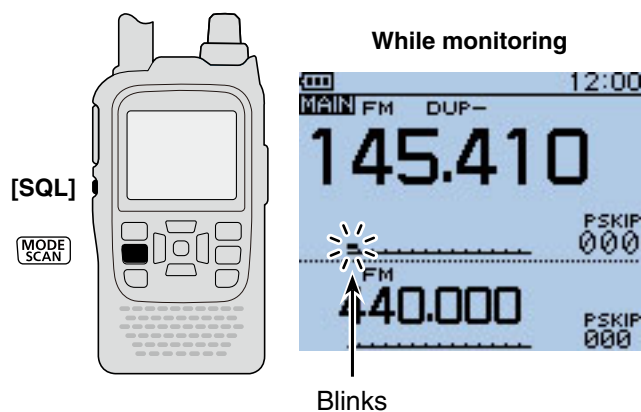

■ **Off band indication**

If the transmit frequency is out of the amateur band, the off band indication, "OFF," appears on the display when [PTT] is pushed. Check the **frequency offset** (p. 15-4) or duplex direction (see above) in this case.

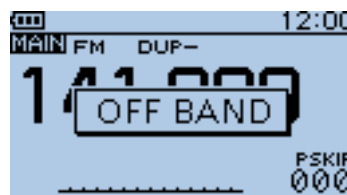

## ■ Auto repeater function

When the operating frequency falls within the **repeater** output frequency range, the Auto Repeater function can automatically sets the repeater settings (duplex ON/OFF, **duplex** direction, tone encoder ON/OFF). The Auto repeater function uses the preset repeater tone frequency and **frequency offset**. See page 16-16 for details of the setting.

### ◇ Auto repeater setting

- ① Push [MENU]  to enter the MENU screen.
- ② Push D-pad(↑) to select the root item (“Function”), and then push D-pad(Ent).

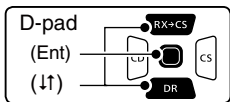

- ③ Push D-pad(↑) to select “Auto Repeater,” and then push D-pad(Ent).
- ④ Rotate [DIAL] to select the Auto repeater setting.

**U.S.A. version:**

- OFF : The Auto repeater function is OFF.
- ON (DUP) : Turns ON only the duplex operation. (Default)
- ON (DUP, TONE) : Turns ON the duplex operation and tone encoder

**Korean version:**

- OFF : The Auto repeater function is OFF.
- ON : Turns ON the duplex operation and tone encoder. (Default)

- ⑤ Push [MENU]  to save, and exit the MENU screen.

**NOTE:** When turned ON, the Auto repeater function uses the preset repeater tone frequency and frequency offset. See page 16-16 for details of the setting.

**For the U.S.A. and Korean versions:**

When turned ON, the Auto repeater function has priority over the manual duplex setting. If the transmit frequency changes after setting, the Auto repeater function may have changed the duplex setting.

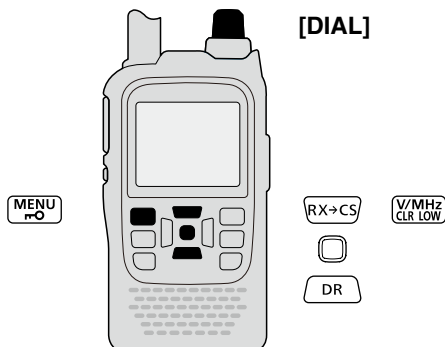

### ◇ Frequency range and offset direction

• U.S.A. version

FREQUENCY RANGE	SHIFT DIRECTION
145.200–145.495 MHz	“DUP–” is set
146.610–146.995 MHz	“DUP–” is set
147.000–147.395 MHz	“DUP+” is set
442.000–444.995 MHz	“DUP+” is set
447.000–449.995 MHz	“DUP–” is set

• Korean version

FREQUENCY RANGE	SHIFT DIRECTION
439.000–440.000 MHz	“DUP–” is set

A series of three screenshots showing the menu navigation process. 
 1. The first screenshot shows the 'MENU' screen with 'Function' selected. An arrow points to the right with the text 'Push [MENU] '.
 2. The second screenshot shows the 'FUNCTION' screen with 'Auto Repeater' selected. An arrow points to the right with the text 'Push D-pad(↑) to select, then push D-pad(Ent)'.
 3. The third screenshot shows the 'Auto Repeater' screen with 'ON (DUP)' selected. An arrow points to the right with the text 'Push D-pad(↑) to select, then push D-pad(Ent)'.



## ■ 1750 Hz tone

To access most European repeaters, the transceiver must transmit a 1750 Hz tone. For such European repeaters, do the following procedures.

• This tone can also be used as a 'Call signal.'

### ▨ For only the ID-51E:

Push [PTT] briefly, then hold down [PTT] to transmit a 1750 Hz tone burst signal.

① Push D-pad(↓) to select the root item ("DTMF/T-CALL"), and then push D-pad(Ent).

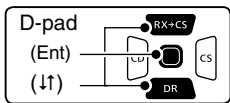

② Push D-pad(↑) to select "DTMF Memory," and then push D-pad(Ent).

③ Rotate [DIAL] to select "T-CALL," and then push D-pad(Ent) to set.

④ Push [MENU] to exit the MENU screen.

⑤ Rotate [DIAL] to set the receive frequency (repeater output frequency).

⑥ Set the duplex offset direction. (p. 15-5)

• "DUP-" or "DUP+" appears.

⑦ While holding down [PTT], push [SQL] to transmit a 1750 Hz tone signal.

• If "OFF BAND" appears, check the frequency offset or shift direction. (pp. 15-4, 15-5)

• While transmitting, the displayed frequency automatically changes to the transmit frequency (repeater input frequency).

⑧ Hold down [SQL] to check whether the other station's transmit signal can be received directly or not, by listening on the repeater input frequency.

• While monitoring, the TX/RX indicator lights green, and the S/R meter dot blinks.

• While monitoring, the displayed frequency automatically changes to the transmit frequency (repeater input frequency).

• If you can hear the other station, you may want to change to the Simplex mode and contact directly.

⑨ Push [PTT] to transmit.

⑩ Release [PTT] to receive.

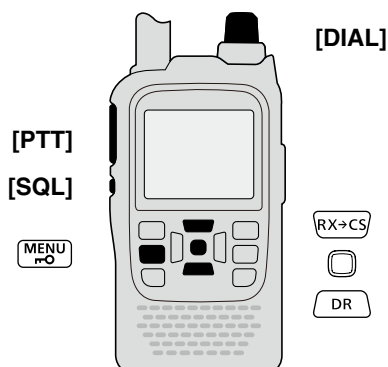

Push [MENU].

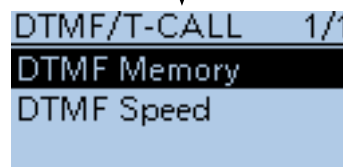

Push D-pad(↑) to select, then push D-pad(Ent).

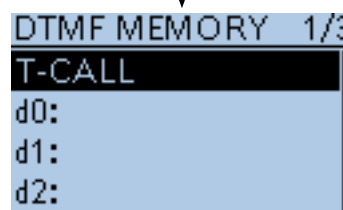

Push D-pad(↑) to select, then push D-pad(Ent).

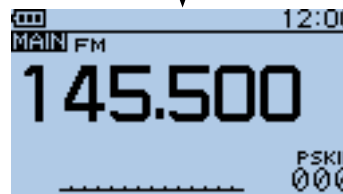

Rotate [DIAL] to set the receive frequency.

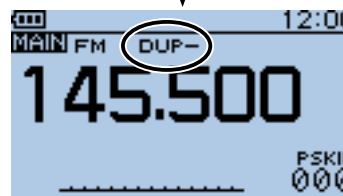

Set the duplex offset direction.

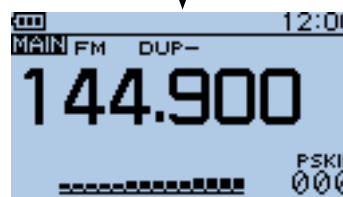

While holding down [PTT], push [SQL] to transmit a 1750 Hz tone signal.

# Section 16 MENU SCREEN

---

■ Menu item selection.....	16-2
◇ Entering the Menu screen .....	16-3
■ Menu items and Default settings .....	16-4
■ DUP/TONE items .....	16-16
■ Scan items.....	16-18
■ Voice Memo items .....	16-22
■ Voice TX items.....	16-28
■ Broadcast (BC) Radio items.....	16-30
■ GPS items .....	16-32
■ Call sign items .....	16-48
■ RX History items.....	16-50
■ DV Memory items .....	16-52
■ My Station items.....	16-54
■ DV Set items.....	16-55
■ SPEECH items .....	16-59
■ DTMF/T-CALL items.....	16-61
■ QSO/RX Log items .....	16-62
■ Function items .....	16-65
■ Display items .....	16-72
■ Sounds items.....	16-78
■ Time set items .....	16-82
■ SD Card items .....	16-84
■ Others items .....	16-85

## Menu item selection

The MENU system is used to program infrequently changed values or function settings.

In addition to this page, see pages 16-4 through 16-15 for details of each item's options and their default value.

**NOTE:** The Menu system is constructed in a tree structure. You may go to the next tree level, or go back a level, depending on the selected item.

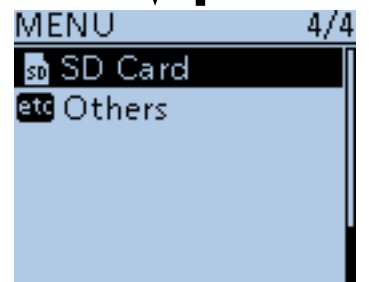
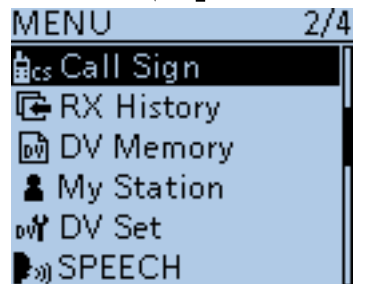
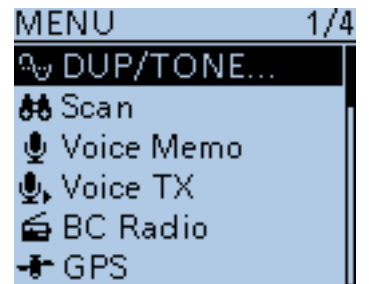
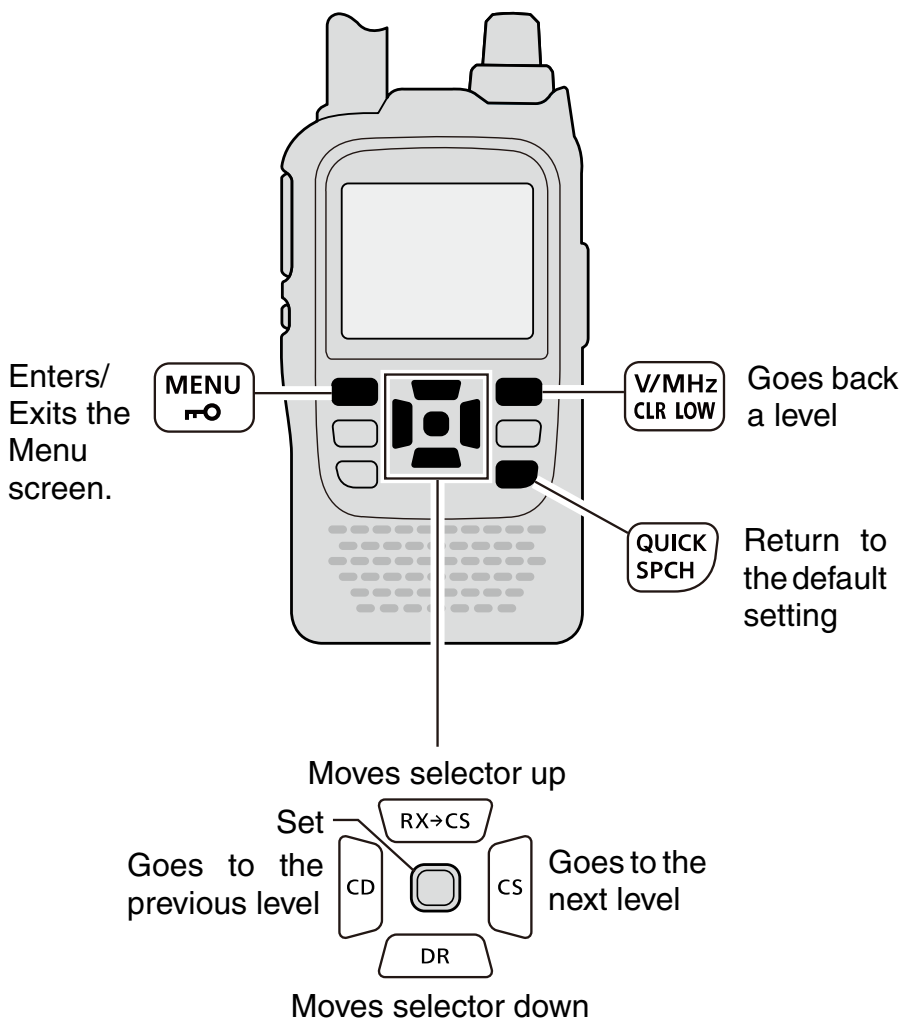



■ Menu item selection (Continued)

◇ Entering the Menu screen

Example: Set the Auto Power OFF function to “30 min.”

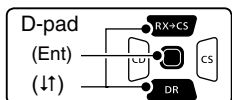
- ① Push [MENU] .
- ② Push D-pad(↑) to select the root item (“Time Set”), and then push D-pad(Ent).
  - If D-pad(↑) is continuously held down, the items are quickly scrolled.



- ③ Push D-pad(↑) to select “Auto Power OFF,” and then push D-pad(Ent).
- ④ Push D-pad(↑) to select “30min.”
- ⑤ Push [MENU]  to save, and exit the Menu screen.

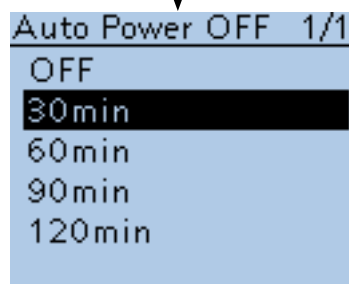
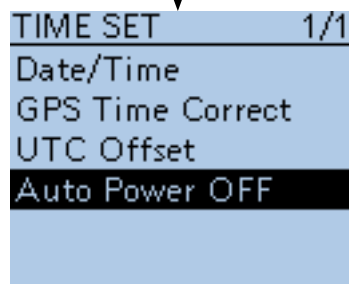
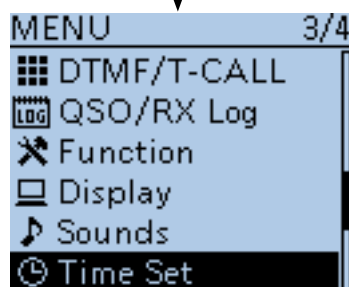

To return to the default setting, push [QUICK]  in step ④ to display “Default,” and then push D-pad(Ent).

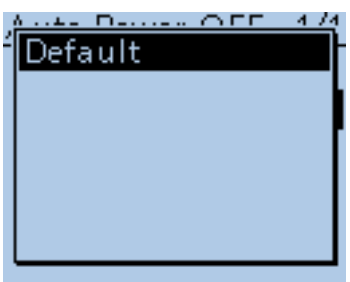

## Menu items and Default settings

**NOTE:** The default settings shown below are for the USA version.  
 The default settings may differ, depending on your transceiver version.

DUP/TONE...		In this item, set the <b>repeater duplex</b> offset and the channel tone or code options.	
	RANGE OR VALUE (Default is shown in bold)	DESCRIPTIONS	
Offset Freq	0.000~ <b>0.600.00</b> *~59.995	Sets the <b>frequency offset</b> for duplex (repeater) operation.	
Repeater Tone	67.0~ <b>88.5</b> ~254.1	Selects the tone frequency used to access the repeaters.	
TSQL Freq	67.0~ <b>88.5</b> ~254.1	Selects the tone frequency for the Tone squelch or the pocket beep function.	
Tone Burst	<b>OFF</b> or ON	Turns the Tone Burst function ON or OFF. When this setting is ON and you transmit a signal which superimposes the CTCSS tone or subaudible tone, the squelch tail noise of FM mode is suppressed on the RX side.	
DTCS Code	<b>023</b> ~754	Selects DTCS (both encoder/decoder) codes for DTCS squelch or the pocket beep function.	
DTCS Polarity	<b>Both N</b> , TN-RR, TR-RN or Both R	Selects the DTCS polarity for the DTCS squelch or the pocket beep function.	
Digital Code	<b>00</b> ~99	Selects the digital code for the Digital Code squelch function.	

\* The default value may differ, depending on the frequency band (selected as the Main band before entering the Menu screen) and the transceiver version.

Scan		In this item, set the scan options.	
	RANGE OR VALUE (Default is shown in bold)	DESCRIPTIONS	
Pause Timer	2sec~ <b>10sec</b> ~20sec or HOLD	Selects the scan pause time. When receiving signals, the scan pauses according to the scan pause timer.	
Resume Timer	0sec~ <b>2sec</b> ~5sec or HOLD	Selects the scan resume time from a pause after the received signal disappears.	
Temporary Skip Timer	<b>5min</b> , 10min or 15 min	Selects the Temporary Skip Time. When the time is set, specified frequencies are skipped for this period during a scan.	
Program Skip	OFF or <b>ON</b>	Turns the Program Skip Scan function ON or OFF for a VFO mode scan.	
Bank Link	A: <input checked="" type="checkbox"/> ~Z: <input checked="" type="checkbox"/>	Selects banks to be scanned during a Bank Link Scan.	
Program Link*		Sets the link function for the program scan edge channels.	

\* See page 16-20 for details of the preset values.

# 16 MENU SCREEN

## ■ Menu items and Default settings (Continued)

**NOTE:** The default settings shown below are for the USA version.  
 The default settings may differ, depending on your transceiver version.

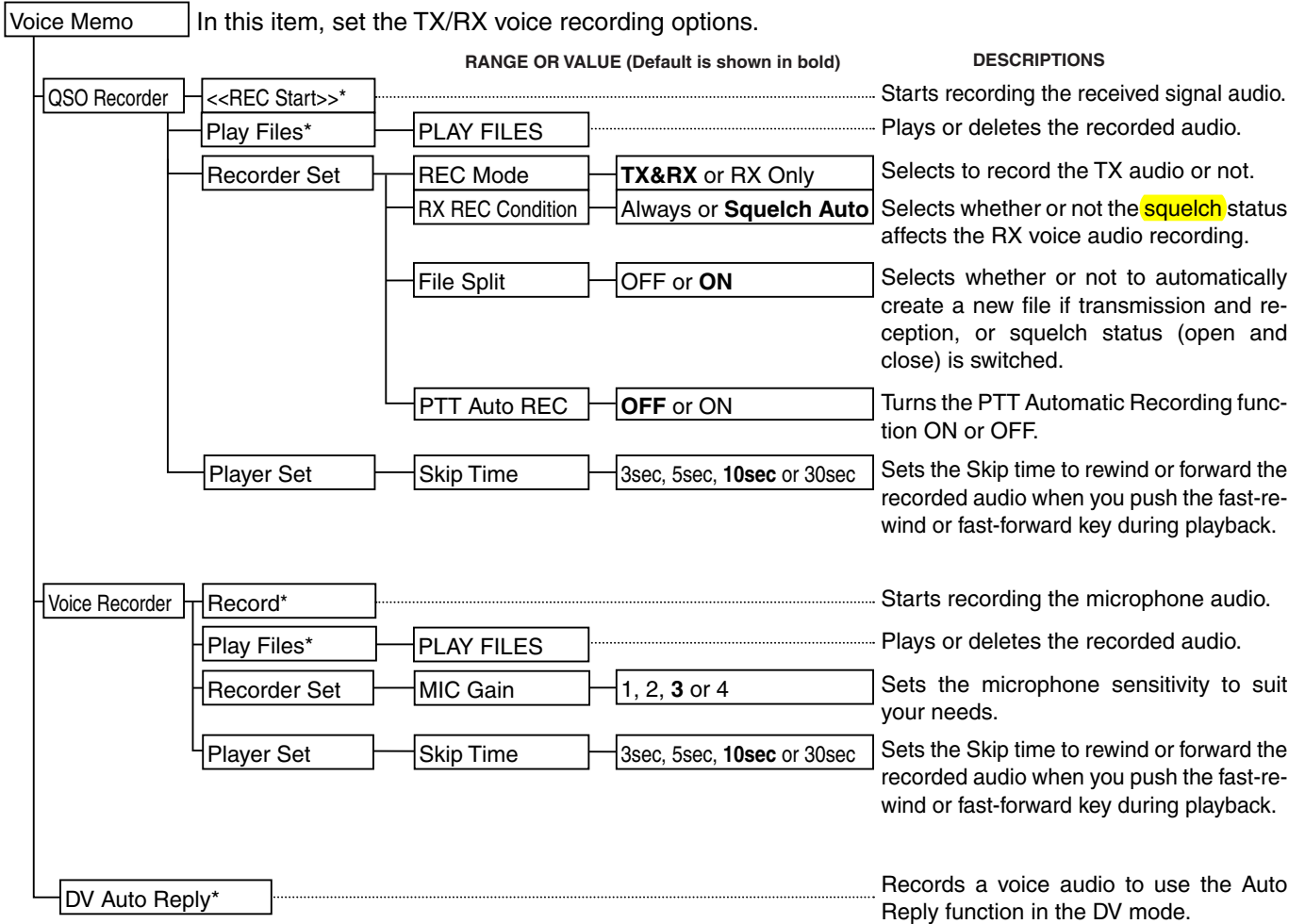

\* Be sure to insert the microSD card into the transceiver before selecting these items.

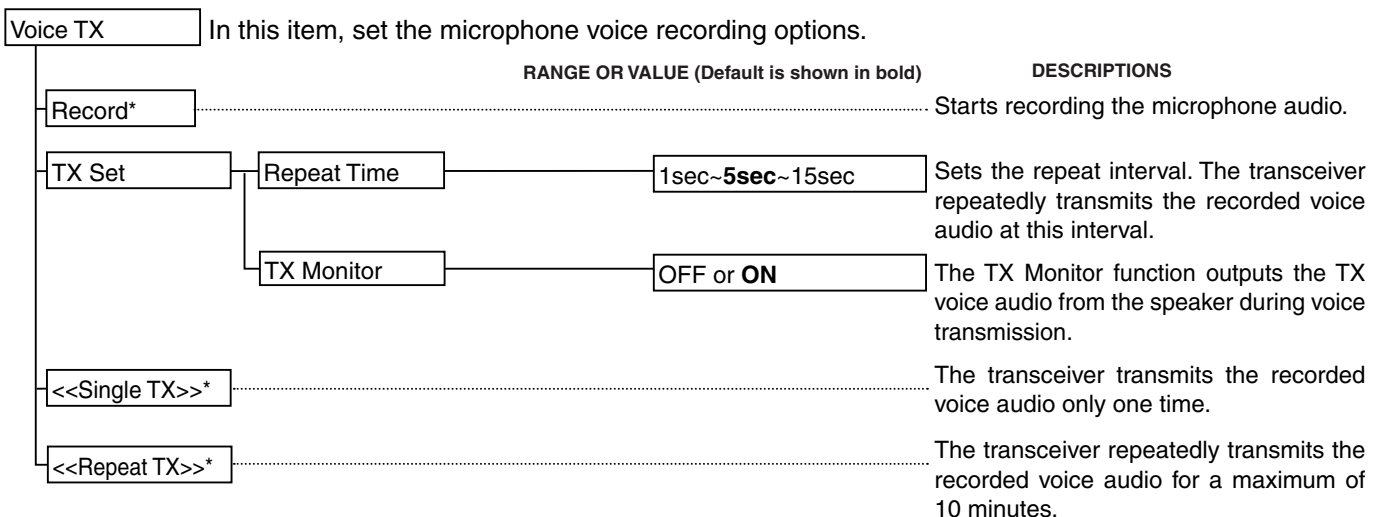

\* Be sure to insert the microSD card into the transceiver before selecting these items.

■ Menu items and Default settings (Continued)

/// **NOTE:** The default settings shown below are for the USA version.  
 /// The default settings may differ, depending on your transceiver version.

BC Radio		In this item, set the Broadcast (BC) Radio options.		
			RANGE OR VALUE (Default is shown in bold)	DESCRIPTIONS
BC Radio Memory				Shows the BC Radio memory contents.
BC Radio Set	Auto Mute		OFF, 0sec~ <b>2sec</b> ~10sec	Sets the timer to automatically mute the BC Radio audio.
	FM Antenna		<b>External</b> or Earphone	Selects the desired antenna for FM.
	Power Save (BC Radio)		OFF or <b>ON</b>	Turns the Power Save (BC Radio) function ON (to save battery power) or OFF.
<<BC Radio ON>>/<<BC Radio OFF>>				Turns the BC Radio ON or OFF.
<<BC Radio Mode>>				Selects the BC Radio Mode with the transceiver in the Sleep mode.

■ Menu items and Default settings (Continued)

/// **NOTE:** The default settings shown below are for the USA version.  
 /// The default settings may differ, depending on your transceiver version.

GPS		In this item, set the GPS options.	
		RANGE OR VALUE (Default is shown in bold)	DESCRIPTIONS
GPS Set	GPS Select	<b>OFF</b> , Internal GPS, External GPS or Manual	Selects the GPS receiver that the transceiver receives its position data from.
	Power Save (Internal GPS)	OFF, 1min, 2min, 4min, 8min or <b>Auto</b>	Selects the internal GPS receiver power save function.
	Manual Position		Manually enter your current position.
	GPS Indicator	OFF or <b>ON</b>	Turns the GPS indicator ON or OFF.
	Position Format	<b>ddd°mm.mm'</b> or ddd°mm'ss"	Selects position format to display the position.
	Altitude/Distance Units	m or <b>ft/ml</b>	Selects units to display the distance and altitude.
	Speed Units	km/h, <b>mph</b> or knots	Selects units to display the speed.
	GPS Out	<b>OFF</b> or ON	Turns the output of GPS information from the internal GPS receiver to the [DATA] jack ON or OFF.
GPS Information		Displays the received GPS information.	
GPS Position		Displays your position, RX station, GPS memory and Alarm positions.	
GPS Memory		Shows the GPS memory contents.	
GPS Alarm	Alarm Select	<b>OFF</b> , RX, Group or Memory	Select the target for the GPS alarm function.
	Alarm Area (Group)	0'05"/0.08'~ <b>0'15"/0.25'</b> ~ 59'59"/59.99'	Enter the GPS alarm active range.
	Alarm Area (RX/Memory)	Limited, Extended or <b>Both</b>	Select the GPS alarm active range.
GPS Logger*	GPS Logger	<b>OFF</b> or ON	Turns the GPS logger function ON or OFF, to store your route as you move.
	Record Interval	1sec, <b>5sec</b> , 10sec, 30sec or 60sec	Selects the GPS Logger function record interval.
	<<GPS Logger Only>>		Turns ON the GPS logger function with the transceiver in the Sleep mode.

\* Be sure to insert the microSD card into the transceiver before selecting these items.

(Continued on the next page.)



■ Menu items and Default settings (Continued)

/// **NOTE:** The default settings shown below are for the USA version.  
 /// The default settings may differ, depending on your transceiver version.

GPS (Continued) In this item, set the GPS options.

	RANGE OR VALUE (Default is shown in bold)	DESCRIPTIONS
GPS TX Mode		Select GPS or DPS-A as the data mode when transmitting GPS data, or select OFF.
<b>OFF</b>		Turns OFF the GPS TX function.
GPS(DV-G)		
GPS Sentence	RMC, <b>GGA</b> , GLL, VTG, GSA or GSV	Transmits position data in selected GPS sentences.
GPS Message		Enter a GPS message to be transmitted.
GPS-A(DV-A)		
Unproto Address	<b>API51,DSTAR*</b>	Enters an unproto address, or keep the default.
Data Extension	<b>OFF</b> or Course/Speed	Selects whether to transmit the course and speed data or not.
Time Stamp	<b>OFF</b> , DHM or HMS	Selects a format to transmit the current <b>UTC</b> time as a time stamp.
Altitude	<b>OFF</b> or ON	Turns the altitude transmit option ON or OFF.
GPS-A Symbol	<b>1:Person</b> , 2:Bicycle, 3:Car or 4:House QTH (VHF)	Selects a desired GPS-A Symbol to transmit.
SSID	<b>- - -</b> , (-0), -1~-15 or -A~-Z	Selects the <b>APRS</b> ® call sign SSID.
Comment		Enters a comment to transmit.
GPS Auto TX	<b>OFF</b> , 5sec, 10sec, 30sec, 1min, 3min, 5min, 10min or 30min	Selects a time option for the GPS automatic transmission function.

## 16 MENU SCREEN

### ■ Menu items and Default settings (Continued)

/// **NOTE:** The default settings shown below are for the USA version.  
 /// The default settings may differ, depending on your transceiver version.

Call Sign	In this item, set and display the call signs used in the DV mode.	DESCRIPTIONS
UR: CQCQCQ, R1: -----, R2: -----, MY: -----		Displays the operating call signs. Sets the operating call signs according to the type of call you want to make.

RX History	This item displays the received call history in the DV mode.	DESCRIPTIONS
RX01:		Displays the calls your transceiver received.

DV Memory	This item stores Your Call signs or <b>repeater</b> information to use in the DV mode.	DESCRIPTIONS
Your Call Sign	Blank	Stores station call signs. Add or edit a call sign.
Repeater List*	01:~25:	Stores repeater information. Add or edit a repeater information.

\* See page 9-44 for details of the preloaded data.

/// **NOTE:** The repeater list described on this manual may differ from your preloaded list.

My Station	This item stores your own call sign to use in the DV mode.	RANGE OR VALUE (Default is shown in bold)	DESCRIPTIONS
My Call Sign		<b>1</b> :~6:	Stores your own call signs. Select or edit a call sign to use in the DV mode.
TX Message		1:~5: or <b>OFF</b>	Stores TX Messages. Select or edit TX Message to use in the DV mode.

■ Menu items and Default settings (Continued)

/// **NOTE:** The default settings shown below are for the USA version.  
 /// The default settings may differ, depending on your transceiver version.

DV Set		In this item, set infrequently changed values or functions in the DV mode.	
		RANGE OR VALUE (Default is shown in bold)	DESCRIPTIONS
Tone Control	RX Bass	Cut, <b>Normal</b> or Boost	Sets the DV mode received audio bass filter level to Cut, Normal or Boost.
	RX Treble	Cut, <b>Normal</b> or Boost	Sets the DV mode received audio treble filter level to Cut, Normal or Boost.
	RX Bass Boost	<b>OFF</b> or ON	Turns the DV mode received audio Bass Boost function ON or OFF
	TX Bass	Cut, <b>Normal</b> or Boost	Sets the DV mode transmit audio bass filter level to Cut, Normal or Boost.
	TX Treble	Cut, <b>Normal</b> or Boost	Sets the DV mode transmit audio treble filter level to Cut, Normal or Boost.
Auto Reply	<b>OFF</b> , ON, Voice or Position		Selects the Automatic Reply function between ON, OFF, Voice and Position.
DV Data TX	PTT or <b>Auto</b>		Selects manually or automatically to transmit low speed data.
Digital Monitor	<b>Auto</b> , Digital or Analog		Selects the DV mode RX monitoring when [SQL] is held down.
Digital Repeater Set	<b>OFF</b> or <b>ON</b>		Turns the digital <b>repeater</b> setting function ON or OFF. This function is usable in any DV mode except the DR mode.
RX Call Sign Write	<b>OFF</b> or Auto		Turns the RX call sign automatic write function ON or OFF. This function is usable in any DV mode except the DR mode.
RX Repeater Write	<b>OFF</b> or Auto		Turns the repeater call sign automatic write function ON or OFF. This function is usable in any DV mode except the DR mode.
DV Auto Detect	<b>OFF</b> or ON		Turns the DV mode automatic detect function ON or OFF.
RX Record (RPT)	<b>ALL</b> or Latest Only		The transceiver can record the data of up to 50 individual calls.
BK	<b>OFF</b> or ON		Turns the BK (Break-in) function ON or OFF. The BK function allows you to break into a conversation between two stations with call sign squelch enabled.
EMR	<b>OFF</b> or ON		Turns the EMR (Enhanced Monitor Request) communication mode ON or OFF. After turning OFF the transceiver, the EMR mode will be cancelled.
EMR AF Level	0~ <b>19</b> ~39		Sets the audio output level when an EMR mode signal is received.

## 16 MENU SCREEN

### ■ Menu items and Default settings (Continued)

/// **NOTE:** The default settings shown below are for the USA version.  
 /// The default settings may differ, depending on your transceiver version.

SPEECH		In this item, set the Speech functions.	
	RANGE OR VALUE (Default is shown in bold)		DESCRIPTIONS
RX Call Sign SPEECH	OFF, <b>ON (Kerchunk)</b> or ON (All)		Selects the RX call sign speech function option while ON, or turn it OFF.
RX>CS SPEECH	OFF or <b>ON</b>		Turns the RX>CS Speech function ON or OFF.
DIAL SPEECH	<b>OFF</b> or ON		Turn the Dial Speech function ON or OFF.
MODE SPEECH	<b>OFF</b> or ON		Turn the Operating Mode Speech function ON or OFF.
SPEECH Language	<b>English</b> or Japanese		Selects either English or Japanese as the desired speech language.
Alphabet	<b>Normal</b> or Phonetic Code		Selects the alphabet character announcement type.
SPEECH Speed	Slow or <b>Fast</b>		Selects Slow or Fast speech speed
SPEECH Level	0~7~9		Sets the volume level for the voice synthesizer.

DTMF/T-CALL		In this item, set the <b>DTMF</b> Memory functions.	
DTMF Memory	T-CALL, <b>d0</b> :~d9:, dA:~dD:, d*: or d#:		Shows a list of the DTMF memory channels. The DTMF memory can store up to 24-digit DTMF code.
DTMF Speed	<b>100ms</b> , 200ms, 300ms or 500ms		Selects the DTMF transfer speed.

QSO/RX Log		In this item, set the QSO/RX History Log options.	
QSO Log* <sup>1</sup>	<b>OFF</b> or ON		Selects to make a communication log on the microSD card, or not.
RX History Log* <sup>1</sup>	<b>OFF</b> or ON		Selects to make a DV mode's receive history log on the microSD card, or not.
CSV Format			
Separator/Decimal	<b>Sep [,]</b> Dec [.] <sup>*2</sup> , Sep [;] Dec [.] or Sep [:] Dec [.]		Selects the separator and the decimal character for the CSV format.
Date	yyyy/mm/dd, <b>mm/dd/yyyy</b> <sup>*2</sup> or dd/mm/yyyy		Selects the date format.

\*<sup>1</sup> Be sure to insert the microSD card into the transceiver before selecting these items.

\*<sup>2</sup> The default value may differ, depending on the transceiver version.

# 16 MENU SCREEN

## ■ Menu items and Default settings (Continued)

/// **NOTE:** The default settings shown below are for the USA version.  
 /// The default settings may differ, depending on your transceiver version.

Function	In this item, set other options.	RANGE OR VALUE (Default is shown in bold)	DESCRIPTIONS
Power Save		OFF, <b>Auto (Short)</b> , Auto (Middle) or Auto (Long)	Selects the Power Save options to reduce current drain and conserve battery power.
Monitor		<b>Push</b> or Hold	Selects the [SQL] monitor function method.
Dial Speed-UP		OFF or <b>ON</b>	Turns the dial speed acceleration ON or OFF.
Auto Repeater		OFF or <b>ON (DUP)</b> , ON (DUP,TONE)	Turns the Auto <b>Repeater</b> function ON or OFF.
Remote MIC Key	During RX/Standby	[A]:BAND [B]:VFO/MR [Δ]:UP [▽]:DOWN	Selects the key function to be used while receiving or in the standby mode.
	During TX	[A]:T-CALL [B]:- [Δ]:- [▽]:-	Selects the key functions to be used while transmitting.
Key Lock		<b>Normal</b> , No SQL, No VOL or ALL	Selects the key lock type when the Key Lock function is turned ON.
PTT Lock		<b>OFF</b> or ON	Turns the PTT Lock function ON or OFF.
Busy Lockout		<b>OFF</b> or ON	Turns the Busy Lockout function ON or OFF.
Time-Out Timer		OFF, 1min, 3min, <b>5min</b> , 10min, 15min or 30min	Selects the Time-Out Timer time options.
Active Band		Single or <b>All</b>	Allows continuous frequency selection across all bands by rotating [DIAL].
MIC Gain (Internal)		1~2~4	Sets the internal microphone sensitivity to suit your preference.
MIC Gain (External)		1~2~4	Sets the external microphone sensitivity to suit your preference.
Data Speed		4800bps or <b>9600bps</b>	Selects the data transmission speed for low-speed communication, or between the [DATA] jack and external modules like a GPS receiver, and so on.
VOX	VOX	<b>OFF</b> or ON	Turns the VOX function ON or OFF.
	VOX Level	1~5~10 or OFF	Sets the VOX gain level.
	VOX Delay	<b>0.5sec</b> , 1.0sec, 1.5sec, 2.0sec, 2.5sec or 3.0sec	Sets the VOX Delay time.
	VOX Time-Out Timer	OFF, 1min, 2min, <b>3min</b> , 4min, 5min, 10min or 15min	Sets the VOX Time-Out Timer to prevent an accidental prolonged transmission.
	Headset Select	HS-95 or <b>Other</b>	Selects the headset type to be used for the VOX function to limit the maximum audio output level to protect the headset speaker.
CI-V	CI-V Address	01~ <b>86</b> ~DF	Sets the transceiver's unique CI-V hexadecimal address code.
	CI-V Baud Rate	300, 1200, 4800, 9600, 19200 or <b>Auto</b>	Sets the CI-V code transfer speed.
	CI-V Transceive	<b>OFF</b> or ON	Turns the CI-V Transceive function ON or OFF.

## 16 MENU SCREEN

### ■ Menu items and Default settings (Continued)

/// **NOTE:** The default settings shown below are for the USA version.  
 /// The default settings may differ, depending on your transceiver version.

Function (Continued) In this item, set other options.

	RANGE OR VALUE (Default is shown in bold)	DESCRIPTIONS
Heterodyne	<b>Normal</b> or Reverse	Sets the 1st Local Oscillator frequency.
Charging (Power ON)	<b>OFF</b> or ON	When the external DC power cable is connected, this function enables charging the battery even with the power ON.

Display In this item, set the Display options.

	RANGE OR VALUE (Default is shown in bold)	DESCRIPTIONS
Backlight	OFF, ON, Auto or <b>Auto (DC IN:ON)</b>	Selects the transceiver backlight option.
Backlight Timer	<b>5sec</b> or 10sec	Selects the backlight ON time period.
LCD Dimmer	<b>Bright</b> or Dark	Selects the LCD backlight brightness level
LCD Contrast	1~ <b>8</b> ~16	Sets the contrast level of the LCD.
Busy LED	OFF or <b>ON</b>	Turns the TX/RX indicator ON or OFF.
RX Call Sign	OFF, <b>Auto</b> or Auto (RX Hold)	Selects the call sign display option when receiving a call.
RX Message	OFF or <b>Auto</b>	Selects to display and scroll a received message when receiving a call, or not.
Reply Position Display	OFF or <b>ON</b>	Selects to display the caller's position data when the data is included in the Auto Reply signal, or not.
DV RX Backlight	OFF or <b>ON</b>	Turns the DV RX Backlight function ON or OFF.
TX Call Sign	OFF, <b>Your Call Sign</b> or My Call Sign	Selects whether or not to display My or Your call sign while transmitting.
Scroll Speed	Slow or <b>Fast</b>	Selects the scrolling speed of the message, call sign, or other text.
Opening Message	OFF or <b>ON</b>	Selects whether or not to display the opening message at power ON.
Voltage (Power ON)	OFF or <b>ON</b>	Selects whether or not to display the voltage of the battery or external DC power source at power ON.
Display Language	<b>English</b> or Japanese	Selects the display language in the DR mode or Menu mode. When "English" is selected in System Language, this setting will disappear.
System Language	<b>English</b> or Japanese	Selects English or Japanese as the system language of the transceiver.

■ Menu items and Default settings (Continued)

/// **NOTE:** The default settings shown below are for the USA version.  
 /// The default settings may differ, depending on your transceiver version.

Sounds		In this item, set the Sound options.		DESCRIPTIONS
			RANGE OR VALUE (Default is shown in bold)	
Volume Select			<b>All</b> , BC Radio Separate or Separate	Selects to adjust the audio output level of all bands together, all separately, or just the BC Radio separately.
BC Radio Level			-5~ <b>0</b> ~+5	Sets the initial audio output level difference between the BC Radio and the A and B bands when "All" is set in "Volume Select."
Earphone Mode			<b>OFF</b> or ON	Turns the Earphone mode ON or OFF.
Beep Level			0~ <b>3</b> ~9	Sets the beep output level.
Beep/Vol Level Link			<b>OFF</b> or ON	Selects whether or not the beep output level can be adjusted by the [VOL] control.
Key-Touch Beep			OFF or <b>ON</b>	Turns the confirmation beep tones when key is pushed, ON or OFF.
Home CH Beep			OFF or <b>ON</b>	Turns the Home CH Beep ON or OFF.
Band Edge Beep			<b>OFF</b> or ON	Turns the Band edge beep ON or OFF.
Scan Stop Beep			<b>OFF</b> or ON	Turns the scan stop beep ON or OFF.
Standby Beep			OFF, <b>ON</b> or ON (to me:High Tone)	Turns the standby beep function in the DV mode ON or OFF.
Sub Band Mute			<b>OFF</b> , Mute, Beep or Mute & Beep	Selects to mute the SUB band audio signal while receiving on the MAIN band, and/or sound a beep when a signal disappears on the SUB band.
Scope AF Output			OFF or <b>ON</b>	Selects the audio output option during a sweep.

Time Set		In this item, set the Time options.		DESCRIPTIONS
Date/Time				Sets the current date and time.
GPS Time Correct			OFF or <b>Auto</b>	Sets to automatically correct the time using a GPS signal.
UTC Offset			-14:00~ <b>±0:00</b> ~+14:00	Enters the time difference between <b>UTC</b> and the local time.
Auto Power OFF			<b>OFF</b> , 30min, 60min, 90min or 120min	Turns the Auto power OFF function ON or OFF.

SD Card*		In this item, set the microSD card options.		DESCRIPTIONS
			RANGE OR VALUE (Default is shown in bold)	
Load Setting	File selection		<b>ALL</b> , Except My Station, Repeater List Only	Loads the settings file to the transceiver.
Save Setting	<<New File>>			Saves the settings as a new file.
	File selection			Saves the settings in a selected file.
SD Card Info				Displays the free space and remaining recording time of the card.
Format				Formats the card.
Unmount				Unmounts the card.

\* Be sure to insert the microSD card into the transceiver before selecting these items.

■ Menu items and Default settings (Continued)

/// **NOTE:** The default settings shown below are for the USA version.  
 /// The default settings may differ, depending on your transceiver version.

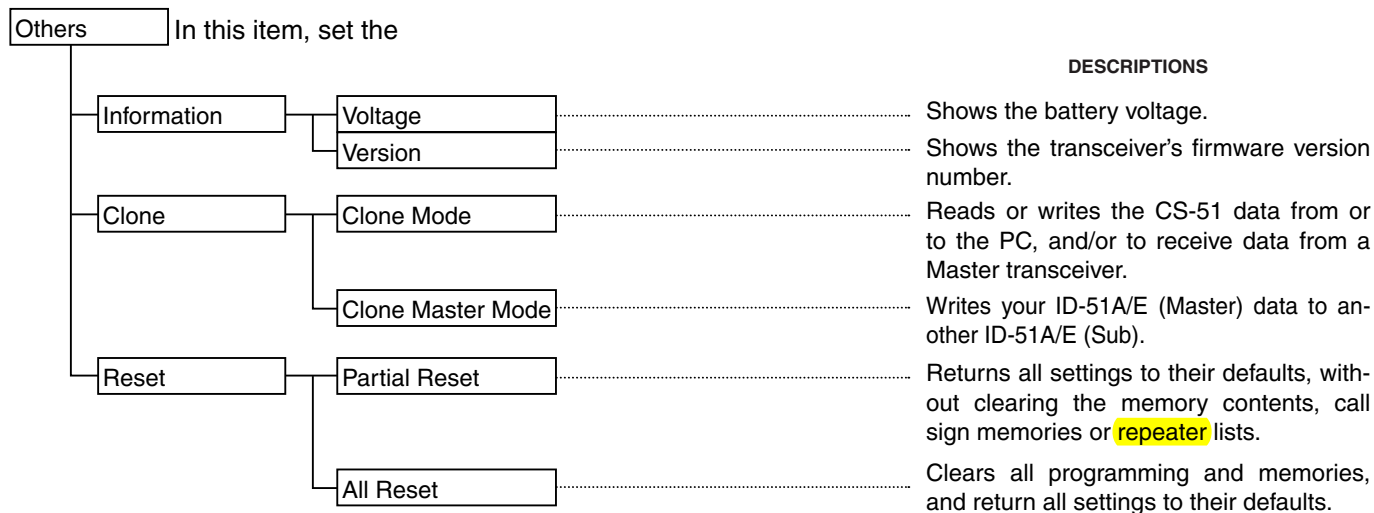



## ■ DUP/TONE items

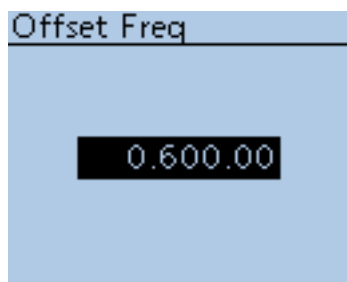

### Offset frequency (Default: 0.600.00\*)

DUP/TONE... > Offset Freq (Offset Freq)

Set the frequency offset for **duplex** (repeater) operation to between 0 and 59.99500 MHz.

- The selected tuning step in the VFO mode is used when setting the offset.
- Push [V/MHz] (V/MHz CLR LOW) to select 1 MHz or 10 MHz steps.
- The duplex shift direction (DUP-/DUP+) is set in the QUICK MENU screen. (p. 15-5)

\*The default value may differ, depending on the frequency band (selected as the Main band before entering the Menu screen) and the transceiver version.

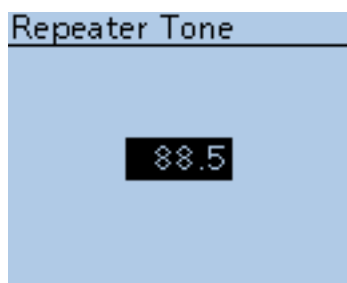

### Repeater Tone (Default: 88.5)

DUP/TONE... > Repeater Tone (Repeater Tone)

Select subaudible tone frequencies, for **repeater** access and other functions. 50 tone frequencies (67.0–254.1 Hz) are selectable.

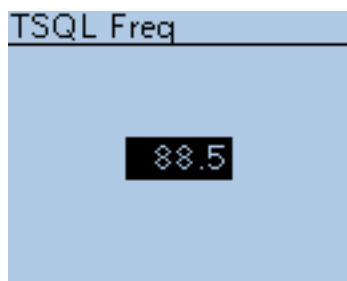

### TSQL Freq (Default: 88.5)

DUP/TONE... > TSQL Freq (TSQL Freq)

Select the tone frequency for the tone squelch or pocket beep. 50 frequencies (67.0–254.1 Hz) are selectable.

• **Selectable repeater tone/tone squelch frequencies** (Unit: Hz)

67.0	85.4	107.2	136.5	165.5	186.2	210.7	254.1
69.3	88.5	110.9	141.3	167.9	189.9	218.1	
71.9	91.5	114.8	146.2	171.3	192.8	225.7	
74.4	94.8	118.8	151.4	173.8	196.6	229.1	
77.0	97.4	123.0	156.7	177.3	199.5	233.6	
79.7	100.0	127.3	159.8	179.9	203.5	241.8	
82.5	103.5	131.8	162.2	183.5	206.5	250.3	

/// The transceiver has 50 tone frequencies and consequently their spacing is narrow compared with units having 38 tones. Therefore, some tone frequencies may receive interference from adjacent tone frequencies.

■ DUP/TONE items (Continued)

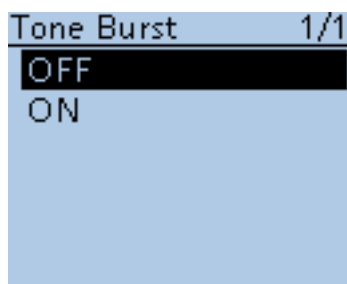

**Tone Burst** (Default: OFF)

DUP/TONE... > Tone Burst (Tone Burst)

Turn the Tone Burst function ON or OFF in the FM mode when using tone squelch.

- OFF : When you transmit a signal that superimposes the CTCSS tone, the other station may hear a short burst of noise from their receiver, just after you stop transmitting.
- ON : When you transmit a signal that superimposes the CTCSS tone, the function mutes the noise from being heard in the other station's receiver.

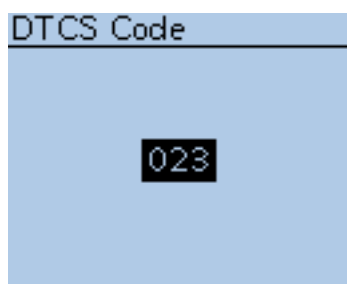

**DTCS Code** (Default: 023)

DUP/TONE... > DTCS Code (DTCS Code)

Select a DTCS (both encoder/decoder) code for the DTCS squelch. A total of 104 codes (023–754) are selectable.

• **Selectable DTCS codes**

023	072	152	244	311	412	466	631
025	073	155	245	315	413	503	632
026	074	156	246	325	423	506	654
031	114	162	251	331	431	516	662
032	115	165	252	332	432	523	664
036	116	172	255	343	445	526	703
043	122	174	261	346	446	532	712
047	125	205	263	351	452	546	723
051	131	212	265	356	454	565	731
053	132	223	266	364	455	606	732
054	134	225	271	365	462	612	734
065	143	226	274	371	464	624	743
071	145	243	306	411	465	627	754

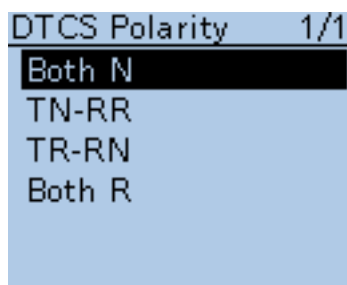

**DTCS Polarity** (Default: Both N)

DUP/TONE... > DTCS Polarity (DTCS Polarity)

Select the DTCS polarity to use for transmitting and receiving.

- Both N : Normal polarity is used for both TX and RX.
- TN-RR : Normal polarity is used for TX; Reverse polarity for RX.
- TR-RN : Reverse polarity is used for TX; Normal polarity for RX.
- Both R : Reverse polarity is used for both TX and RX.

DTCS code's polarity for transmitting or receiving can be independently set with this item.

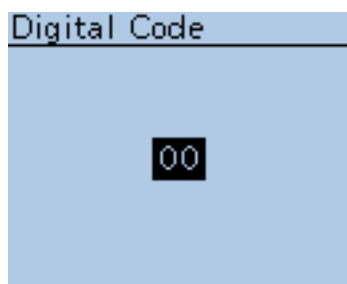

**Digital Code** (Default: 00)

DUP/TONE... > Digital Code (Digital Code)

Select the desired digital code for digital code squelch. A total of 100 codes (00–99) are selectable.

## ■ Scan items

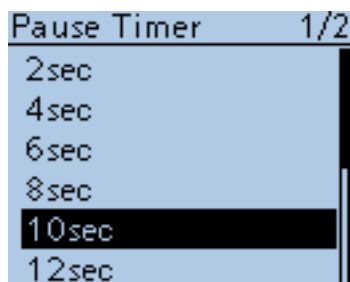

### Pause Timer

(Default: 10sec)

Scan > Pause Timer (Pause Timer)

Select the scan Pause time. When receiving a signal, the scan pauses for the scan Pause timer Time.

- 2 to 20sec : When a signal is received, the scan pauses for 2 to 20 seconds (set in 2 seconds steps).
- HOLD : When receiving a signal, the scan pauses until it disappears.

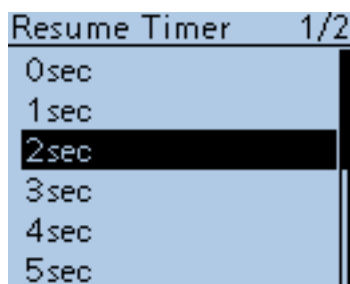

### Resume Timer

(Default: 2sec)

Scan > Resume Timer (Resume Timer)

Select the scan Resume Timer time.

When a received signal disappears, the scan resumes according to the scan Resume Timer setting.

- 0sec : The scan resumes immediately after the signal disappears.
- 1 to 5sec : The scan resumes 1 to 5 seconds after the signal disappears.
- HOLD : The scan remains paused for the Pause Timer setting, even if the signal disappears.

/// **NOTE:** Rotate [DIAL] to resume the scan.

/// The Resume Timer must be set shorter than the Pause Timer, otherwise this timer does not work properly.

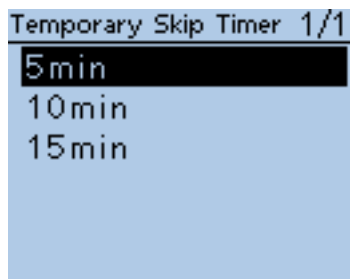

### Temporary Skip Timer

(Default: 5min)

Scan > Temporary Skip Timer (Temporary Skip Timer)

Set the Temporary Skip Timer to 5, 10 or 15 minutes.

When the time is set, the specified frequencies are skipped for this set period during a scan.

■ Scan items (Continued)

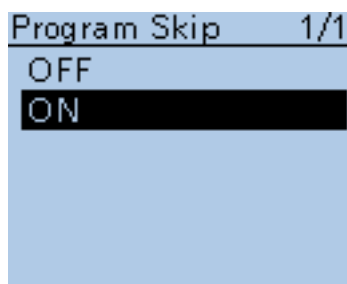

**Program Skip** (Default: ON)

Scan > Program Skip (Program Skip)

Turn the Program Skip Scan function ON or OFF for a VFO mode scan. This function enables the transceiver to skip the unwanted frequencies or channels that inconveniently stop scanning. Set the unwanted frequencies or channels to “PSKIP” in the Memory Channel screen.

- OFF : The transceiver scans all frequencies without skipping.
- ON : The transceiver does not scan frequencies set as “PSKIP” frequencies.

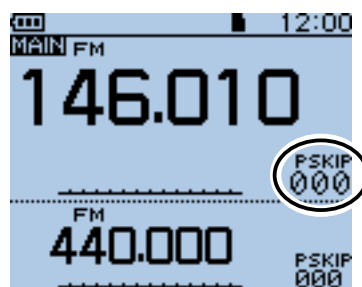

When the skip setting is ON “PSKIP” appears on the channel number.

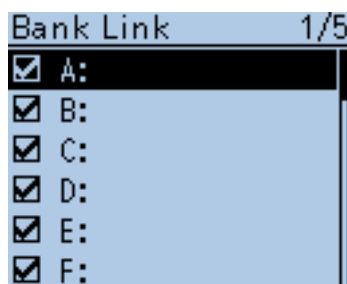

**Bank Link** (Default: A:☑ – Z:☑)

Scan > Bank Link (Bank Link)

Select banks to be scanned during a Bank Link Scan. The Bank Link function scans all channels in the selected banks. Select a desired bank, A to Z, and then push D-pad(Ent) to turn the link ON or OFF.

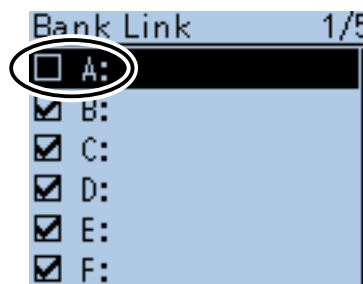

Set Bank A to OFF.

■ Scan items (Continued)

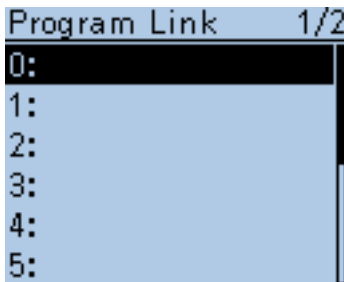

**Program Link** (Default: Refer to the diagram below)

Scan > Program Link (Program Link)

This item sets the link function for more than two pair of Program Scan Edge channels to be sequentially scanned during the Program Link Scan. The link function scans all frequencies in the scan range.

**Default settings of the Program Link**

The Program Scan Edge channels "01" and "02" are set in the Program Link number "0" as the Default.

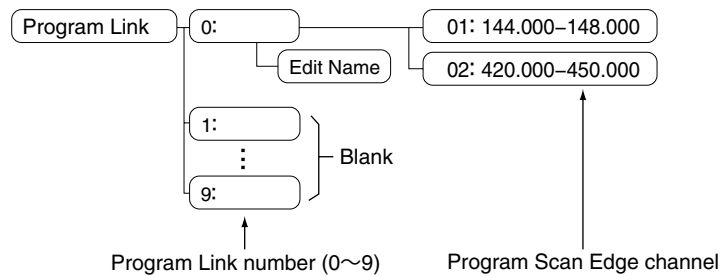

- The Program Link number screen shows the frequency range. (The scan edge frequency may differ, depending on the transceiver version.)
- A link setting can be added when more than two pairs of Program Scan Edge channels are programmed. (p. 13-2)

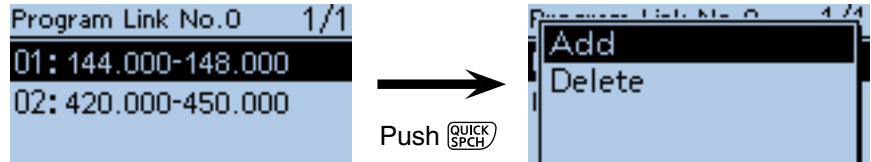

Program Link number screen

**NOTE:** The "Add" item will not be displayed when only one pair of programmed scan edge channels are programmed, or no programmed scan channel (00 to 24) is left to add to the selected link channel.

**Adding a Scan Edge channel to the Program Link**

- ① Push D-pad(↑) to select a Program Link number between 0 and 9, where you wish to add a Scan Edge channel, and then push D-pad(Ent).

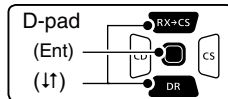

- ② Push [QUICK] [QUICK SPCH].
- ③ Push D-pad(↑) to select "Add," and then push D-pad(Ent).

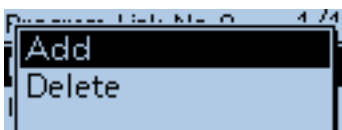

- ④ Push D-pad(↑) to select a programmed scan number you wish to assign to the selected link channel, and then push D-pad(Ent).  
(For example: 00: 144.000-450.000)
- ⑤ Push [MENU] [MENU] to exit the [MENU] screen.

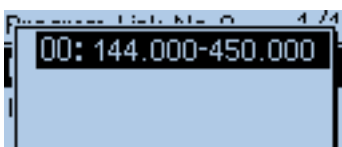

■ Scan items (Continued)

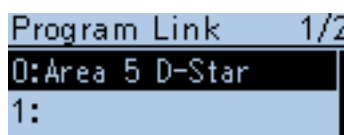
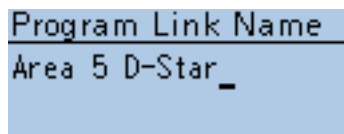
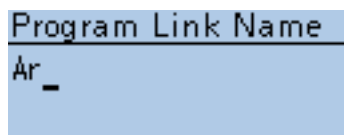
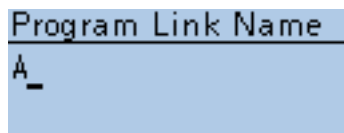
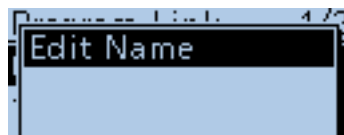
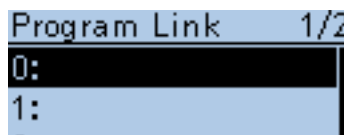
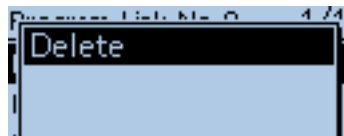
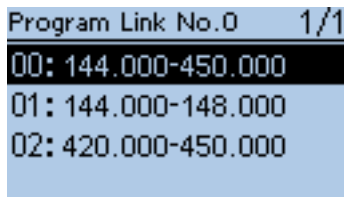

**Deleting the link channel**

- ① Push D-pad(↑) to select the programmed scan link number that the channel you wish to delete is assigned to, and then push D-pad(Ent).

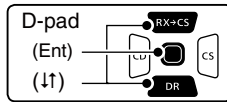

- ② Push D-pad(↑) to select programmed scan number you wish to delete. (For example: 01: 144.000-450.000)
- ③ Push [QUICK] <sup>QUICK</sup>SPCH.
- ④ Push D-pad(↑) to select "Delete," and then push D-pad(Ent).
  - The channel is deleted.
- ⑤ Push [MENU] <sup>MENU</sup>PRO to exit the Menu screen.

**Program scan link name programming**

- ① Push D-pad(↑) to select a program scan link number between 0 and 9.
- ② Push [QUICK] <sup>QUICK</sup>SPCH.

- ③ Push D-pad(Ent) to enter the name edit mode.

- ④ Rotate [DIAL] to select the first character of the name you wish to program. (For example: A)

- The selected digit blinks.
- Push D-pad(←) to move the cursor backward or forward.
- While selecting a character, push [QUICK] <sup>QUICK</sup>SPCH to change the character to an upper case or lower case letter.
- While selecting a digit, push [QUICK] <sup>QUICK</sup>SPCH to open the input mode selection window.
- A space can be selected in any input mode selected.
- Rotate [DIAL] counter clockwise to enter a space.
- Push [CLR] <sup>CLR</sup>MHZ/LOW to delete the selected character, or hold down [CLR] <sup>CLR</sup>MHZ/LOW to continuously delete the characters, first to the right, and then to the left of the cursor.
- See page 2-7 for programming details.

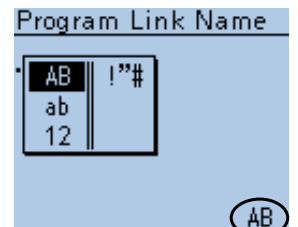

Selected character type

- ⑤ Push D-pad(→) to move the cursor to the second digit.

- ⑥ Repeat steps ④ and ⑤ to enter a name of up to 16 characters, including spaces. (For example: Area 5 D-Star)

- ⑦ After entering the name, push D-pad(Ent) to save.

- ⑧ Push [MENU] <sup>MENU</sup>PRO to exit the [MENU] screen.

## ■ Voice Memo items



### <<REC Start>>

Voice Memo > QSO Recorder > <<REC Start>>

Push D-pad(↑) to select “<<REC Start>>,” and then push D-pad(Ent).

- “Recording started.” appears and voice recording starts.
- “<<REC Stop>>” item is displayed while recording. To stop recording, push D-pad(Ent).

- Be sure to insert a microSD card into the transceiver before selecting these items.
- Once recording has started, the recording will continue, even the transceiver is rebooted.
- To stop the recording, select “<<REC Stop>>” and then push D-pad(Ent).

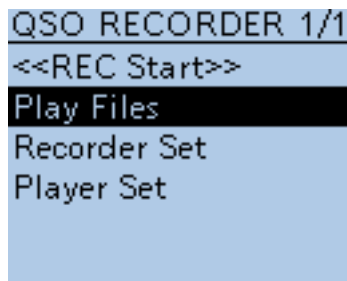

### Play Files

Voice Memo > QSO Recorder > Play Files (PLAY FILES)

Performs the following steps to play back the recorded audio on the microSD card.

Push D-pad(Ent), and folders on the microSD card are displayed.

- These folders contain the stored files.

- Be sure to insert a microSD card into the transceiver before selecting these items.

### Playing back

- ① Push D-pad(↑) to select the folder that includes the desired file to play back, and then push D-pad(Ent).

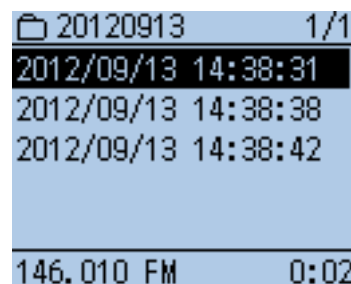
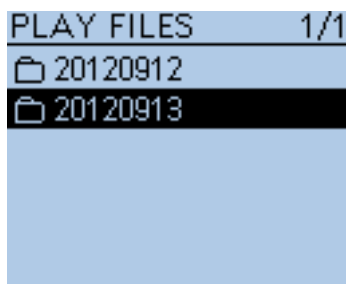
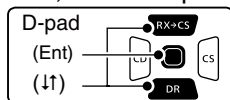

- ② Push D-pad(↑) to select the file to play back, and then push D-pad(Ent).

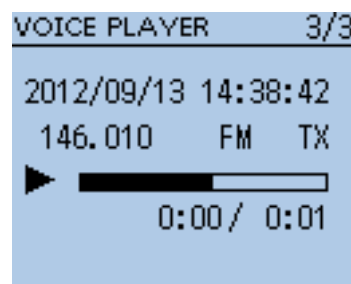
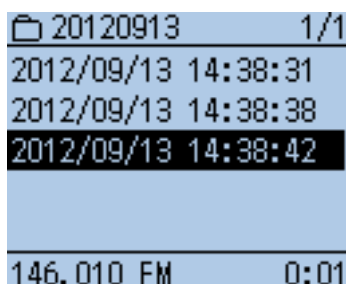

- The VOICE PLAYER screen is displayed and the selected file is played back.
- See “Operation while playing back” for forwarding or rewinding. (p. 11-6)
- ③ Push [MENU] or [CLR] to stop the playback.
- Return to the file list screen.

■ Voice Memo items (Continued)

**NOTE:**

- The folder name is automatically created, as shown in the example below:  
Recording date : 2012/9/1  
Folder name : 20120901
- The file name is automatically created, as shown in the example below:  
Recording date : 2012/9/1 15:30:00  
File name : 20120901\_153000
- The voice audio is recorded onto a microSD card, and saved in the “wav” format.  
The recorded voice audio can also be played back with a PC.  
The extension, “wav,” is not displayed on the transceiver’s screen.

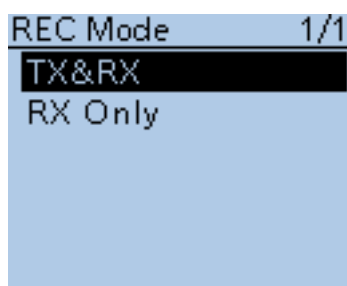

**REC Mode**

**(Default: TX&RX)**

Voice Memo > QSO Recorder > Recorder Set > REC Mode (REC Mode)

Records both the transmitted and received audio as the default setting.

- TX&RX : Records both the transmitted and received voice audio.
- RX Only: Records only the received voice audio.

**When transmitted while recording**

When “OFF” is selected in File Split, the recording is paused. After finishing the transmission, the recording resumes.

When “ON” is selected in File Split, a new file is automatically created, and the transmitted voice audio is recorded into the new one.

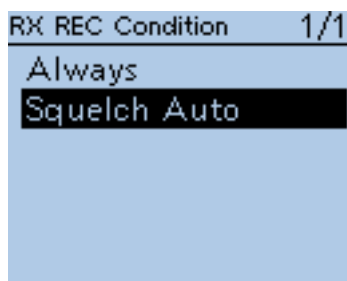

**RX REC Condition**

**(Default: Squelch Auto)**

Voice Memo > QSO Recorder > Recorder Set > RX REC Condition (RX REC Condition)

Select whether or not the **squelch** status affects the RX voice audio recording.

- Always : The transceiver always records the RX voice audio regardless of the squelch status.
- Squelch Auto : The transceiver records the RX voice audio only when a signal is received (the squelch is opened).  
When the squelch closes while recording, the recording will continue for 2 seconds, and then pause.

When “ON” is selected in File Split, and if the squelch either opens or closes while recording, a new file is automatically created.



■ Voice Memo items (Continued)

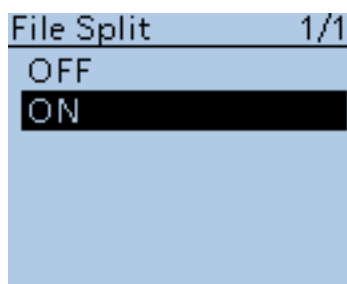

**File Split** (Default: ON)

Voice Memo > QSO Recorder > Recorder Set > File Split (File Split)

Turn the File Split function ON or OFF.

- OFF : When the recording starts, a new file is automatically created in the folder of the microSD card. The voice audio is continuously recorded into the file, even if transmission and reception, or the **sqelch** status (open and close) is switched.  
If the file size exceeds 2 GB, a new file is automatically created in the same folder, and the voice audio is recorded there.
- ON : When the recording starts, a new file is automatically created in the folder of the microSD card. During recording, and if transmission and reception, or squelch status (open and close) is switched, a new file is automatically created in the same folder, and the voice audio is saved into the new one.

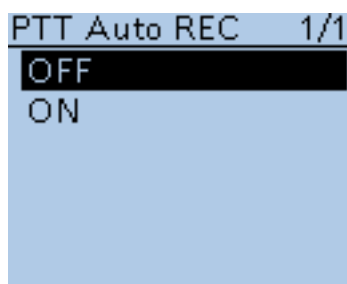

**PTT Auto REC** (Default: OFF)

Voice Memo > QSO Recorder > Recorder Set > PTT Auto REC (PTT Auto REC)

Turn the PTT Automatic Recording function ON or OFF.

The transmission from the external speaker microphone, VOX function and CI-V command also starts recording.

- OFF : Turns the function OFF.
- ON : The recording automatically starts when [PTT] is pushed.  
The recording will stop when:
  - No signal is transmitted for 10 seconds after releasing [PTT].
  - No signal is received for 10 seconds after releasing [PTT].
  - Frequency or operating mode is changed after releasing [PTT].

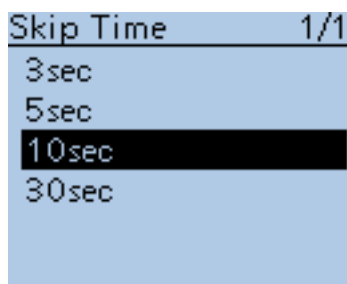

**Skip Time** (Default: 10sec)

Voice Memo > QSO Recorder > Player Set > Skip Time (Skip Time)

Select the SkipTimer to 3, 5, 10 or 30 seconds to rewind or skip forward for this set period when you push the fast-rewind or fast-forward key while playing the recorded voice audio.

- See "Operation while playing back" for forwarding or rewinding operation. (p. 11-6)

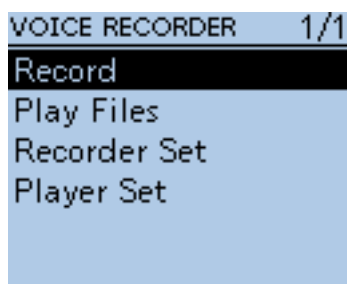

**Record**

Voice Memo > Voice Recorder > Record (VOICE RECORDER)

The microphone audio can be recorded onto a microSD card, and saved in the "wav" format.

While recording a QSO voice audio, this function is disabled.

The QSO voice audio (p. 11-2) and BC radio audio cannot be recorded.

/// Be sure to insert a microSD card into the transceiver before selecting these items.

■ Voice Memo items (Continued)

Record (Continued)

- ① Push [PTT] to start recording.
  - “Recording” appears and the microphone audio recording starts.

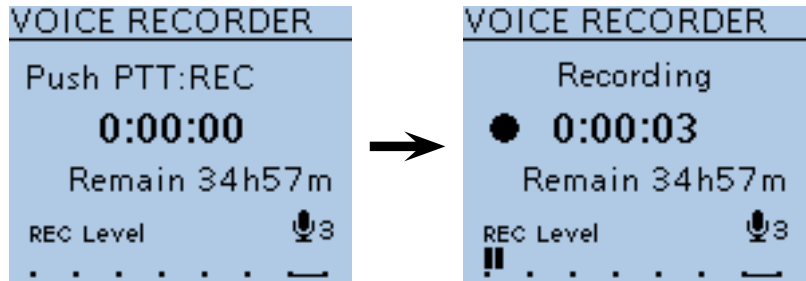

- ② Push [PTT] again to stop.

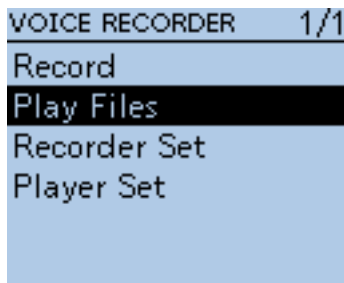

**Play Files**

Voice Memo > Voice Recorder > Play Files (PLAY FILES)

- ➔ Push D-pad(Ent), and folders on the microSD card are displayed.
- These folders contain the stored files.

⚡ Be sure to insert a microSD card into the transceiver before selecting these items.

Do the following steps to play back the recorded audio onto the microSD card.

**Playing back**

- ① Push D-pad(⬆) to select the folder that includes the desired file to play back, and then push D-pad(Ent).

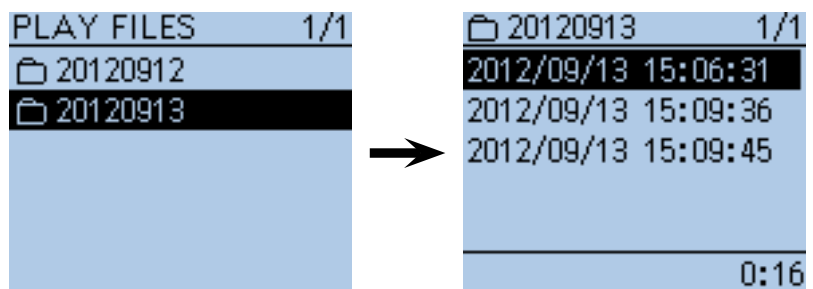
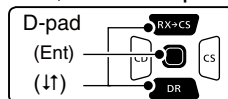

- ② Push D-pad(⬆) to select the file to play back, and then push D-pad(Ent).

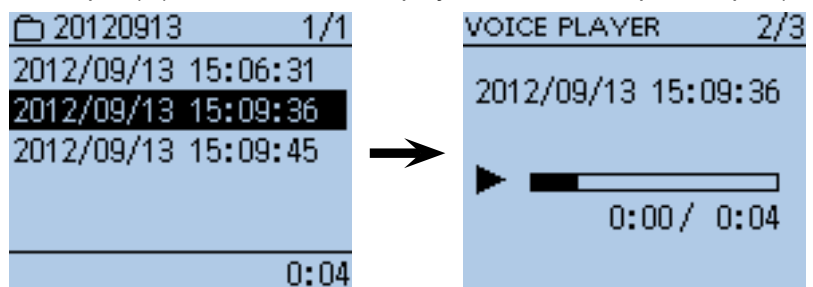

- The VOICE PLAYER screen is displayed and the selected file is played back.
- See “Operation while playing back” for forwarding or rewinding. (p. 11-6)
- ③ Push [MENU] or [CLR] to stop the playback.
- Return to the file list screen.

■ Voice Memo items (Continued)

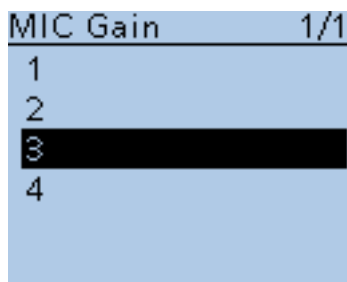

**MIC Gain**

**(Default: 3)**

Voice Memo > Voice Recorder > Recorder Set > MIC Gain (MIC Gain)

Set the internal microphone sensitivity to between 1 (minimum sensitivity) and 4 (maximum sensitivity), to suit your needs.

Higher values make the microphone more sensitive to your voice.

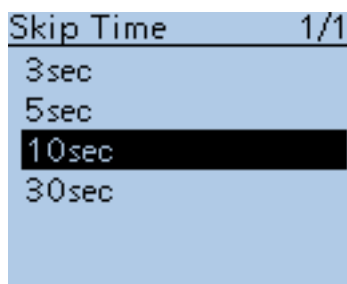

**Skip Time**

**(Default: 10sec)**

Voice Memo > Voice Recorder > Player Set > Skip Time (Skip Time)

Set the Skip Time to 3, 5, 10 or 30 seconds to rewind or skip forward for this set period when you push the fast-rewind or fast-forward key while playing the recorded voice audio.

- See "Operation while playing back" for forwarding or rewinding operation. (p. 11-6)

■ Voice Memo items (Continued)

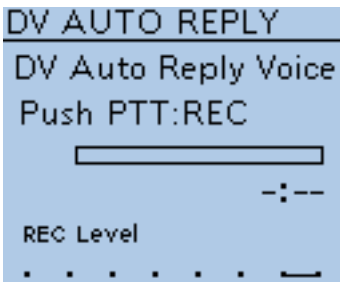

**DV Auto Reply**

Voice Memo > DV Auto Reply (DV AUTO REPLY)

Up to 10 seconds of audio can be recorded for the automatic reply function (p. 9-11).

⚡ Be sure to insert a microSD card into the transceiver before selecting this item.

- ① While pushing and holding [PTT], speak into the microphone at a normal voice level.
  - **DO NOT** hold the transceiver too close to your mouth or speak too loudly. This may distort your speech.

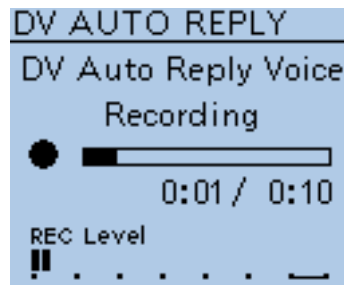

- ② The recording stops after 10 second or when [PTT] is released.

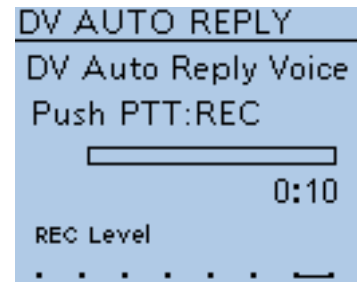
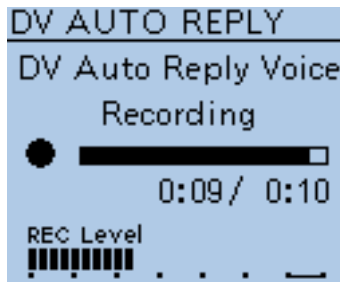

⚡ **NOTE:** The time display is different, as shown below.

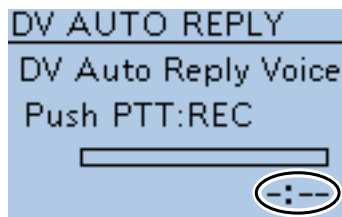

No audio was recorded (No audio file is saved.)

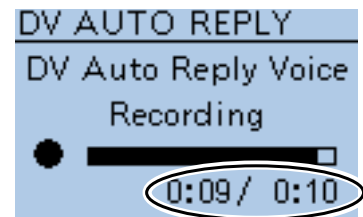

While recording (Recording time/Recordable time)

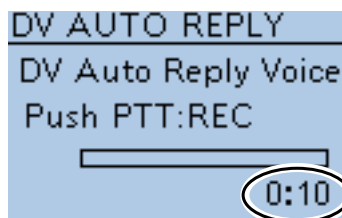

Recorded time (Recording stopped)

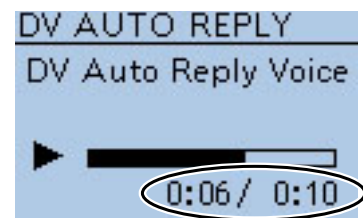

While playing back (Playback time/Recorded time)

## ■ Voice TX items

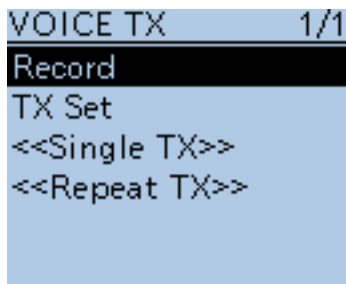

### Record

Voice TX > Record (VOICE TX RECORD)

Up to 1 minute of audio can be recorded onto a microSD card for voice transmission. (p. 17-3)

While recording a QSO voice audio, this function is disabled.

⚡ Be sure to insert a microSD card into the transceiver before selecting these items.

- ① While holding down [PTT], speak at a normal voice level.
  - **DO NOT** hold the transceiver too close to your mouth or speak too loudly. This may distort your speech.

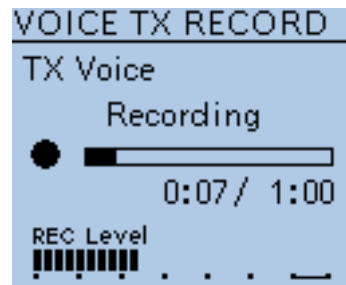

- ② The recording stops after 10 second or when [PTT] is released.

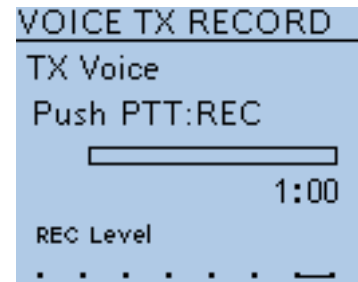
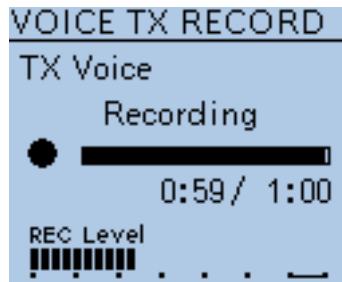

⚡ **NOTE:** The time display is different, as shown below.

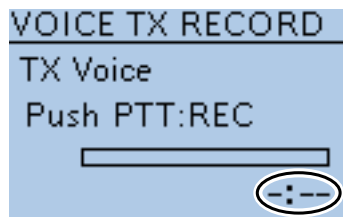

No audio was recorded (No audio file is saved.)

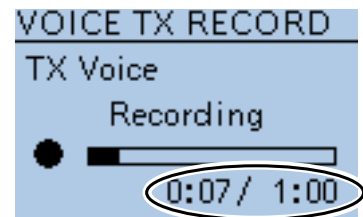

While recording (Recording time/Recordable time)

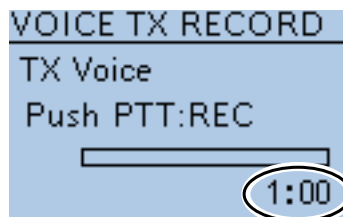

Recorded time (Recording stopped)

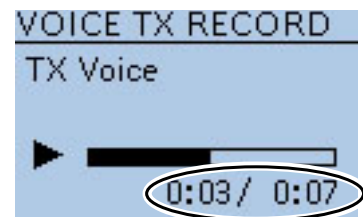

While playing back (Playback time/Recorded time)

■ Voice TX items (Continued)

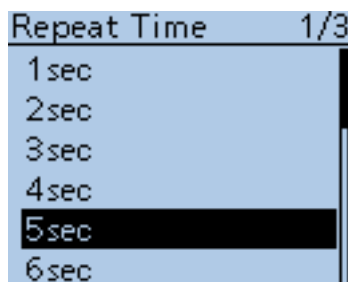

**Repeat Time** (Default: 5sec)

Voice TX > TX Set > Repeat Time (Repeat Time)

Set the repeat interval to between 1 and 15 seconds (in 1 second steps). The transceiver repeatedly transmits the recorded voice audio at this interval.

**NOTE:**  
 The recorded voice audio is repeatedly transmitted for up to 10 minutes. Even if 10 minutes passes while transmitting, the complete voice audio is transmitted.

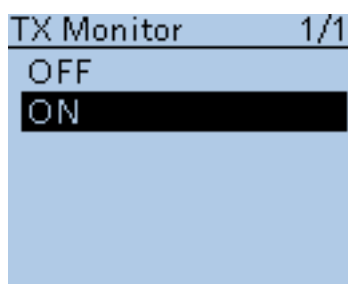

**TX Monitor** (Default: ON)

Voice TX > TX Set > TX Monitor (TX Monitor)

Turn the TX Monitor function ON or OFF.

- OFF : The TX voice audio is not heard from the speaker.
- ON : The TX voice audio is heard from the speaker.

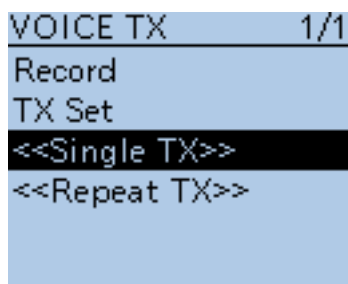

**<<Single TX>>**

Voice TX > TX Set > <<Single TX>>

The transceiver transmits the recorded voice audio once.  
 • To cancel the voice transmission, push [CLR]<sup>[V/MHz]</sup><sub>[CLR LOW]</sub>.

✓ **Convenient!**  
 You can transmit the recorded voice audio also from the QUICK MENU screen. (p. 17-3)

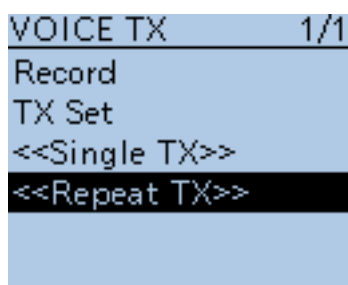

**<<Repeat TX>>**

Voice TX > TX Set > <<Repeat TX>>

The transceiver repeatedly transmits the recorded voice audio for up to 10 minutes at the specified interval in the Repeat Time item.  
 • To cancel the voice transmission, push [CLR]<sup>[V/MHz]</sup><sub>[CLR LOW]</sub>.

✓ **Convenient!**  
 You can transmit the recorded voice audio also from the QUICK MENU screen. (p. 17-3)

**NOTE:**  
 • The recorded voice audio is repeatedly transmitted for up to 10 minutes. Even if 10 minutes passes while transmitting, the complete voice audio is transmitted.  
 • One of the following steps will cancel the transmission.  
 - Push [PTT].  
 - Turn OFF the power, then turn it ON again.  
 - Push any key (except for [POWER]).  
 - Rotate [DIAL].

## ■ Broadcast (BC) Radio items

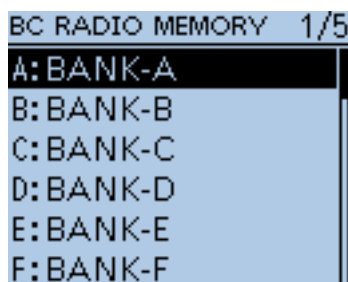

### BC Radio Memory

BC Radio > BC Radio Memory (BC RADIO MEMORY)

A total of 26 banks are selectable for BC Radio Memory. You can assign up to 50 BC Radio memory channels (combined FM and AM) to each bank, for easy memory management. (A maximum of 500 memories can be assigned to the BC Radio Memory.)

#### The display of the BC Radio memory

A to Z : Bank Name	Shows the banks in the BC Radio memory.
➤ FM	BC Radio memories for FM.
➤ AM	BC Radio memories for AM.

In the BC radio bank list, push [QUICK]<sup>QUICK</sup>[SPCH] to edit the selected bank name. (p. 6-9)

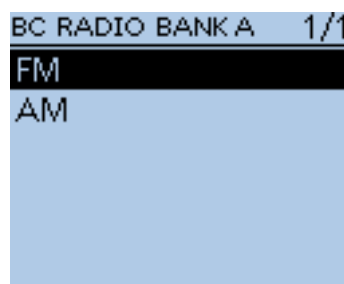

#### BC Radio memory channels

NAME	The name of a BC Radio memory channel Enter a name of up to 16 alphanumeric characters for each BC Radio memory channel.
BANK	The bank letter and the name of the bank
FREQUENCY	Programmed frequency For FM: Between 76.0* and 108.0 MHz For AM: Between 520 and 1710 kHz *The programmable frequency range differs, according to the transceiver's version.
SKIP	Shows the skip status. The Skip channel does not appear in the BC Radio memory.

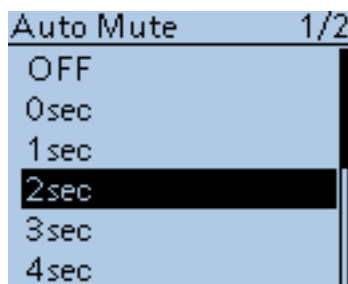

### Auto Mute

(Default: 2sec)

BC Radio > BC Radio Set > Auto Mute (Auto Mute)

Set the Auto Mute timer to between 0 and 10 seconds (in 1 second steps), or OFF.

- OFF : Even if the transceiver receives a signal on the A band or B band while listening to the BC Radio, the BC Radio audio is not muted.  
When the transceiver transmits on the A band or B band while listening to the BC Radio, the BC Radio audio is muted.
- 0 to 10sec : When the transceiver transmits or receives on the A band or B band while listening to the BC Radio, the BC Radio audio is automatically muted. After transmitting or receiving, the Auto Mute timer starts. After the timer period ends, you can listen to the BC Radio.

■ BC Radio items (Continued)

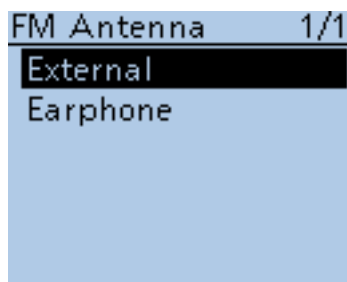

**FM Antenna** (Default: External)

BC Radio > BC Radio Set > FM Antenna (FM Antenna)

Select the desired antenna for FM radio.

- External : The connected antenna is used as the antenna.
- Earphone: The earphone cable antenna is used as the antenna.

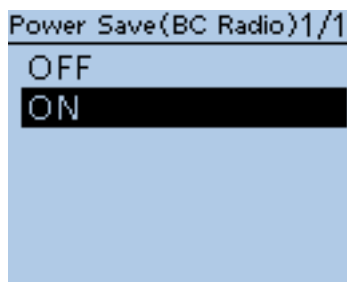

**Power Save (BC Radio)** (Default: ON)

BC Radio > BC Radio Set > Power Save (BC Radio) (Power Save (BC Radio))

Set the power save function to reduce current drain and conserve battery power when no radio signal is received.

- OFF : The power save function is OFF.
- ON : When the BC Radio is ON, and when no signal is received for 5 seconds, this function is activated in a 1:3 ratio (300 milliseconds: 900 milliseconds) during FM mode, or 1:1 ratio (2000 milliseconds: 2000 milliseconds) during AM mode.

⚡ **NOTE:** This function is disabled when the external power supply is used.

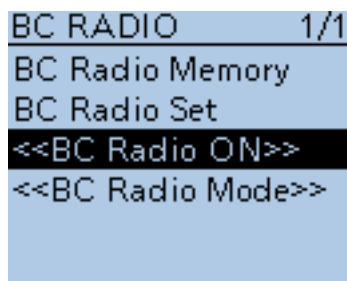

**<<BC Radio ON>>**

BC Radio > <<BC Radio ON>>

Turn ON the BC Radio.

When the transceiver receives 2 amateur bands on the MAIN band and SUB band, you can still listen to the Broadcast (BC) Radio.

When the BC Radio is ON, <<BC Radio OFF>> appears on the BC RADIO screen. To turn OFF the BC Radio, select <<BC Radio OFF>>.

- In the QUICK MENU screen, selecting <<BC Radio OFF>> also turns OFF the BC Radio.

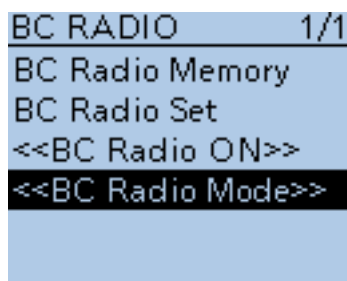

**<<BC Radio Mode>>**

BC Radio > <<BC Radio Mode>>

The transceiver switches into an exclusive BC Radio mode where only the BC Radio functions.

While in the BC Radio Mode, <<Normal Mode>> appears on the BC RADIO screen. To exit from the BC Radio mode, select <<Normal Mode>>.

- In the QUICK MENU screen, selecting <<Normal Mode>> also exits from the BC Radio mode.



## ■ GPS items

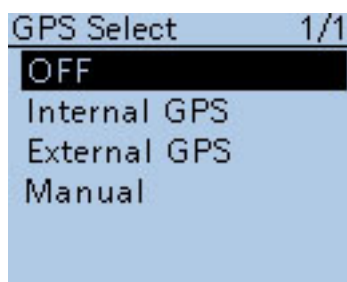

### GPS Select (Default: OFF)

GPS > GPS Set > GPS Select (GPS Select)

Select either an internal or external GPS receiver that the transceiver receives its position data from.

- OFF : A GPS receiver is not used.
- Internal GPS : Position data from the internal GPS data is used for the GPS functions.
- External GPS : Position data from the external GPS data is used for the GPS functions.
- Manual : Manually enter the current Latitude, Longitude and Altitude in Manual Position.

/// Slow-speed data communication is disabled when "External GPS" is selected. (p. 9-14)

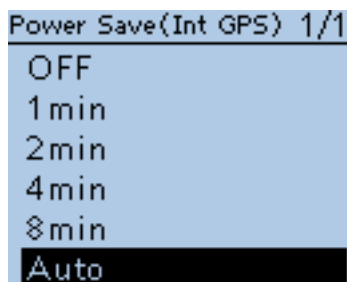

### Power Save (Internal GPS) (Default: Auto)

GPS > GPS Set > Power Save (Internal GPS)(Power Save (Int GPS))

Select whether or not to use the internal GPS receiver power save function. The power save function turns OFF power to the GPS receiver to conserve battery power.

When this function is ON, and if the GPS receiver does not receive signals from a satellite for 5 minutes, the power save function will turn OFF the GPS receiver for this set period of time.

- OFF : The receiver is continuously ON.
- 1, 2, 4, 8 min : When the receiver cannot receive signals from a satellite for 5 minutes, the GPS receiver power is turned OFF for the selected periods (1, 2, 4 or 8 minutes). After this period, the receiver resumes receiving.
- Auto : When the receiver cannot receive signals from a satellite for 5 minutes, the GPS receiver power is turned OFF for 1 minute. After this period, the receiver resumes receiving. The power save interval time extends to 2, 4 and then 8 minutes when receiving no signals for another 5 minutes, respectively. Once the GPS receiver receives initial position data, the power save interval is set back to 1 minute, if it receives no signals for 5 minutes.

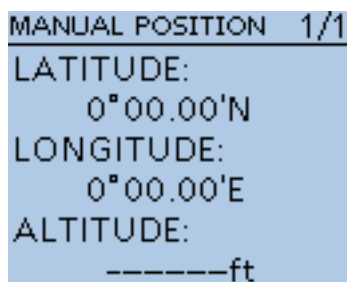

### Manual Position (Default: LATITUDE : 0°00'00"N LONGITUDE : 0°00'00"E ALTITUDE : -----ft)

GPS > GPS Set > Manual Position (MANUAL POSITION)

Manually enter the latitude, longitude and Altitude of your current position.

/// The received position data can be captured by selecting "Capture From GPS" when position data is received from either the internal or an external GPS. (p. 10-2)

■ GPS items (Continued)

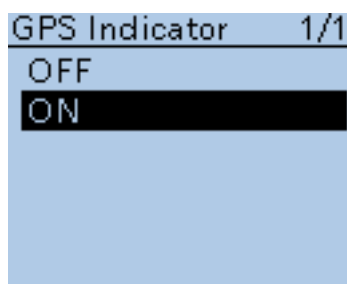

**GPS Indicator** (Default: ON)

GPS > GPS Set > GPS Indicator (GPS Indicator)

Select whether or not to display the GPS icon (GPS icon).

- OFF : The GPS icon is not displayed.
- ON : The GPS icon appears\* when valid position data is received, and blinks when no position data is received.

Selected GPS receiver	Not connected	Connected/ Searching	Connected/ Received
Internal GPS	–	Blinks	Appears
External GPS	Not displayed	Blinks	Appears

\*No icon appears when "Manual" is selected in the GPS select item.

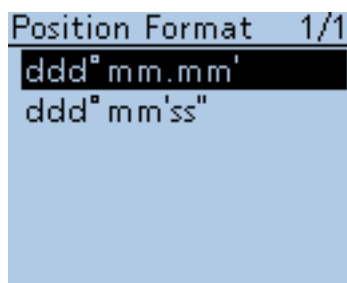

**Position Format** (Default: ddd°mm.mm')

GPS > GPS Set > Position Format (Position Format)

Select either the ddd°mm.mm' or ddd°mm'ss" format to display position information.

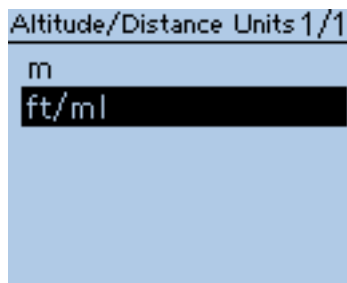

**Altitude/Distance Units** (Default: ft/ml\*)

GPS > GPS Set > Altitude/Distance Units (Altitude/Distance Units)

Select either the meter or feet/mile format to display the distance and altitude.

\*The default setting may differ, depending on the transceiver's version.

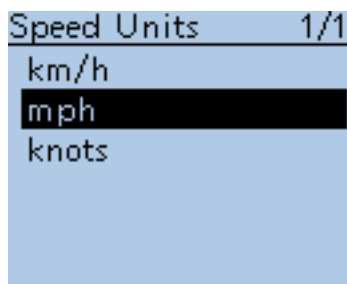

**Speed Units** (Default: mph\*)

GPS > GPS Set > Speed Units (Speed Units)

Select either the km/h, mph or knots format to display the speed.

\*The default setting may differ, depending on the transceiver's version.

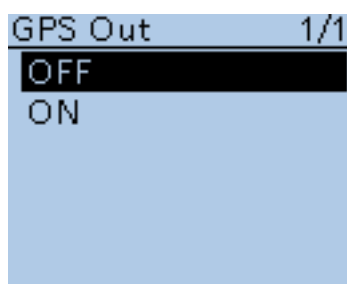

**GPS Out** (Default: OFF)

GPS > GPS Set > GPS Out (GPS Out)

Select whether or not GPS information from either the internal or external GPS receiver is output at the [DATA] jack.

✓ **For your information**

No data is output when "OFF" or "Manual" is selected in the GPS Select item.

Select "OFF" when you want to operate slow-speed data communication.

■ GPS items (Continued)



**GPS Information**

GPS > GPS Information (GPS INFO)

Displays the GPS satellite direction, altitude, satellite number and receiving status.

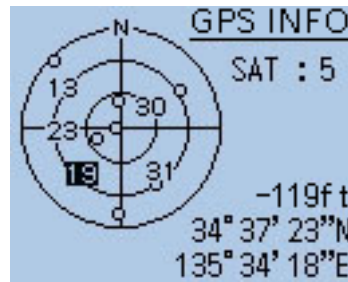

Example: tracking 5 satellites

○	Non tracking satellites
Regular characters (Example: 01)	Tracking satellites (weak signal)
Reversed characters (Example: 01)	Tracking satellites (strong signal)
SAT	Number of tracking satellite (between 0 and 12)
Altitude	-----ft (Non-positioning / 2D (Tracking three satellite) / Positioning results (4 or more satellite tracking))
Latitude	--°--.'-'-(Non-positioning)/Positioning results
Longitude	---°--.'-'-(Non-positioning)/Positioning results

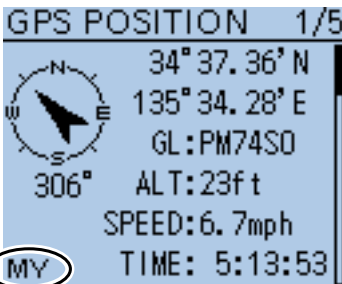

[MY] screen

**GPS Position**

GPS > GPS Position (GPS POSITION)

Your current position, received position or GPS memory alarm position information is displayed. (p. 10-3)

Push D-pad(↑) to select the screen to see the "MY," "RX," "MEM" and "ALM" screens.

/// **NOTE:** The default settings shown on the next page are for the USA version.  
 /// The default settings may differ, depending on your transceiver version.

■ GPS items (Continued)

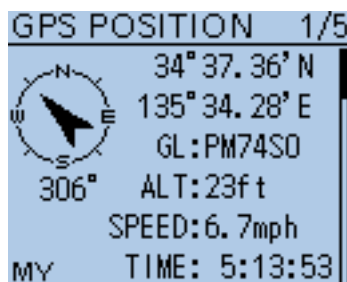

GPS Position (Continued)

**[MY] screen** (MY Position)

Compass*	Your direction
Latitude	Your latitude
Longitude	Your longitude
GL	Shows the grid locator based on the latitude and longitude of your position.
ALT	Your own altitude
SPEED	Your speed over ground
TIME	Current time received from the GPS
COURSE	Your direction heading

When "Manual" is selected in the GPS Select item, the screen shows only latitude, longitude, altitude, GL (Grid locator), and time (internal clock).

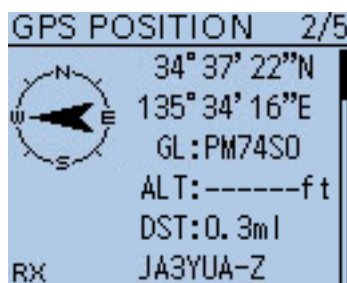

**[RX] screen** (Received position of the other station)

Compass*	The caller's direction from your position
Latitude	The caller's latitude
Longitude	The caller's longitude
GL	Shows the grid locator based on the latitude and longitude of the caller's position.
ALT	The caller's altitude
DST	The caller's distance from your position
Call sign	The caller's call sign
SSID	The caller's SSID (GPS-A only)
COURSE	The caller's direction over ground
SPEED	The caller's speed
GPS Time Stamp	The time data that the caller acquires the position data.
GPS-A Symbol	The caller's GPS-A Symbol

Nothing is displayed when No position data is received on your transceiver.

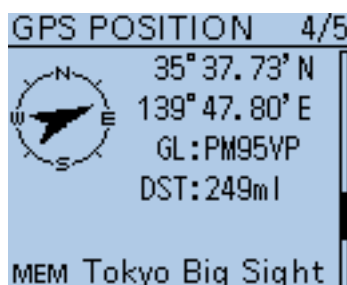
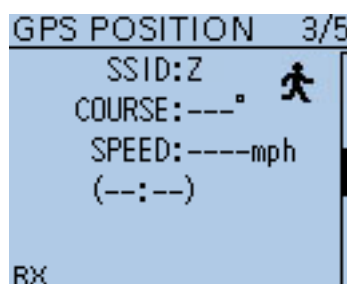

**[MEM] screen** (GPS memory alarm position)

Compass*	GPS Memory channel's direction from your position
Latitude	GPS Memory channel's latitude
Longitude	GPS Memory channel's longitude
GL	Shows the grid locator based on the latitude and longitude of GPS Memory channel's.
DST	GPS Memory channel's distance from your position
GPS memory name*	Shows the selected GPS memory name

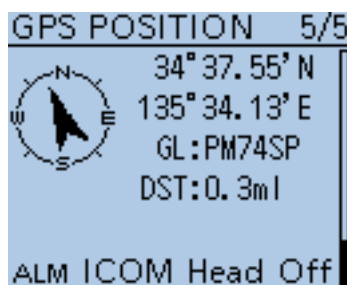

**[ALM] screen** (GPS alarm position)

Compass*	GPS Alarm area's direction from your position
Latitude	GPS Alarm area's latitude
Longitude	GPS Alarm area's longitude
GL	Shows the grid locator based on the latitude and longitude of GPS Alarm area's.
DST	GPS Alarm area's distance from your position
GPS Alarm*	Shows "OFF," "RX," GPS memory group name or GPS memory name specified for the GPS alarm function.

\*These items can be selected in the QUICK MENU screen.

■ GPS items (Continued)

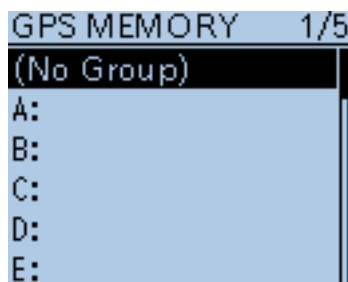

**GPS Memory**

GPS > GPS Memory (GPS MEMORY)

The transceiver has 200 GPS memory channels to store the received position data, or often-used position data, along with an alphanumeric channel name.

The channels can be divided into the "(No Group)" group and each memory group for easy memory management.

**The display of the GPS memory**

(No Group)	GPS memories not assigned to any group.
A to Z : Group Name	GPS memories assigned to the selected group.

**GPS memory groups (A-Z)**

GROUP NAME	The name of a GPS memory group Enter a name of up to 16 alphanumeric characters for each GPS group.
------------	--

The GPS memory group name can be edited in the QUICK MENU screen. (p. 10-11)

**GPS memory channels**

NAME	The name of a GPS memory channel Enter a name of up to 16 alphanumeric characters for each GPS memory channel.
DATE	Stored date
TIME	Stored time
LATITUDE	Stored location (latitude)
LONGITUDE	Stored location (longitude)
GROUP	The group letter and the name of the group

- /// When the received position data is stored using the "GPS Positon" screen, the received station's call sign is used as using the GPS memory name.
- /// GPS memory contents, such as GPS memory name, can be edited in the QUICK MENU screen. (pp. 10-7 to 10-10)

■ GPS items (Continued)

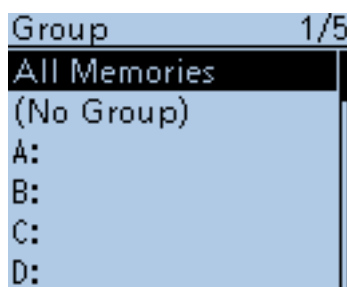
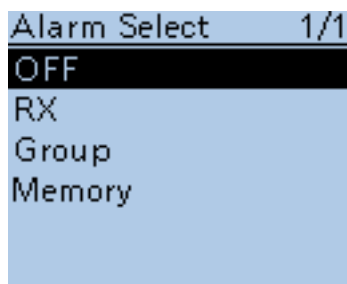

When "Group" is selected

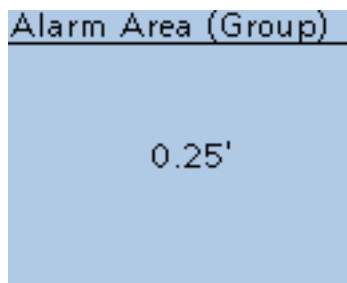

**Alarm Select**

**(Default: OFF)**

GPS > GPS Alarm> Alarm Select (Alarm Select)

Select the target position(s) for the GPS alarm function.

- OFF : Turns the function OFF.
- RX : The last position data received from a station is stored in a temporary memory, and is used for the GPS alarm function. When the target enters in the active alarm range, the GPS alarm sounds. The active alarm range is specified in Alarm Area (RX/Memory). (p. 16-38)
- Group : All memories in the GPS memory, or in the selected GPS memory group, are used for the GPS alarm function. When the target enters in the active alarm range, the GPS alarm sounds. The active alarm range is specified in Alarm Area (Group).
- Memory : Only one memory in the GPS memory is used for the GPS alarm function. When the target enters in the active alarm range, the GPS alarm sounds. The active alarm range is specified in Alarm Area (RX/Memory). (p. 16-38)

**Alarm Area (Group)**

**(Default: 0.25')**

GPS > GPS Alarm> Alarm Area (Group) (Alarm Area (Group))

When the Alarm Select is set to "Group" or one of the memory groups, set the GPS alarm active range.

When a target enters in the specified active alarm range, the GPS alarm sounds and the GPS alarm icon blinks.

The programmable values depend on the setting in Position Format.

- Position Format = dddmm.mm' 00.08' to 59.99' (0.01' steps)
- Position Format = dddmm'ss" 00'05" to 59'59" (0'01" steps)

**Example:**

When a target enters in the active alarm range, the GPS alarm sounds.

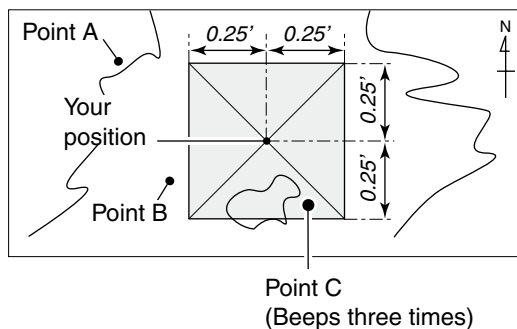

■ GPS items (Continued)

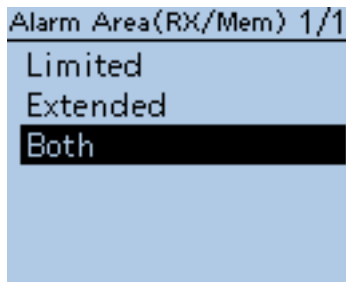

**Alarm Area (RX/Memory)**

**(Default: Both)**

GPS > GPS Alarm> Alarm Area (RX/Memory) (Alarm Area (RX/Mem))

Select the GPS active alarm range.

When the Alarm Select is set to “RX” or “Memory,” set the GPS alarm active range to “Both,” “Extended” or “Limited”.

When a target position enters in the active alarm range, the GPS alarm sounds and the GPS alarm icon blinks.

- Limited : The transceiver sounds 3 beeps and the GPS alarm icon blinks when the target enters the 500 meter range.
- Extended : The transceiver sounds 3 beeps and the GPS alarm icon blinks when the target enters the 1 kilometer range.
- Both : The transceiver sounds a beep and the GPS alarm icon blinks when the target enters the 1 kilometer range, and sounds 3 beeps and the icon blinks when it enters the 500 meter range. When the target exits the 500 meter range, but is still in the 1 kilometer range, the icon continues to blink, but no beeps sound.

**Example:**

When a target enters in the active alarm range (500 meter or 1 kilometer range, depending on the setting), the GPS alarm sounds.

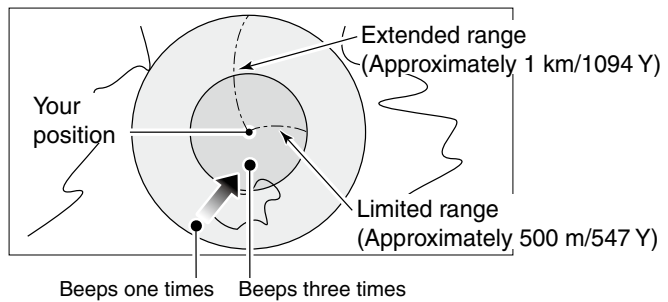

■ GPS items (Continued)

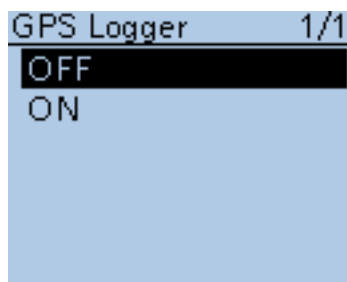

**GPS Logger**

**(Default: OFF)**

GPS > GPS Logger > GPS Logger (GPS Logger)

Turn the GPS Logger function ON or OFF.

This function logs the position, altitude, course, speed and number of satellites being used.

- OFF : Turns the function OFF.
- ON : The transceiver automatically logs GPS data. Once this function is turned ON, the GPS data will be continuously logged until turning it OFF, even if the transceiver power is turned OFF, then ON again.

**To use this function:**

1. You must first insert a microSD card into the transceiver.
2. You must select either Internal GPS or External GPS in GPS select.

**NOTE:**

The log data will be saved on the microSD card.

The file name is automatically created, as shown in the example below:

Log start date and time: 2012/9/1 15:30:00

File name: 20120901\_153000.log

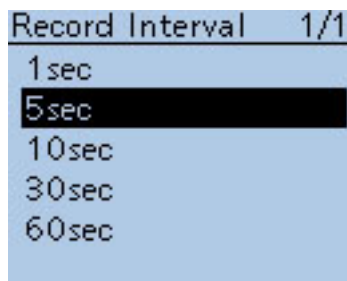

**Record Interval**

**(Default: 5sec)**

GPS > GPS Logger > Record Interval (Record Interval)

Select the GPS Logger function record interval of 1, 5, 10, 30 or 60 seconds.



■ GPS items (Continued)

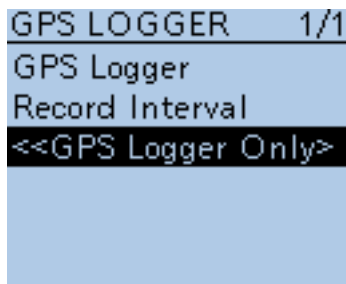

<<GPS Logger Only>>

GPS > GPS Logger > <<GPS Logger Only>>

The transceiver switches into an exclusive GPS logger mode where only the logger is functioning.

- Select “Internal GPS” or “External GPS” in GPS Select screen and insert a microSD card.
- During the exclusive GPS logger mode, the transceiver’s transmission and reception are disabled.
- To cancel the exclusive GPS logger mode, reboot the transceiver.

① Push D-pad(Ent).

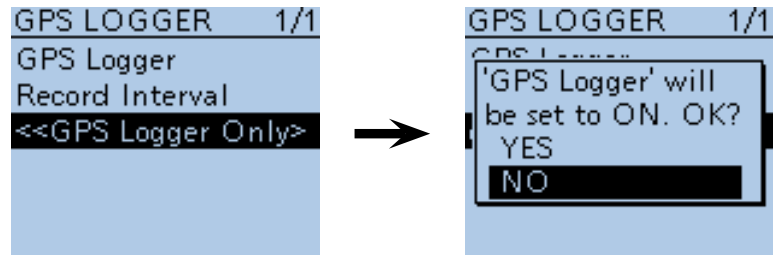
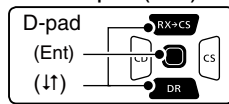

② Push D-pad(↑) to select “YES;” and then push D-pad(Ent).

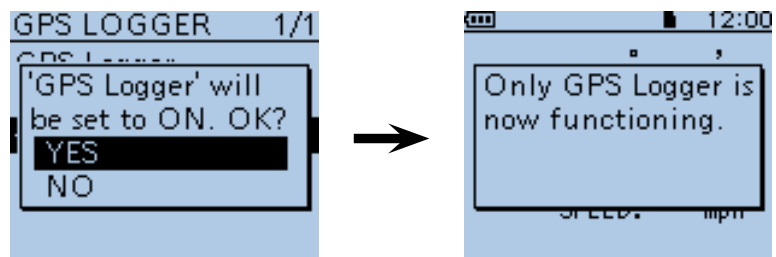

- When the GPS logger function is set to “ON,” the GPS logger mode is started immediately after pushing D-pad(Ent).

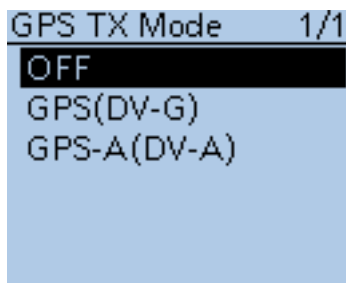

GPS TX Mode

(Default: OFF)

GPS > GPS TX Mode (GPS TX Mode)

Select a GPS transmission mode to send position data received from a GPS receiver while in the DV mode.

- OFF : Position data is not transmitted.
- GPS (DV-G) : Transmits position data in NMEA format. (the TX GPS mode is “GPS”)
- GPS-A (DV-A) : Transmits position data in the format corresponding to D-PRS. (the TX GPS mode is “GPS-A”) In the GPS-A mode, the normal GPS-A codes are transmitted to the PC connected to the transceiver. GPS-A code is based on **APRS**® code. (APRS® : Automatic Packet Reporting System)

- When “GPS” or “GPS-A” is selected, the slow-speed data communication is disabled. (p. 9-14)

■ GPS items (Continued)

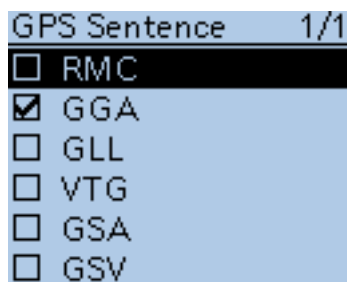

**GPS Sentence**

(Default: GGA)

GPS > GPS TX Mode > GPS(DV-G) > GPS Sentence (GPS Sentence)  
 Select sentences to be transmitted in the GPS mode to transmit position data.

- Select up to 4 of the 6 GPS sentences to transmit at the same time. RMC, GGA, GLL, VTG, GSA and GSV sentences are selectable. Even if the GPS Auto TX Timer is set to "5 sec.," when 4 sentences are selected in this setting, the time the GPS Auto TX Timer will automatically be changed to "10 sec."
- "VTG," "GSA" and "GSV" sentences will not be transmitted when your position has been set manually. This GPS Sentence item will be hidden when "GPS-A(DV-A)" or "OFF" is selected in "GPS TX Mode."

• **Contents of GPS sentence**

The Time Stamp is shown based on the **UTC** (Universal Time Coordinated) time.

Sentence	Lat/Lon	Alt	GPS Time Stamp (UTC)	Date (UTC)	Status	2D/3D	COG (True)	SOG (knot)
RMC	✓		✓	✓	✓			
GGA	✓	✓	✓		✓			
GLL	✓		✓		✓			
VTG							✓	✓
GSA					✓	✓		
GSV								

Sentence	Others
RMC	Mode Indicator
GGA	Number of satellites in use, HDOP, Geoidal separation, Age of Differential GPS data
GLL	Mode Indicator
VTG	COG (Magnetic north), SOG (km/h), Mode Indicator
GSA	ID numbers of satellites used in solution, PDOP, HDOP, VDOP
GSV	Total number of sentences, Sentence number, Total number of satellites in view, Satellite information (ID, Altitude, Azimuth, S/N)

**NOTE:**

Set the GSV sentence to OFF when sending the GPS message to conventional digital transceivers (IC-2820H, IC-E2820, ID-800H, IC-91AD, IC-E91, IC-V82, IC-U82, IC-2200H, ID-1).

The GSV sentence is incompatible with them. Those transceivers will not display GPS messages properly if sent as a GSV sentence from the ID-51A/E.

■ GPS items (Continued)

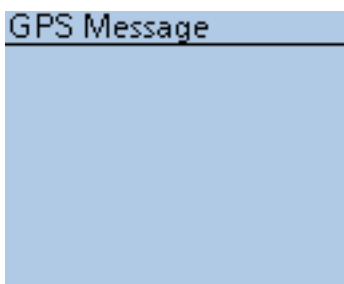

**GPS Message**

GPS > GPS TX Mode > GPS(DV-G) > GPS Message (GPS Message)

Enter a GPS message of up to 20 alphanumeric characters. (p. 10-17)

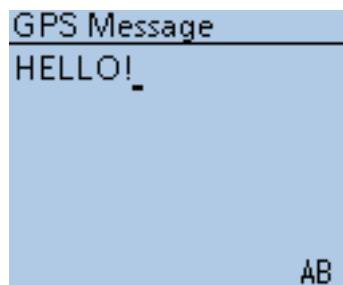

GPS Message edit screen

This GPS Message item will be hidden when "GPS-A(DV-A)" or "OFF" is selected in "GPS TX Mode."

/// **NOTE:** When no message transmission is desired, delete the programmed message in the QUICK MENU screen.

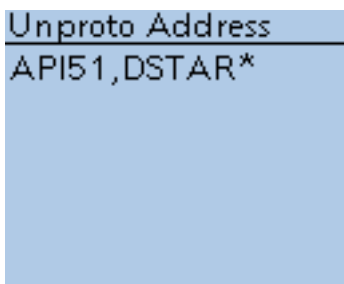

**Unproto Address**

(Default: API51,DSTAR\*)

GPS > GPS TX Mode > GPS-A(DV-A) > Unproto Address (Unproto Address)

Enter an unproto address of up to 56 alphanumeric characters.

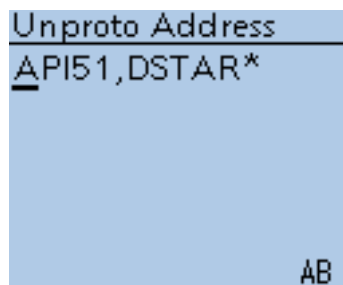

Unproto address edit screen

This Unproto Address item will be hidden when "GPS(DV-G)" or "OFF" is selected in "GPS TX Mode."

■ GPS items (Continued)

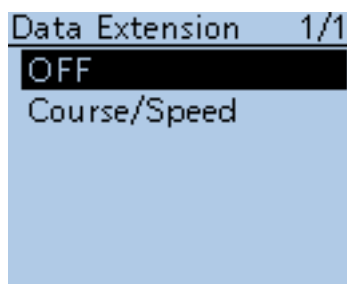

**Data Extension** (Default: OFF)

GPS > GPS TX Mode > GPS-A(DV-A) > Data Extension (Data Extension)

Select whether or not to transmit the course and speed data in addition to the position data.

- OFF : Transmits only the position data.
- Course/Speed: Transmits the course and speed data in addition to the position data.

The course and speed data will not be transmitted even if “Course/Speed” is selected, when your position is set manually.

This Data Extension item will be hidden when “GPS(DV-G)” or “OFF” is selected in “GPS TX Mode.”

**NOTE:**  
 When “Course/Speed” is selected, the number of Comment characters is limited to 36.  
 When “Course/Speed” is selected, and Altitude option is set to “ON,” the number of Comment characters is limited to 28.

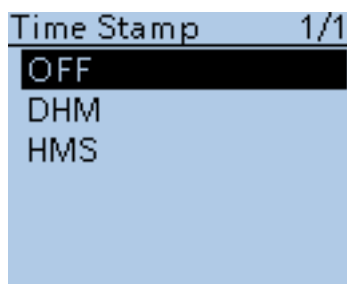

**Time Stamp** (Default: OFF)

GPS > GPS TX Mode > GPS-A(DV-A) > Time Stamp (Time Stamp)

Sets the transmitting time stamp type to DHM, HMS or OFF. The time stamp is transmitted with the position data in the GPS-A mode, and UTC (Universal Time Coordinated) time is used.

- OFF : No time stamp is transmitted.
- DHM : Transmits the time stamp in the Day, Hour, and Minute format.
- HMS : Transmits the time stamp in the Hour, Minute, and Second format.

When your position is set manually, the time stamp data will not be transmitted, even if “DHM” or “HMS” is selected.

This Time Stamp item will be hidden when “GPS(DV-G)” or “OFF” is selected in “GPS TX Mode.”

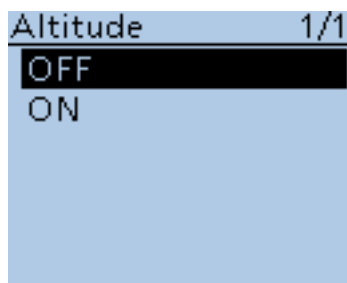

**Altitude** (Default: OFF)

GPS > GPS TX Mode > GPS-A(DV-A) > Altitude (Altitude)

Select whether or not to transmit altitude data, in addition to position data.

- OFF : No altitude data is transmitted.
- ON : Transmits altitude data in addition to position data.

This Altitude item will be hidden when “GPS(DV-G)” or “OFF” is selected in “GPS TX Mode.”

**NOTE:**  
 When “ON” is selected, and Data Extension option is set to “OFF,” the number of Comment characters is limited to 35.  
 When “ON” is selected, and Data Extension option is set to “Course/Speed,” the number of Comment characters is limited to 28.

■ GPS items (Continued)

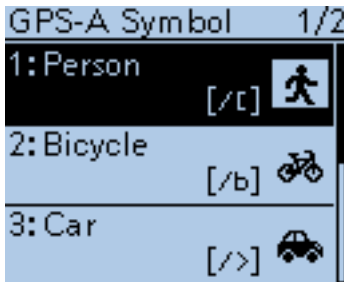

**GPS-A Symbol**

(Default: Person)

GPS > GPS TX Mode > GPS-A(DV-A) > GPS-A Symbol (GPS-A Symbol)

The GPS-A symbol is an icon which represents your means of transportation or location. The stored GPS-A symbol in the selected GPS-A channel (1 to 4) is transmitted with position data while in the GPS-A mode.

To change the GPS-A symbol channel, push D-pad(↑) to select, and then push D-pad(Ent) to set.

This GPS-A Symbol item will be hidden when “GPS(DV-G)” or “OFF” is selected in “GPS TX Mode.”

**GPS-A Symbol channel**

A GPS-A symbol can be set to GPS symbol channels 1 to 4.

You can select a desired GPS-A symbol different than the preprogrammed one or other symbol by entering a 2 character GPS-A code.

**Selecting a GPS-A symbol with a 2 character symbol code**

- ① Push D-pad(↑) to select a desired GPS-A Symbol channel between 1 and 4.

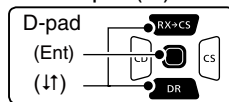

- ② Push [QUICK] [QUICK] to select “Edit Symbol,” and then push D-pad(Ent).
- ③ Push [QUICK] [QUICK] again.
- ④ Push D-pad(↑) to select “Direct Input,” and then push D-pad(Ent).
- ⑤ Rotate [DIAL] to select the first digit.
  - Usable characters: /, \, 0 to 9, A to Z
- ⑥ Push [CS] to select the second digit.

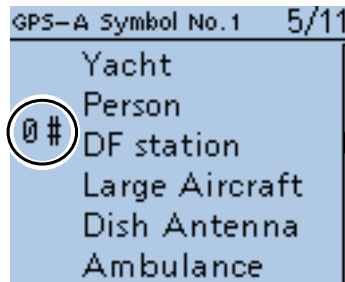

Second digit is selected

- ⑦ Rotate [DIAL] to select the second digit, and then push D-pad(Ent).
  - Usable characters: Alphanumeric characters and symbols
- ⑧ Push D-pad(Ent) to set the GPS-A Symbol into the channel selected in step ①.
  - Returns to the GPS-A SYMBOL screen.

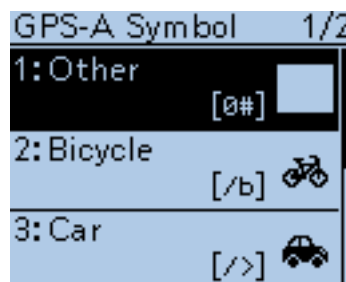

- ⑨ Pushing D-pad(Ent) again to set the GPS-A symbol channel, selected in step ①, which is used for GPS-A operation.

■ GPS items (Continued)

**Selecting a preprogrammed GPS-A symbol**

① Push D-pad(↑) to select a desired GPS-A Symbol channel between 1 and 4.

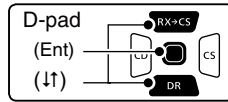

② Push **QUICK SPCH** to select “Edit Symbol,” and then push D-pad(Ent).

③ Push D-pad(↑) to select a desired GPS-A Symbol.

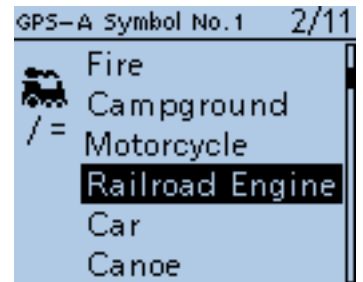

④ Push D-pad(Ent) to set the GPS-A Symbol into the channel selected in step ①.

- Returns to the GPS-A SYMBOL screen.

⑤ Pushing D-pad(Ent) again to set the GPS-A symbol channel, selected in step ①, which is used for GPS-A operation.

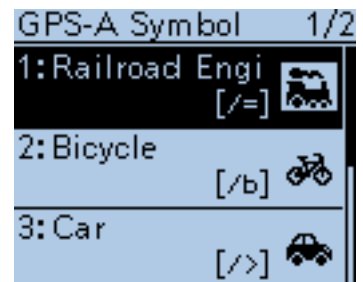

Selecting “1: Railroad Engine”

**GPS-A Symbol list**

	Sheriff		Police		Glider		Satellite
	Small Aircraft		Recreational Vehicle		Hospital		Sunny
	Red Cross		Shuttle		Jeep		Radio
	House QTH (VHF)		SSTV		Truck		Aircraft
	X		Bus		Node		RACES
	Red Dot		ATV		Rover		Gale Flags
	Fire		WX Service		Ship(powerboat)		Ham Store
	Campground		Helicopter		Truck(18-wheeler)		Work Zone
	Motorcycle		Yacht		Van		Speedpost(Value Signpost)
	Railroad Engine		Person		Yagi @ QTH		Triangle
	Car		DF station		House (HF)		Small Circle
	Canoe		Large Aircraft		Big Question Mark		Overlaid Ship
	Eyeball		Dish Antenna		Circle		Tornado
	School		Ambulance		Park/Picnic Area		Overlaid Truck
	PC User		Bicycle		Overlaid Car		Overlaid Van
	Balloon		Fire Truck		Lighthouse		Wreck

## ■ GPS items (Continued)

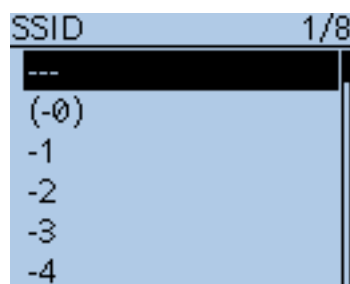
**SSID****(Default: ---)**

GPS &gt; GPS TX Mode &gt; GPS-A(DV-A) &gt; SSID (SSID)

Select an SSID based on **APRS®** to add to your call sign, to show your operating style to other stations.

The addition methods of the SSID may differ, depending on whether the call sign includes a space or not.

- --- : The space in the call sign is converted to “-.”  
Text after the space will be used as the SSID.  
But if no text is programmed after the space, the space will be deleted, and no SSID is added.  
Example: “JA3YUA” ➔ “JA3YUA”  
(no SSID is added)  
“JA3YUA A” ➔ “JA3YUA-A”  
 (“A” is changed to “-A”, and it is used as the SSID)
- (-0) : No SSID is added.  
If a call sign includes a space, any text or digit after the space will be deleted.  
Example: “JA3YUA” ➔ “JA3YUA”  
(no SSID is added)  
“JA3YUA A” ➔ “JA3YUA”  
(no SSID is added)
- -1 to -15: Adds an SSID of -1 to -15 to the call sign.  
Even if a call sign includes a space and text, it will be automatically changed to this set numeric ID.  
Example(SSID [-9]):  
“JA3YUA” ➔ “JA3YUA-9”  
 (“-9” is added, and used as the SSID)  
“JA3YUA A” ➔ “JA3YUA-9”  
 (“A” is changed to “-9”, and it is used as the SSID)
- -A to -Z : Adds an SSID of -A to -Z to your call sign.  
Even if a call sign includes a space and a text, it will be automatically changed to this set letter ID.  
Example(SSID [-Z]):  
“JA3YUA” ➔ “JA3YUA-Z”  
 (“-Z” is added, and used as the SSID)  
“JA3YUA A” ➔ “JA3YUA-Z”  
 (“A” is changed to “-Z”, and it is used as the SSID)

This SSID item will be hidden when “GPS(DV-G)” or “OFF” is selected in “GPS TX Mode.”

**About SSID**

To assist in identifying a station's type, designated call sign SSIDs are used in D-PRS (APRS®), according to the common guideline.

The guideline may be changed when the infrastructure environment, such as a product or network, is changed.

Please check the latest guideline in the web site related on the D-PRS or APRS®, and correctly set.

■ GPS items (Continued)



**Comment**

GPS > GPS TX Mode > GPS-A(DV-A) > Comment (Comment)

Enter a comment of up to 43 characters to transmit with the position data.

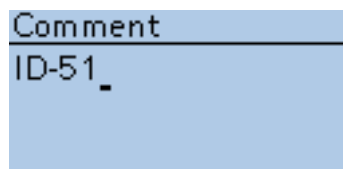

Comment edit screen  
(In case of up to 43 characters)

The number of characters to enter will differ, depending on the Data Extension and Altitude settings. (p. 16-43)

Data Extension	Altitude	The number of characters
OFF	OFF	Up to 43 characters (Default)
OFF	ON	Up to 35 characters
Course/Speed	OFF	Up to 36 characters
Course/Speed	ON	Up to 28 characters

The symbol “**J**” shows the transmittable comment range. Please note that the characters that exceed the range from the symbol will not be transmitted.

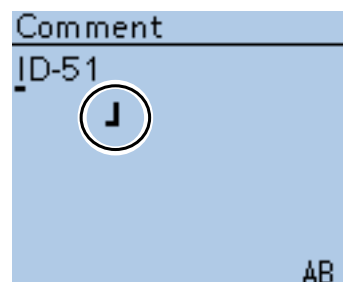

Transmittable comment range display  
(In case of up to 36 characters)

This comment item will be hidden when “GPS(DV-G)” or “OFF” is selected in “GPS TX Mode.”

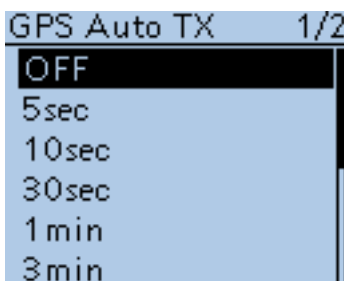

**GPS Auto TX**

(Default: OFF)

GPS > GPS Auto TX (GPS Auto TX)

Select an option for the GPS automatic transmission function. This function automatically transmits the current position data received from a GPS receiver, as well as any programmed GPS message, at the selected interval.

- OFF : Turns the function OFF. However, you can transmit the position data manually by pushing [PTT].
- 5 sec to 30 min : Transmits the current position data at the selected interval (5\*, 10, or 30 seconds, or 1, 3, 5, 10, or 30 minutes).  
\*When four GPS sentences are selected at the same time in GPS Sentence Mode, “5sec” cannot be selected.

/// **NOTE:** When “Manual” is selected in GPS Select, the current position data will not be automatically transmitted.



## ■ Call sign items

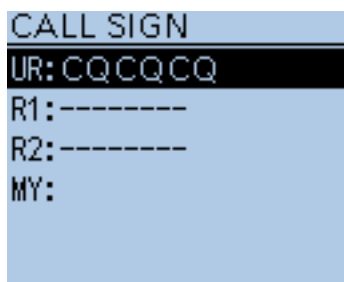

### Call Sign

Call Sign (CALL SIGN)

Sets or displays the “UR,” “R1,” “R2” and “MY” call signs to be used for DV operation.

Except for the DR mode, sets the desired call signs to be used for DV operation in this screen.

**For Simplex operation (DV mode)**

“UR” (p. 16-49) and “MY” call signs can be set.

**For Duplex (repeater) operation (DV/DR mode)**

While in the DR mode, the only “MY” call sign can be set.

**<To set Duplex (repeater) operation>**

**Example:** While in the DV mode, Making a Gateway call Making a gateway CQ call to Hamacho **repeater** (JP1YIU B) from the Hirano repeater (JP3YHH B)\*, while in the DV mode.

\*Before starting to set the call sign, set the frequency of your access repeater or duplex direction. (See pages 5-6 and 15-5.)

**NOTE:** When the Digital Repeater Setting function is ON, the repeater call sign can be automatically set. (p. 16-57)

**1. Call sign (“R1”) setting**

① While in the DV mode, push D-pad(⬇) to select “R1,” and then push [QUICK] <sup>QUICK</sup> <sub>SPCH</sub>.

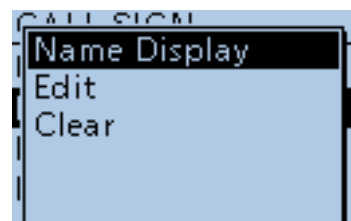
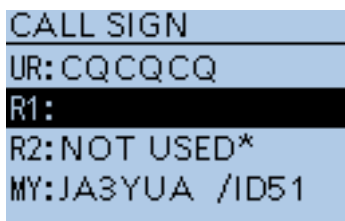
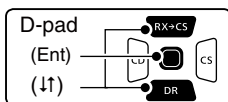

- ② Push D-pad(⬇) to select “Edit,” and then push D-pad(Ent).
- ③ Rotate [DIAL] to select the first character.
  - Alphanumeric characters and symbol (“/”) can be entered.
- ④ Push [⬅] to move the cursor backward, or push to [➡] move the cursor forward.
- ⑤ Repeat steps ③ and ④ to enter a name of up to 8 characters, including a spaces.
- ⑥ After entering, push D-pad(Ent) to set.

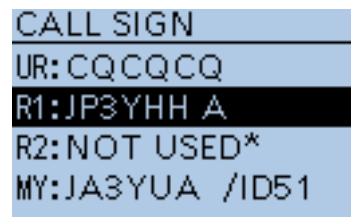
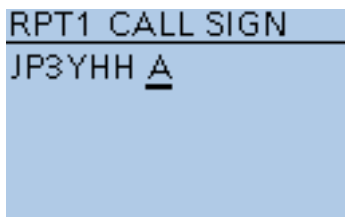

(Continued on the next page.)

■ Call sign items (Continued)

**2. Gateway (“R2”) setting**

① Push D-pad(↑) to select “R2,” and then push D-pad(Ent).



② Push D-pad(↑) to select “GW,” and then push D-pad(Ent).

- When you manually enter the call sign, push in step ①.

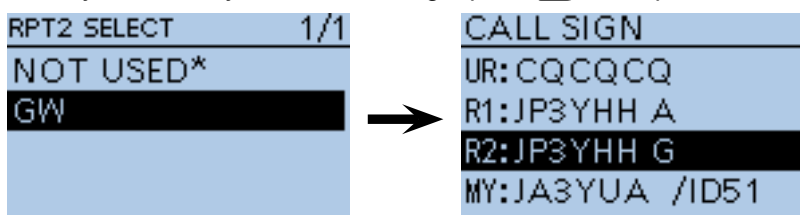

**About the RPT2 SELECT screen**

NOT USED*	For local area call
GW	To select the gateway call sign from the repeater list.
Repeater name	To select the <b>repeater</b> that has the same gateway as the “R1” repeater.

**3. Destination (“UR”) setting**

① Push D-pad(↑) to select “UR,” and then push D-pad(Ent).

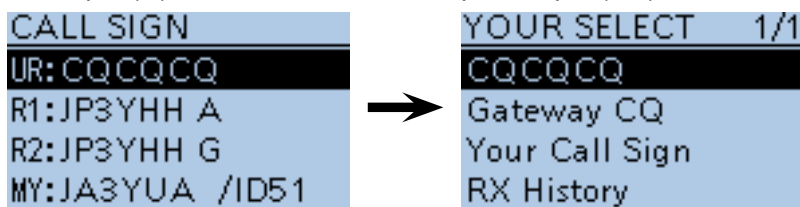

② Push D-pad(↑) to select “Gateway CQ,” and then push D-pad(Ent).

③ Push D-pad(↑) to select “11:Japan”(repeater group where your destination repeater is listed), and then push D-pad(Ent).

④ Push D-pad(↑) to select “Hamacho430,” and then push D-pad(Ent).

- When you manually enter the call sign, push in step ①.

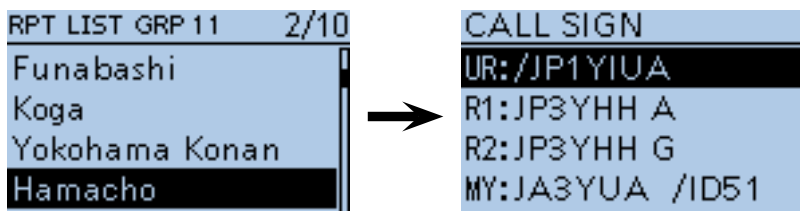

**About the YOUR SELECT screen**

CQCQCQ	To select “CQCQCQ” to make a non-call sign specific call.
Gateway CQ†	To select “Gateway CQ” using the repeater list.
Your Call Sign	To select the destination (“UR”) call sign using the Your Call Sign memory.
RX History	To select the destination (“UR”) call sign using the RX History.
TX History	To select the destination (“UR”) call sign using the TX History.

†Not displayed in the **Simplex** mode.

## RX History items

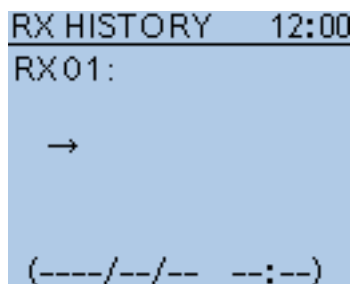

### RX History

RX History (RX HISTORY)

When a call is received in the DV mode, the call information such as the caller station call sign, used **repeater** call sign, and so on, are stored in this screen.

Up to 50 records can be stored.

- Even if the transceiver power is turned OFF, the stored records are not deleted.

You can confirm the RX record contents with D-pad(Ent).

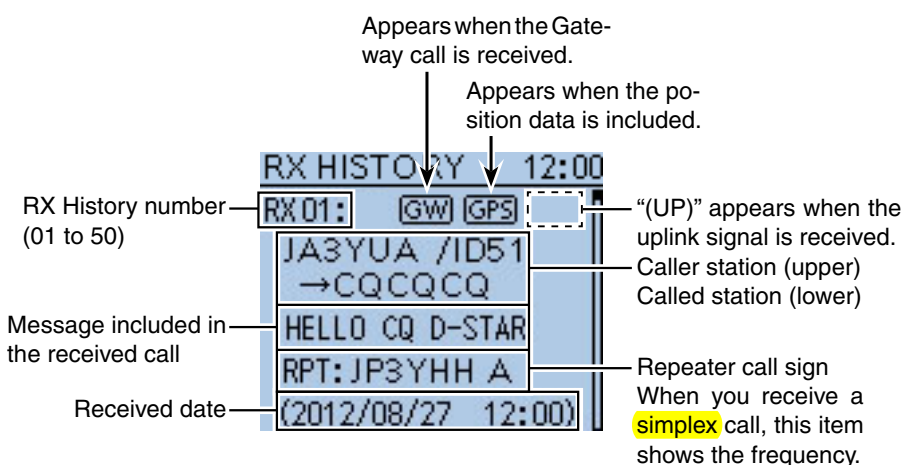

### Contents of the RX history Top screen

RX01–RX50	RX history number
CALLER*	Shows the call sign of the caller station and any note programmed after the call sign.
CALLED*	Shows the call sign of the called station.
MESSAGE	Shows any message included in the received call, if programmed.
RXRPT2*	Shows the call sign of the repeater you received the call from.
FREQUENCY	Shows the simplex frequency.
RX TIME	Shows the date and time the call was received.
GW	Appears when a Gateway call is received.
GPS	Appears when position data is included.
UP	Appears when an uplink signal is received.

\* These items can be switched to the Name display.

■ RX History items (Continued)

**To display the RX record contents**

- ① Push D-pad(↑) to select the desired RX History number “RX01” to “RX50,” and then push D-pad(Ent).

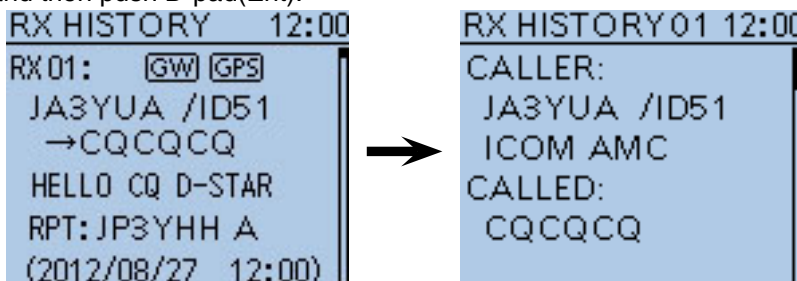

- ② Push D-pad(↑) to switch the RX History contents screen.
  - When the received call includes GPS position data, it is displayed after RX TIME.
  - To register the caller station call sign, GPS information, or **repeater** call sign, push D-pad(↑) to show the desired contents, and then push [QUICK] (QUICK SPCH).
- ③ Push [MENU] (MENU) to exit the MENU screen.

**Contents of the RX history**

CALLER*1	Shows the call sign of the caller station and any note programmed after the call sign.
CALLED*1	Shows the call sign of the called station.
RXRPT1*1, *2	Shows the call sign of the repeater that was accessed by the caller station. If it was a call through a gateway and the internet, this item displays the gateway repeater call sign of your local area repeater.
RXRPT2*1, *2	Shows the call sign of the repeater you received the call from.
MESSAGE	Shows any message included in the received call, if programmed.
RX TIME	Shows the date and time the call was received.
COMPASS*3	Shows the direction from your position to the caller station.
LATITUDE	Shows the Latitude position of the caller station.
LONGITUDE	Shows the Longitude position of the caller station.
GL(Grid Locator)	Shows the latitude and longitude position data in a short string of characters.
ALTITUDE	Shows the altitude of the caller station, The altitude unit can be set to either the meter or feet/mile format in the GPS menu.
DISTANCE*3	Shows the distance between you and the caller station.
GPS-A SYMBOL	Shows a GPS-A symbol of the caller station. (GPS TX mode: GPS-A)
SSID	Shows the <b>APRS</b> ® based SSID (Secondary Station Identifier: “-0,” “-1” to “-15,” “-A” to “-Z”) when the caller station’s GPS TX mode is set to “GPS-A” to assist identifying the caller station.
COURSE	Shows the course of the caller station.
SPEED	Shows the speed the caller station is moving at. The speed unit can be set to the km/h, mph or knots format in the GPS menu.
GPS Time Stamp	The time data that the caller acquires the position data.
GPS MESSAGE	Shows the GPS message or GPS-A comment included in the position data of the received call.

\*1 These items show the name under the call sign, if programmed.  
 \*2 “FREQUENCY” appears instead of these items when the call was not through a repeater (Simplex call), to show the frequency that was used.  
 \*3 If you have no position data, these items are not displayed.

## ■ DV Memory items

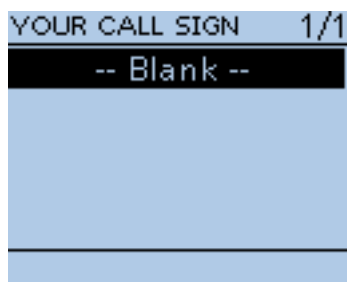

### Your Call Sign

DV Memory > Your Call Sign (YOUR CALL SIGN)

The transceiver has a total of 200 memories to store an individual station destination call sign.

The stored call sign and name are displayed on the YOUR CALL SIGN or RX Record screen.

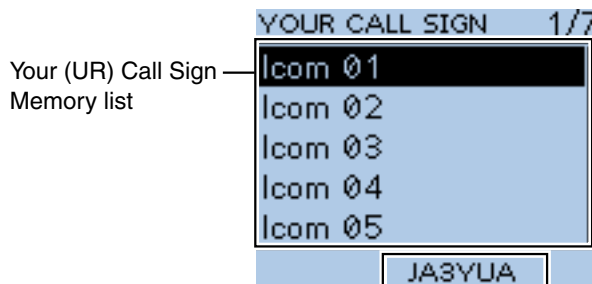

The call sign of the selected station

- The Your (UR) Call Sign can be programmed to the memory using the RX History. (p. 21 of the Basic Instruction)
- See pages 9-40 to 9-43 about how to add, edit or move the Your Call Sign in the memory.

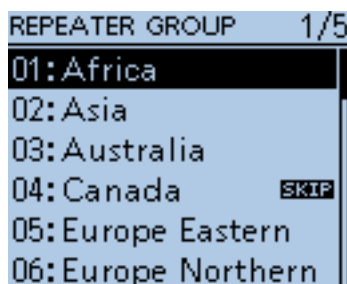

### Repeater List

DV Memory > Repeater List (REPEATER GROUP)

You can store **repeater** information for quick and simple communication when using repeaters.

The transceiver has a total of 750 repeater memory channels, storable in 25 groups (01 to 25).



The call sign of the selected repeater  
The sub name (regional name) of the selected repeater

#### NOTE:

For easy operation, a repeater list is preloaded into your transceiver. However, if the CPU clears all programmed contents (All Reset), the repeater list is also cleared.

We recommend that memory data be backed up using a microSD card, or be saved to a PC using the supplied CS-51 cloning software.

#### About the repeater list:

The repeater list can be downloaded from the Icom website.  
<http://www.icom.co.jp/world/support/download/firm/index.html>

■ DV Memory items (Continued)

**Repeater Group (01 to 25)**

Group name	<b>Repeater</b> group name of up to 16 alphanumeric characters
------------	--

The Skip setting can be turned ON or OFF in the QUICK MENU screen.

**Repeater List**

NAME	Repeater name of up to 16 alphanumeric characters
SUB NAME	Repeater sub name of up to 8 alphanumeric characters
CALL SIGN	Repeater call sign
GW CALL SIGN	Gateway call sign
GROUP	Repeater group where the repeater is assigned
USE(FROM)	Select whether or not to use the repeater as an access repeater (FROM) in the DR mode
FREQUENCY*1	Operating frequency of the access repeater
DUP*1	<b>Duplex</b> setting to use the access repeater
OFFSET FREQ*1	<b>Frequency offset</b> to use the access repeater
POSITION	Position data accuracy level ("None," "Approximate" or "Exact")
LATITUDE*2	Latitude position of the repeater
LONGITUDE*2	Longitude position of the repeater
<b>UTC</b> OFFSET	Time difference between UTC (Universal Time Coordinated) and the local time

\*1 Appears only when USE(FROM) is set to "YES."

\*2 Appears only when POSITION is set to "Approximate" or "Exact."

/// **NOTE:** When the repeater is used for a **simplex** communication, refer to the list below to set the settings.

NAME	Enter the desired name of up to 16 alphanumeric characters
SUB NAME	Enter the desired sub name of up to 8 alphanumeric characters
CALL SIGN	Blank
GW CALL SIGN	—
GROUP	Set the desired repeater group
USE(FROM)	YES
FREQUENCY	Frequency for the Simplex operation
DUP	OFF
OFFSET FREQ	—
POSITION	—
UTC OFFSET	—

## ■ My Station items

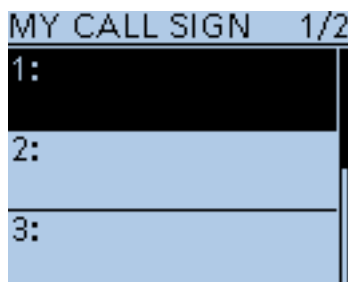

### My Call Sign

My Station > My Call Sign (MY CALL SIGN)

The transceiver has a total of 6 memories to store your own call signs. A call sign of up to 8 digits can be entered.

Also, a note of up to 4 characters, for operating radio type, area, and so on, can be entered.

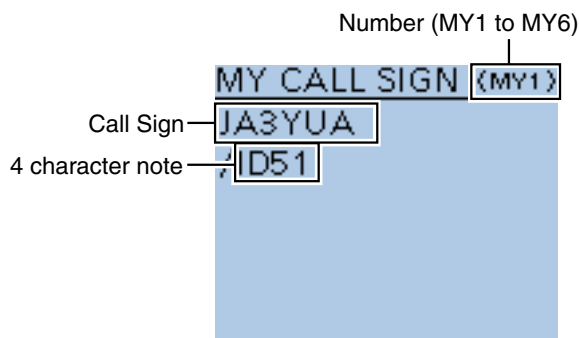

- /// • See page 2 of the Basic Instruction for MY call sign programming.
- /// • To select a different My Call Sign, push D-pad(↑) to select, and then push D-pad(Ent) to set.

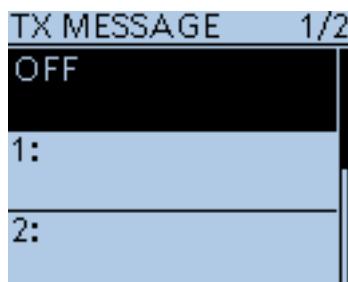

### TX Message

My Station > TX Message (TX MESSAGE)

The transceiver has a total of 5 memories to store short messages for simultaneous transmission in the DV mode.

Enter a message of up to 20 alphanumeric characters for each memory.

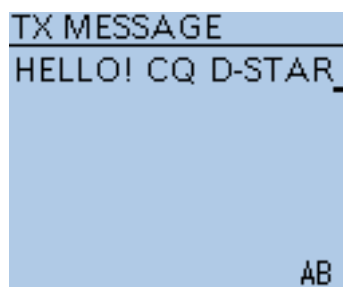

TX Message edit screen

- /// • See page 9-2 for TX message programming.
- /// • To changing the TX Message, push D-pad(↑) to select, and then push D-pad(Ent) to set.
- /// • When no message transmission is necessary, select "OFF."

## ■ DV Set items

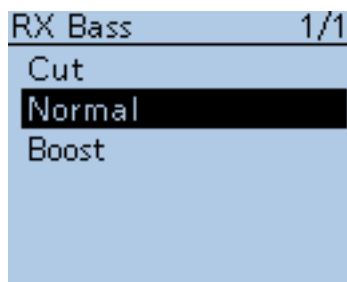

### **RX Bass** (Default: Normal)

DV Set > Tone Control > RX Bass (RX Bass)

Set the DV mode received audio bass filter level to Cut, Normal or Boost.

- Cut : Cuts the bass tone
- Normal : Normal tone level
- Boost : Boosts the bass tone

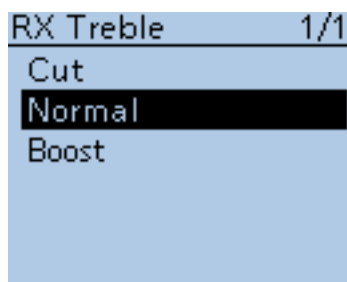

### **RX Treble** (Default: Normal)

DV Set > Tone Control > RX Treble (RX Treble)

Set the DV mode received audio treble filter level to Cut, Normal or Boost.

- Cut : Cuts the treble tone
- Normal : Normal tone level
- Boost : Boosts the treble tone

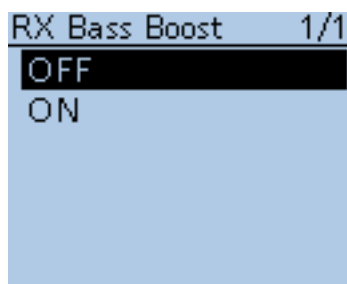

### **RX Bass Boost** (Default: OFF)

DV Set > Tone Control > RX Bass Boost (RX Bass Boost)

Turn the DV mode received audio Bass Boost function ON or OFF.

This function is separate from the “Boost” setting of the RX Bass.

- OFF : Turns the function OFF.
- ON : This function boosts the received audio bass to output it from a speaker, even if the speaker is small.

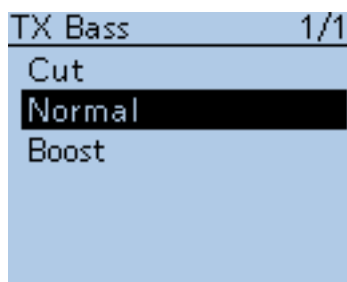

### **TX Bass** (Default: Normal)

DV Set > Tone Control > TX Bass (TX Bass)

Set the DV mode transmit audio bass filter level to Cut, Normal or Boost.

- Cut : Cuts the bass tone
- Normal : Normal tone level
- Boost : Boosts the bass tone

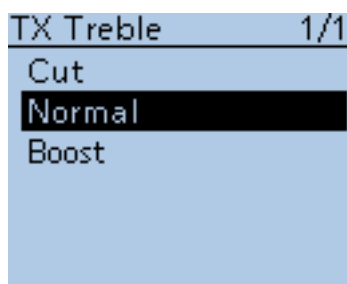

### **TX Treble** (Default: Normal)

DV Set > Tone Control > TX Treble (TX Treble)

Set the DV mode transmit audio treble filter level to Cut, Normal or Boost.

- Cut : Cuts the treble tone
- Normal : Normal tone level
- Boost : Boosts the treble tone



■ DV Set items (Continued)

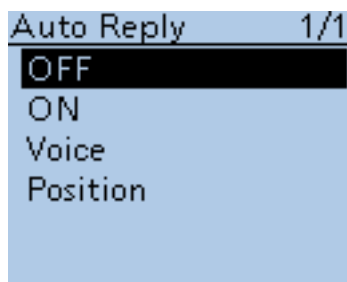

**Auto Reply**

**(Default: OFF)**

DV Set > Auto Reply (Auto Reply)

Set the automatic reply function to ON, OFF, Voice or Position. This function automatically replies to a call addressed to your own call sign, even if you are away from the transceiver.

When "ON" or "Voice" is selected, the automatic reply function is automatically turned OFF when you push [PTT].

When "Position" is selected, the automatic reply function is kept to ON, even if you push [PTT].

- OFF : Turns the function OFF.
- ON : Replies with your own call sign. (No audio reply is sent)
- Voice : Replies with your call sign and any Auto Reply message recorded on the microSD (up to 10 seconds).  
If no microSD card is inserted or no message is recorded, only your call sign is transmitted. The transmitted audio can be monitored.
- Position: Replies with your own call sign and transmits your position using the internal GPS receiver.  
It may take a few seconds to receive your position, and may be late to send the call.
  - When "OFF" or "Manual" is set in "GPS Select," the internal GPS receiver is temporarily turned ON.
  - When "External GPS" is set in "GPS Select," the transceiver transmits your position. But if the external GPS receiver is not connected, the internal GPS receiver will be activated.

**NOTE:**

- ▨ The Power Save function is disabled when "ON" or "Voice" is selected.
- ▨ The Power Save function is enabled when "Position" is selected.

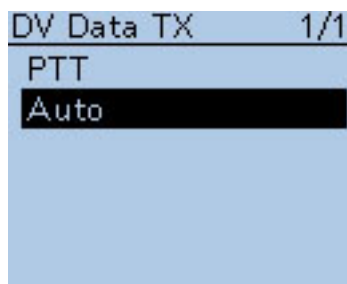

**DV Data TX**

**(Default: Auto)**

DV Set > DV Data TX (DV Data TX)

Select whether to manually or automatically transmit slow-speed data.

- PTT : Push [PTT] to manually transmit the input data.
- Auto : When data is input from a PC through the [DATA] jack, the transceiver automatically transmits it.

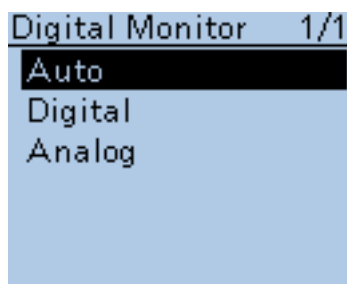

**Digital Monitor**

**(Default: Auto)**

DV Set > Digital Monitor (Digital Monitor)

Select the receive mode when [SQL] is held down in the DV operation mode.

- Auto : Receives in the DV mode or the FM mode, depending on the received signal.
- Digital : Monitors in the DV mode.
- Analog : Monitors in the FM mode.

■ DV Set items (Continued)

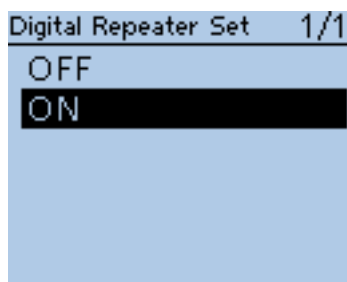

**Digital Repeater Set** (Default: ON)

DV Set > Digital Repeater Set (Digital Repeater Set)

Turn the digital **repeater** setting function ON or OFF.

In any DV mode except for the DR mode, and when accessing a repeater that has a call sign that is different than the transceiver's setting, this function reads the repeater's signal and automatically sets the repeater call sign in R1 and R2.

- OFF : Turns the function OFF.
- ON : Automatically sets the repeater call sign.

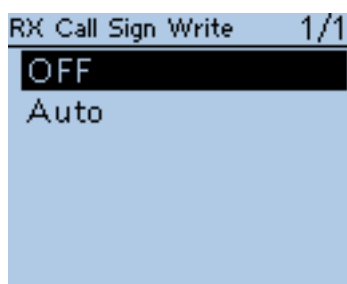

**RX Call Sign Write** (Default: OFF)

DV Set > RX Call Sign Write (RX Call Sign Write)

Set the RX call sign automatic write function to Auto or OFF.

When receiving a call addressed to your own call sign in any DV mode except for the DR mode, this function automatically sets the caller station call sign into "UR."

- OFF : Turns the function OFF.
- Auto : Automatically sets the call sign of the caller station into "UR"

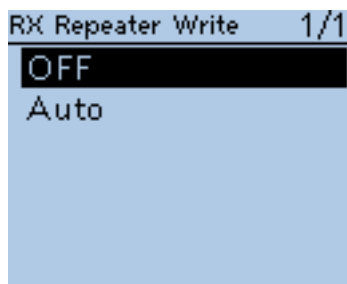

**RX Repeater Write** (Default: OFF)

DV Set > RX Repeater Write (RX Repeater Write)

Set the repeater call sign automatic write function to Auto or OFF.

When receiving a call addressed to your own call sign through a repeater in any DV mode except for the DR mode, this function automatically sets the call sign of the repeater into "R1" or "R2."

- OFF : Turns the function OFF.
- Auto : Automatically sets the call sign of the repeater into "R1" and/or "R2."

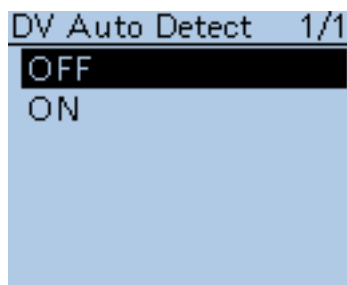

**DV Auto Detect** (Default: OFF)

DV Set > DV Auto Detect (DV Auto Detect)

Turn the DV mode automatic detect function ON or OFF.

If you receive a non-digital signal during DV mode operation, this function automatically switches to the FM mode.

- OFF : Turns the function OFF. The operating mode is fixed to the DV mode.
- ON : Automatically selects the FM mode for temporary operation.

■ DV Set items (Continued)

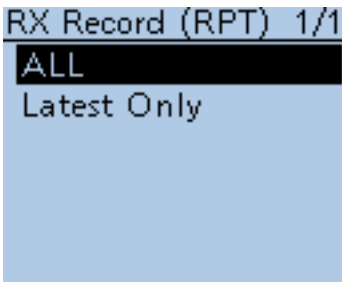

**RX Record (RPT)** (Default: ALL)

DV Set > RX Record (RPT) (RX Record (RPT))

The transceiver can record the data of up to 50 individual calls. When the received signal includes a status message (“UR?” or “RPT?”) that is sent back from the access repeater, you can record up to 50 messages or only the latest one, in the Received Call Record.

- ALL : Records up to 50 calls.
- Latest Only : Records only the latest call.

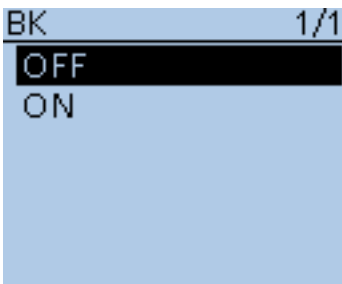

**BK** (Default: OFF)

DV Set > BK (BK)

The BK (Break-in) function allows you to break into a conversation, where the two other stations are communicating with call sign squelch enabled.

- OFF : Turns the function OFF.
- ON : Turns the function ON.  
“BK” appears on the display.

/// **NOTE:** The BK function is automatically turned OFF when transceiver is turned OFF.

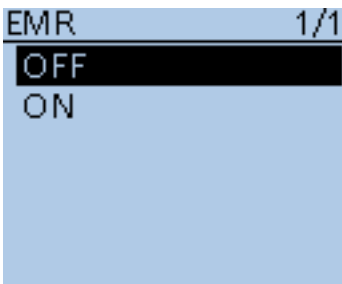

**EMR** (Default: OFF)

DV Set > EMR (EMR)

The EMR communication mode can be used in the digital mode. In the EMR mode, no call sign setting is necessary.

When an EMR mode signal is received, the audio (voice) will be heard at the specified level even if the volume setting level is set to minimum level, or digital call sign/digital code squelch is in use.

- OFF : Turns the function OFF.
- ON : Turns the function ON.  
“EMR ” appears on the display.

/// **NOTE:** The EMR function is automatically turned OFF when transceiver is turned OFF.

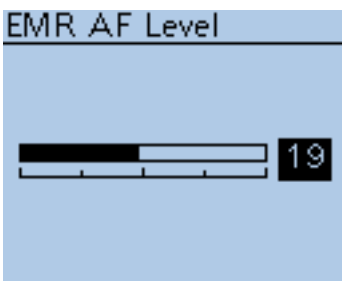

**EMR AF Level** (Default: 19)

DV Set > EMR AF Level (EMR AF Level)

Set the audio output level to between 0 and 39 for when an EMR communication mode signal is received.

When an EMR signal is received, the audio will be heard at the set level, or the [VOL] control level, whichever is higher.

To disable the setting, set it to “0.”

/// **NOTE:** After an EMR signal disappears, the audio level will remain at the EMR level. In this case, rotate [VOL] to adjust the audio level.

## ■ SPEECH items

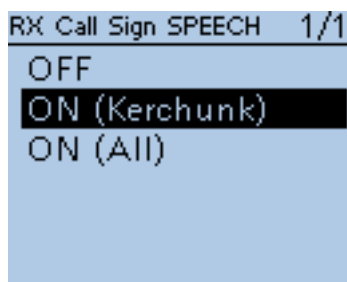

### RX Call Sign SPEECH (Default: ON (Kerchunk))

SPEECH > RX Call Sign SPEECH (RX Call Sign SPEECH)

Turn the RX call sign speech function ON or OFF for calls received in the DV mode.

- OFF : No announcement is made even when a call is received.
- ON (Kerchunk): The caller station's call sign is announced only when it makes a short transmission.
- ON (All) : The caller station's call sign is always announced.

/// **NOTE:** When a call is received during an announcement, the received audio is heard after cancelling the announcement.

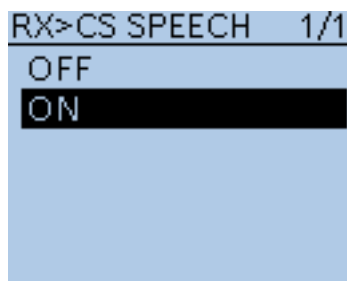

### RX>CS SPEECH (Default: ON)

SPEECH > RX>CS SPEECH (RX>CS SPEECH)

Turn the RX>CS Speech function ON or OFF.

The RX>CS Speech function enables the transceiver to announce the station call sign that is selected from a Received Call Record by pushing **[RX>CS]** and then rotating **[DIAL]**. (p. 9-16)

- OFF : The station call sign is not announced.
- ON : The station call sign is announced.

/// **NOTE:**

- When a call is received during an announcement, the received audio will be muted, and no audio is recorded onto the microSD card.
- If the call sign is announced while recording, the recorded contents are silent during the announcement.

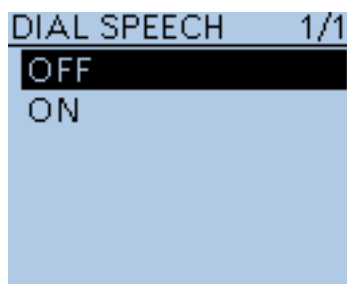

### DIAL SPEECH (Default: OFF)

SPEECH > DIAL SPEECH (DIAL SPEECH)

Turn the Dial Speech function ON or OFF.

The Dial Speech function enables the transceiver to announce the frequency or **repeater** call sign that is selected by rotating **[DIAL]**.

- OFF : The Dial Speech function is OFF.
- ON : The frequency or repeater call sign is announced, 1 second after **[DIAL]** selection.
  - In the VFO, Memory and Call channel modes, the frequency is announced.
  - In the DR mode, the repeater call sign is announced. If **Simplex** is selected, the frequency is announced.

/// **NOTE:** When a call is received during an announcement, the received audio is heard after cancelling the announcement.

■ SPEECH items (Continued)

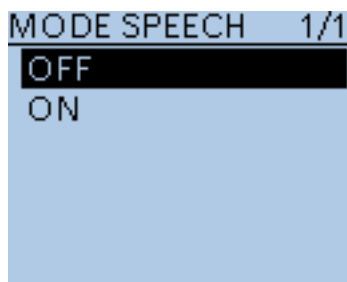

**MODE SPEECH** (Default: OFF)

SPEECH > MODE SPEECH (MODE SPEECH)

Turn the Operating Mode Speech function ON or OFF. When this function is ON, the selected operating mode is announced when the mode switch is pushed.

- OFF : The selected operating mode is not announced.
- ON : The selected operating mode is announced.

**NOTE:**

- While in the DV mode, the recorded contents are silent during the announcement, if the operating mode is announced while recording,
- While in the AM, FM or FM-N mode, the received contents are recorded onto the microSD card, if a call is received during an announcement.
- Even if the VFO scan is running, the operating mode is announced when [MODE]  is pushed.

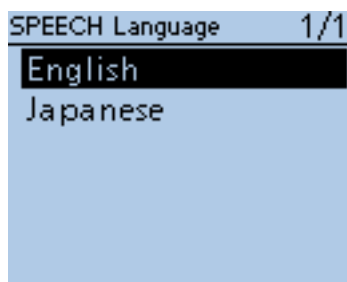

**SPEECH Language** (Default: English)

SPEECH > SPEECH Language (SPEECH Language)

Set the desired speech pronunciation to English or Japanese.

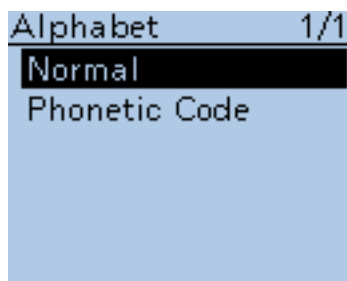

**Alphabet** (Default: Normal)

SPEECH > Alphabet (Alphabet)

Select either “Normal” or “Phonetic Code” to announce the alphabet character.

- Normal : Normal code is used. (for example: A as eh, B as bee)
- Phonetic Code : Phonetic code is used. (for example: A as Alfa, B as Bravo)

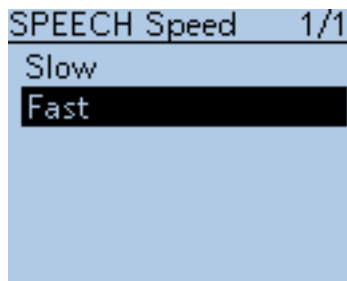

**SPEECH Speed** (Default: Fast)

SPEECH > SPEECH Speed (SPEECH Speed)

Set the speech speed to Low (slow) or High (fast).

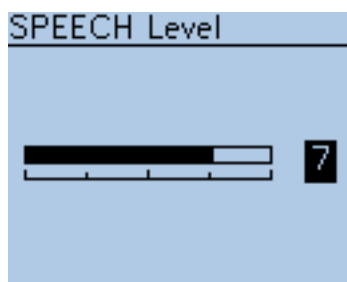

**SPEECH Level** (Default: 7)

SPEECH > SPEECH Level (SPEECH Level)

Enter a volume level number between 0 (OFF), 1 (minimum) and 9 (maximum) for the voice synthesizer.

The voice synthesizer audio output level from the speaker is linked with [VOL] setting from the minimum audio volume up to the set level.

## ■ DTMF/T-CALL items

Programs and sets the **DTMF** tone code and DTMF memory channel for DTMF tone operation.  
See pages 17-8 to 17-12 for details.

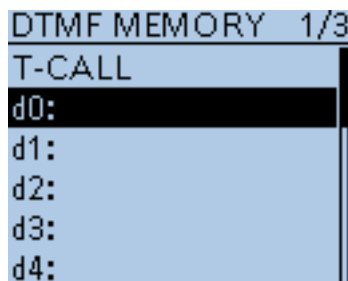

### **DTMF Memory** (Default: d0)

DTMF/T-CALL > DTMF Memory (DTMF MEMORY)

Shows a list of the DTMF memory channels.

- T-CALL : 1750 Hz tone burst signal
- d0 to d# : DTMF memory channel list

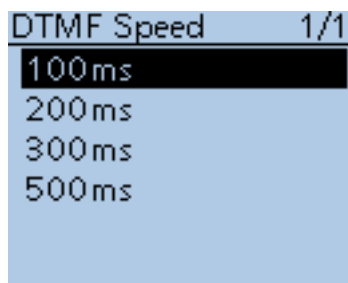

### **DTMF Speed** (Default: 100ms)

DTMF/T-CALL > DTMF Speed (DTMF Speed)

Select the DTMF transfer speed.

- 100ms : Transfer the DTMF codes at about 100 milliseconds per code.  
5 characters per second.
- 200ms : Transfer the DTMF codes at about 200 milliseconds per code.  
2.5 characters per second.
- 300ms : Transfer the DTMF codes at about 300 milliseconds per code.  
1.6 characters per second.
- 500ms : Transfer the DTMF codes at about 500 milliseconds per code.  
1 character per second.

## ■ QSO/RX Log items

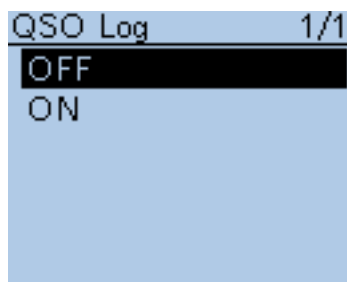

### QSO Log

(Default: OFF)

QSO/RX Log > QSO Log (QSO Log)

Select whether or not to make a communication log on the microSD card. The communication log can be made on a microSD card, and saved in the “csv” format.

Be sure to insert the microSD card into the transceiver before making a communication log.

- OFF : The QSO Log function is OFF.
- ON : The transceiver makes a communication log on the microSD card.  
The transceiver starts making a log with your send contents.

#### NOTE:

- The folder name is automatically created, as [ID-51\QsoLog].
- The file name is automatically created, as shown in the example below:  
Log start date and time: 2012/9/1 15:30:00  
File name: 20120901\_153000.csv
- The log contents cannot be displayed on the transceiver.
- You can see the log contents on a microSD card on a PC.

The log contents are shown below:

Contents	Example		Descriptions
TX/RX	TX	RX	Transmission and reception
Date	12/23/2012 13:51:48	12/23/2012 13:51:48	Date and time the call was started.
Frequency	438.010000	438.010000	Operating frequencies (When <b>Duplex</b> is set, the frequencies of the called are displayed.)
Mode	DV	DV	Operating mode (FM/FM-N/DV)
My Latitude	34.764667	34.764667	Your latitude (unit: degree) (+: North latitude, -: South latitude)
My Longitude	135.375333	135.375333	Your longitude (unit: degree) (+: East longitude, -: West longitude)
My Altitude	50.5	50.5	Your altitude (unit: ft) Records to one decimal place.
RF Power	Mid	(Blank)	TX output power level
S-meter Level	(Blank)	S0	The relative signal strength of the receive signal (in twelve levels)
RPT Call Sign	JP3YHJ A	JP3YHJ A	<b>Repeater</b> call sign (DV mode only)
TX Call Sign	CQCQCQ	(Blank)	TX Call sign (DV mode only)
RX Call Sign	(Blank)	JA3YUA A	RX Call sign (DV mode only)
RX Latitude	(Blank)	34.764667	Caller's latitude, if sent. (unit: degree) (+: North latitude, -: South latitude) Records only when you receive in the DV mode.
RX Longitude	(Blank)	135.375333	Caller's longitude, if sent. (unit: degree) (+: East longitude, -: West longitude) Records only when you receive in the DV mode.
RX Altitude	(Blank)	30.5	Caller's altitude, if sent. (unit: ft) Records only when you receive in the DV mode.

■ QSO/RX items (Continued)

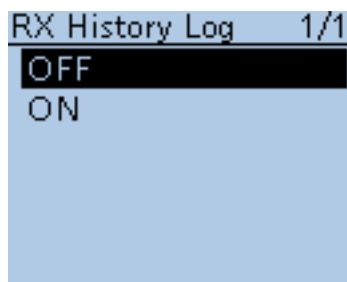

**RX History Log**

(Default: OFF)

QSO/RX Log > RX History Log (RX History Log)

Select whether or not to make a DV mode's receive history log on the microSD card.

The receive history log can be made on a microSD card, and saved in the "csv" format. Be sure to insert the microSD card into the transceiver before making a communication log.

- OFF : The RX History Log function is OFF.
- ON : The transceiver makes a DV mode's receive history log on the microSD card.  
The transceiver starts making a receive history log when you finish to talk.

**NOTE:**

- The folder name is automatically created, as [ID-51\RxLog].
- The file name is automatically created, as shown in the example below:  
Log start date and time: 2012/9/1 15:30:00  
File name: 20120901\_153000.csv
- The log contents cannot be displayed on the transceiver.
- You can see the log contents on a microSD card on a PC.

The log contents are shown below:

Contents	Example	Descriptions
Frequency	438.010000	RX Frequency
Mode	DV	Operating mode (DV is fixed)
Caller	JA3YUA A	Call sign of the caller station
/	ID51	Note after the call sign
Called	CQCQCQ	Call sign of the called station
Rx RPT1	JP3YHH G	Access <b>repeater</b> call sign of the caller station or the gateway repeater call sign of your local area repeater.
Rx RPT2	JP3YHJ A	Access repeater call sign of the called station
Message	Hello CQ D-STAR!	Message included in the received call (up to 20 characters)
Status	(Blank)	Normal: blank, Uplink: UPLINK, Access repeater reply: "UR?" or "RPT?"
Received date	12/23/2012 13:51:48	Date and time the call was received Depending on the setting, the format may differ.
BK	*	BK call: "**", Normal call: Blank
EMR	*	EMR call: "**", Normal call: Blank
Latitude	34.764667	Caller's latitude, if sent. (unit: degree) (+: North latitude, -: South latitude)
Longitude	135.375333	Caller's longitude, if sent. (unit: degree) (+: East longitude, -: West longitude)
Altitude	30.5	Caller's altitude, if sent. (unit: ft)
SSID	-A	Records one of 0, -1 to -15 and -A to -Z.
GPS-A Symbol	Car	Icon: Converts to text None: Code
Course	123	Caller's course (unit: degree)
Speed	23.5	Caller's speed (unit: mph)
GPS Time Stamp		Time data that the caller station acquires the position data
GPS Message	Osaka City/ID-51	Caller is "DV-G": Records the GPS message Caller is "DV-A: Records the GPS-A comment



■ QSO/RX items (Continued)

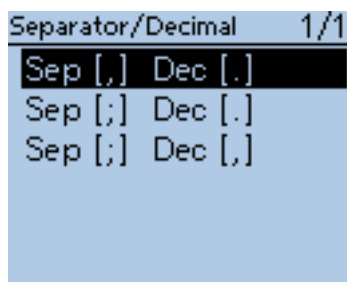

**Separator/Decimal** (Default: Sep [,] Dec [.]\*)

QSO/RX Log > CSV Format > Separator/Decimal (Separator/Decimal)

Select the separator and the decimal character for the CSV format.

- Sep [,] Dec [.] : Separator is “,” and Decimal is “.” for the CSV format.
- Sep [;] Dec [.] : Separator is “;” and Decimal is “.” for the CSV format.
- Sep [;] Dec [,] : Separator is “;” and Decimal is “,” for the CSV format.

\*The default value may differ, depending on the transceiver version.

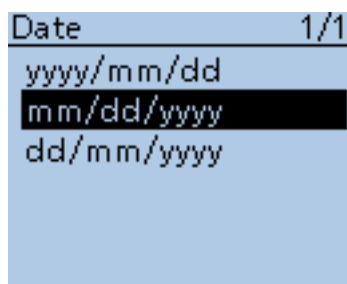

**Date** (Default: mm/dd/yyyy\*)

QSO/RX Log > CSV Format > Date (Date)

Select the date format between “yyyy/mm/dd,” “mm/dd/yyyy” and “dd/mm/yyyy.” (y: year, m: month, d: day)

\*The default value may differ, depending on the transceiver version.

## ■ Function items

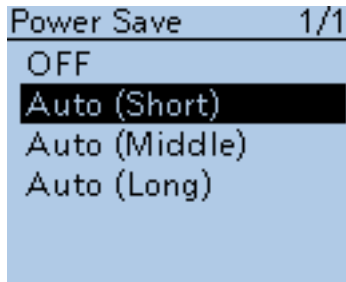

### Power Save

(Default: Auto (Short))

Function > Power Save (Power Save)

Set the power save function to reduce current drain and conserve battery power.

When the power save function is activated, the call sign or the beginning of the signal may not be received correctly.

- OFF : Turns the function OFF.
- Auto (Short) : Sets the Power saving time to “Short”

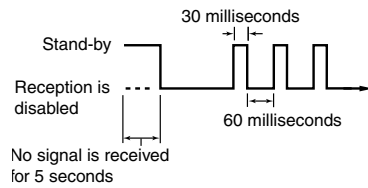

- Auto (Middle) : Sets the Power saving time to “Middle”

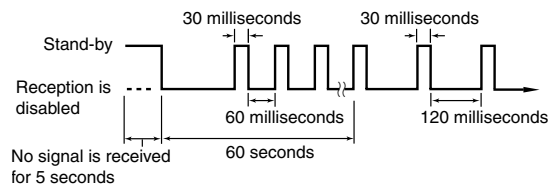

- Auto (Long) : Sets the Power saving time to “Long”

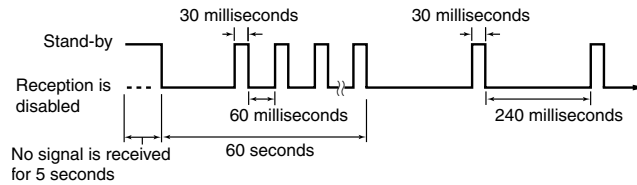

/// **NOTE:** The Power Save function is disabled when using an external power supply, or if the Auto Reply function in the DV mode is set to “ON” or “Voice.”

■ Function items (Continued)

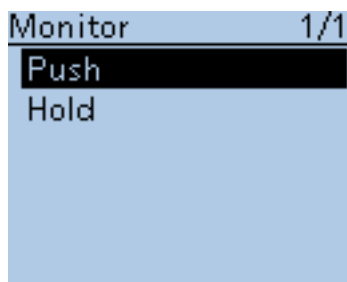

**Monitor** (Default: Push)

Function > Monitor (Monitor)

Select the [SQL] monitor function method.

- Push : Hold down [SQL] to monitor the frequency. Release to stop monitoring.
- Hold : Push [SQL] momentarily to monitor the frequency and push momentarily again to cancel it.

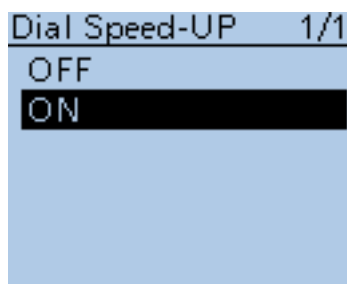

**Dial Speed-UP** (Default: ON)

Function > Dial Speed-UP (Dial Speed-UP)

Turn the dial speed acceleration ON or OFF.

The dial speed acceleration automatically speeds up the tuning dial speed when you rapidly rotate [DIAL].

- OFF : Turns the function OFF.
- ON : Turns the function ON.

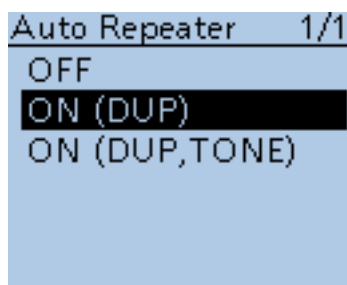

**Auto Repeater**

Function > Auto Repeater (Auto Repeater)

This item appears only in the Korean and U.S.A. version transceivers

The auto **repeater** function automatically turns the **duplex** operation and tone encoder\* ON or OFF.

The offset and repeater tone\* are not changed by the auto repeater function. Reset these setting values, if necessary.

**For Korean versions**

- OFF : Turns the function OFF.
- ON : Turns ON the duplex operation and tone encoder\*. (Default)

**For U.S.A. version**

- OFF : Turns the function OFF.
- ON (DUP) : Turns ON the duplex operation only. (Default)
- ON (DUP, TONE) : Turns ON the duplex operation and tone encoder\*.

\*The tone encoder will not be turned ON in the DV mode.

■ Function items (Continued)

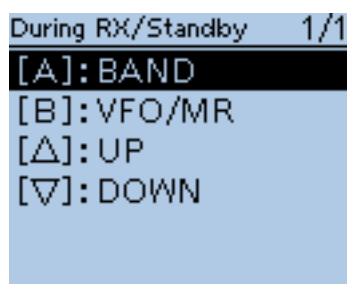
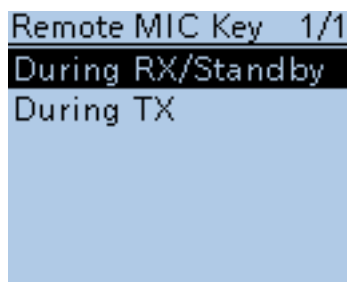

Default for “During RX/Standby”

**Volume level adjustment while monitoring:**

- When [VOL UP]/[VOL DOWN] are assigned, push these keys to adjust.
- When [VOL UP]/[VOL DOWN] are not assigned, but [UP]/[DOWN] are assigned, push these keys to adjust.
- When [VOL UP]/[VOL DOWN]/[UP]/[DOWN] are not assigned, push [Δ]/[▽] to adjust, if [Monitor (Push)] or [Monitor (Hold)] is not assigned to [Δ]/[▽].

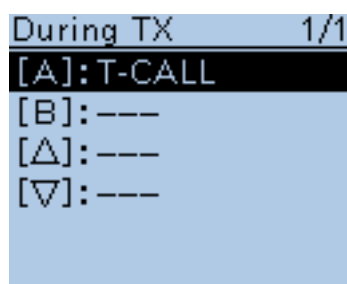

Default for “During TX”

**Remote MIC Key**

Function > Remote MIC Key (Remote MIC key)

The function assignments for keys on the optional HM-75LS SPEAKER-MICROPHONE can be changed for simple remote control operation.

• **During RX/Standby:**

Function	Description
---	No function
UP	Push to increase the frequency, Memory channel, repeater or station call sign.
DOWN	Push to decrease the frequency, Memory channel, <b>repeater</b> or station call sign.
VOL UP	Push to turn up the volume level.
VOL DOWN	Push to turn down the volume level.
Monitor (Push)	Hold down [SQL] to monitor the frequency. Release to stop monitoring.
Monitor (Hold)	Push [SQL] momentarily to monitor the frequency and push momentarily again to cancel it.
CALL	Push to select a call channel.
MR (000 CH)	In the Memory mode, push to select memory channel 000.
MR (001 CH)	In the Memory mode, push to select memory channel 001.
VFO/MR	Push to toggle between the VFO mode and the Memory mode.
DR	Push to select the DR mode.
FROM (DR)	In the DR mode, push to select “FROM.”
TO (DR)	In the DR mode, push to select “TO.”
Home CH	Push to directly select the Home CH that is set to the selected mode (VFO/Memory/DR). While in the CALL CH or weather channel mode, or when no Home CH is set, an error beep sounds.
BAND	Push to select an operating band.
SCAN	Hold down for 1 second to start a scan. Push to stop the scan.
Temporary Skip	Push to set the frequency to be skipped during scanning. The selected frequencies are temporarily skipped during scanning for faster scanning.
RX>CS	Hold down for 1 second to set the last calling station call sign to “TO” (destination).
SPEECH	Hold down for 1 second to announce the frequency, operating mode or call sign. - In the VFO, Memory and Call channel mode, the frequency and the operating mode are announced. - In the DR mode, the call sign is announced. If <b>Simplex</b> is selected, the frequency is announced.
Voice TX	Push to transmit the voice audio recorded on the microSD. Hold down for 1 second to repeatedly transmit the voice audio.

• **During TX:**

Function	Description
---	No function
VOL UP	Push to turn up the volume level.
VOL DOWN	Push to turn down the volume level.
Voice TX	Push to transmit the voice audio recorded on the microSD. Hold down for 1 second to repeatedly transmit the voice audio. - To make a repeat transmission, [PTT] must be released.
T-CALL	Push to transmit a 1750 Hz tone.

■ Function items (Continued)

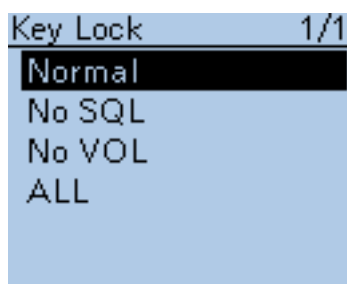

**Key Lock** (Default: Normal)

Function > Key Lock (Key Lock)

Select the key lock type when the Key Lock function is activated.

- Normal : All keys and dials except [SQL] and [VOL] are locked.
- No SQL : All keys and dials except [SQL] is locked.
- No VOL : All keys and dials except [VOL] is locked.
- ALL : All keys and dials are locked.

/// **NOTE:** Regardless of the setting, the [PWR], [PTT] and [MENU] (lock function only) are still accessible when the lock function is activated.

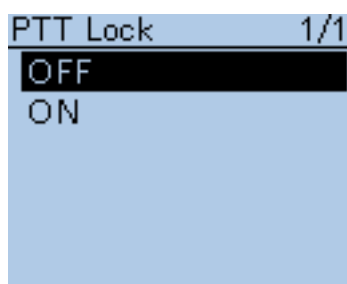

**PTT Lock** (Default: OFF)

Function > PTT Lock (PTT Lock)

Turn the PTT lock function ON and OFF.

To prevent accidental transmissions, this function disables [PTT].

- OFF : Turns the function OFF.
- ON : Turns the function ON.

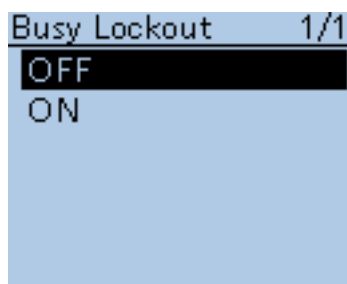

**Busy Lockout** (Default: OFF)

Function > Busy Lockout (Busy Lockout)

Turn the busy lockout function ON or OFF.

This function inhibits transmission while receiving a signal, or when the **scquelch** is open.

- OFF : Turns the function OFF.
- ON : Turns the function ON.

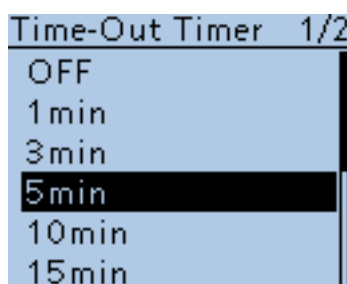

**Time-Out Timer** (Default: 5min)

Function > Time-Out Timer (Time-Out Timer)

To prevent accidental prolonged transmission, the transceiver has a time-out timer.

The function inhibits continuous transmissions longer than the set time period.

- OFF : Turns the function OFF.
- 1 to 30 min : The transmission is cut OFF after the set time period ends (1, 3, 5, 10, 15 or 30 minutes).

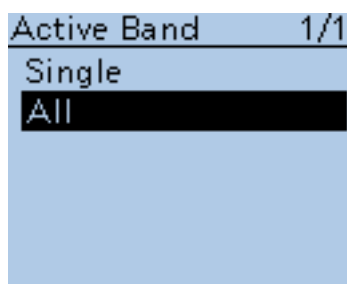

**Active band** (Default: All)

Function > Active Band (Active Band)

Allows continuous frequency selection of the operating frequency across all bands using [DIAL].

- Single : The operating frequency can be selected within the current band.
- ALL : The operating frequency can be continuously selected.

/// **NOTE:**  
 /// When "Single" is selected, push [QUICK] <sup>QUICK</sup> <sub>SPCH</sub> to show the quick menu, and then select "BAND" for another band selection.  
 /// This setting is for the [DIAL] operation, so all frequencies will be scanned.

■ Function items (Continued)

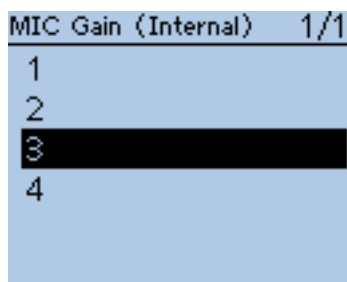

**MIC Gain (Internal)** **(Default: 2)**

Function > MIC Gain (Internal) (MIC Gain (Internal))

Set the internal microphone sensitivity to between 1 (minimum sensitivity) and 4 (maximum sensitivity), to suit your preference. Higher values make the microphone more sensitive to your voice.

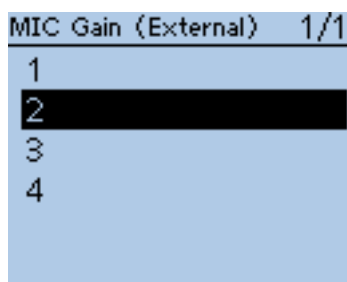

**MIC Gain (External)** **(Default: 2)**

Function > MIC Gain (External) (MIC Gain (External))

Set the external microphone sensitivity to between 1 (minimum sensitivity) and 4 (maximum sensitivity), to suit your preference. Higher values make the microphone more sensitive to your voice. The external microphone is connected to the [MIC/SP] jack.

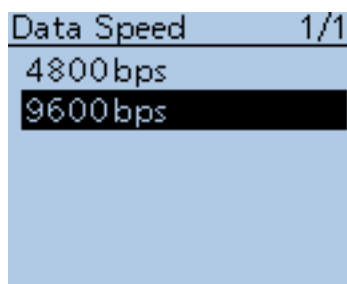

**Data Speed** **(Default: 9600bps)**

Function > Data Speed (Data Speed)

Select the data transmission speed for low-speed data communication, or between the [DATA] jack and external modules like a GPS receiver, and so on, to 4800 bps or 9600 bps.

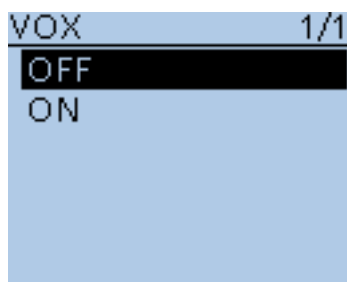

**VOX** **(Default: OFF)**

Function > VOX > VOX (VOX)

Turn the VOX function ON or OFF. The VOX (Voice Operated Transmission) function starts transmission without pushing [PTT] when you speak into the microphone; then, automatically returns to receive when you stop speaking. The VOX function requires an optional headset. (p. 18-3)

- OFF : Turns the function OFF.
- ON : Starts transmission without pushing [PTT] when you speak into the microphone; then automatically returns to receive when you stop speaking.

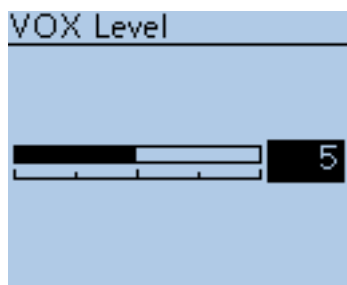

**VOX Level** **(Default: 5)**

Function > VOX > VOX Level (VOX Level)

Set the VOX gain level to between 1 and 10 or OFF. Higher values make the VOX function more sensitive to your voice. To turn the VOX function OFF, select "OFF."

- OFF : Turns the VOX function OFF.
- 1 to 10 : 1: The minimum sensitivity.  
10: The maximum sensitivity.

■ Function items (Continued)

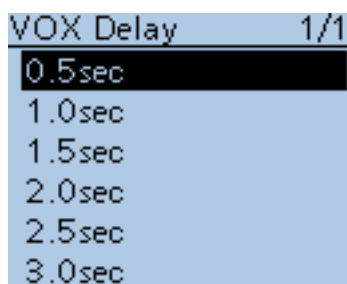

**VOX Delay** **(Default: 0.5sec)**

Function > VOX > VOX Delay (VOX Delay)

Set the VOX Delay to 0.5, 1.0, 1.5, 2.0, 2.5 or 3.0 seconds. The VOX Delay is the amount of time the transmitter stays ON after you stop speaking before the VOX switches to receive.

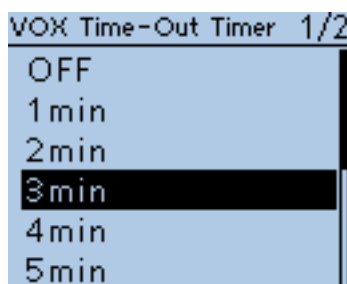

**VOX Time-Out Timer** **(Default: 3min)**

Function > VOX > VOX Time-Out Timer (VOX Time-Out Timer)

Set the VOX Time-Out Timer to 1, 2, 3, 4, 5, 10 or 15 minutes to prevent an accidental prolonged transmission.

To disable the function, set it to "OFF."

- OFF : Turns the function OFF.
- 1, 2, 3, 4, 5, 10 or 15 min : If a continuous transmission exceeds the set period, the transmission will be cut off.

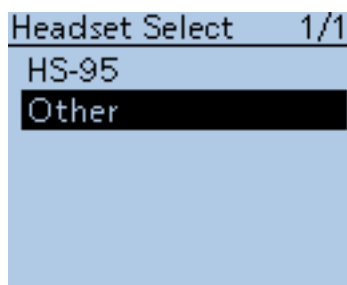

**Headset Select** **(Default: Other)**

Function > VOX > Headset Select (Headset Select)

Select the headset type to be connected.

- HS-95 : Select when the HS-95 is connected.
- Other : Select when the HS-94 or HS-97 is connected.

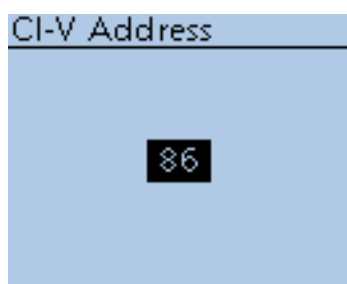

**CI-V Address** **(Default: 86)**

Function > CI-V > CI-V Address (CI-V Address)

To distinguish equipment, each CI-V transceiver has its own Icom standard address in hexadecimal code.

The ID-51A/E's default address is 86.

When 2 or more ID-51A/Es are controlled through a PC at the same time, set a different address for each device between 01h and DFh (hexadecimal).

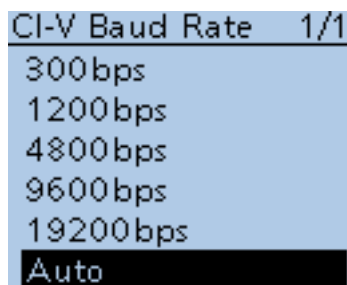

**CI-V Baud Rate** **(Default: Auto)**

Function > CI-V > CI-V Baud Rate (CI-V Baud Rate)

Set the CI-V data transfer speed to 300, 1200, 4800, 9600, 19200 bps or Auto.

When "Auto" is selected, the baud rate is automatically set according to the data rate of the controller.

■ Function items (Continued)

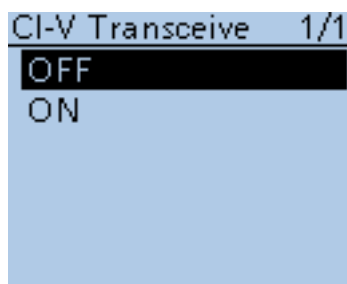

**CI-V Transceive** **(Default: OFF)**

Function > CI-V > CI-V Transceive (CI-V Transceive)

Turn the CI-V Transceive function ON or OFF.

- OFF : Turns the function OFF.
- ON : When you change a setting on the transceiver, the same change is automatically set on other connected transceivers or receivers, and vice versa.

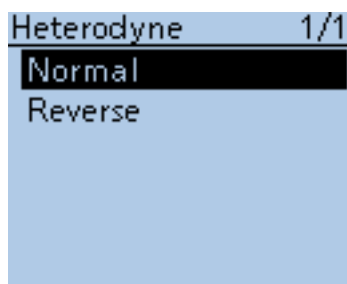

**Heterodyne** **(Default: Normal)**

Function > Heterodyne (Heterodyne)

Set the 1st Local Oscillator frequency.

Depending on a combination of the two operating frequencies in the VHF/UHF Dualwatch mode, the transceiver might generate a spurious signal on a specific receive frequency. This may cause the S-meter to fluctuate, even when no signal is received, for example.

If this occurs, the Heterodyne function may help. The Heterodyne function shifts the 1st Local Oscillator frequency to the opposite side of the signal to change the frequency combination.

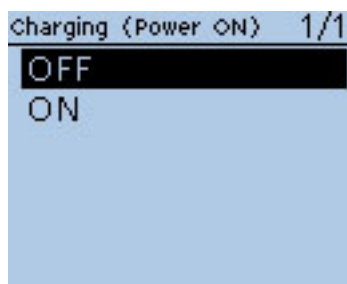

**Charging (Power ON)** **(Default: OFF)**

Function > Charging (Power ON) (Charging (Power ON))

When the battery pack is attached, and the optional CP-12L, CP-19R or OPC-254L external DC power cable is connected, this function enables charging the transceiver's battery even if the power is ON.

- OFF : The transceiver's battery cannot be charged when the power is ON.
- ON : The transceiver's battery can be charged even if the power is ON.



## ■ Display items

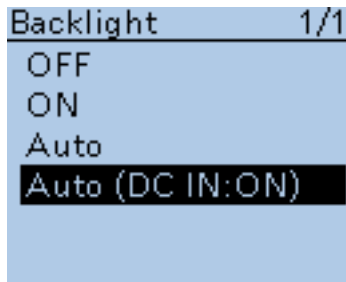

### Backlight

(Default: Auto (DC IN:ON))

Display > Backlight (Backlight)

Select the transceiver backlight option.

- OFF : The backlight does not light.
- ON : The backlight lights continuously.
- Auto : The backlight lights when an operation is performed, and goes out after the time period set in the Backlight Timer.
- Auto (DC IN:ON) : The backlight lights when an operation is performed, and goes out after the time period set in the Backlight Timer, but lights continuously while operating with an external DC power source.

/// **NOTE:**

While in the exclusive GPS logger mode, the transceiver uses the “Auto” setting even if “ON” or “Auto (DC IN:ON)” is selected.

When [PWR] is pushed, the backlight lights for the set period of time (set in “Backlight Timer”) when “Auto” or “Auto (DC-IN:ON)” is selected.



### Backlight Timer

(Default: 5sec)

Display > Backlight Timer (Backlight Timer)

Select the backlight lighting time period to between 5 and 10 seconds.

Depending on the Backlight option, the backlight lights for this set period, and then automatically goes out.

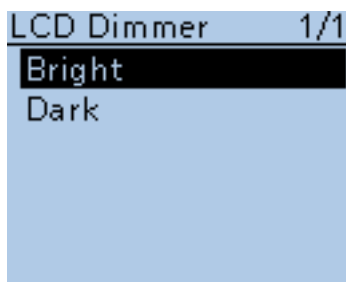

### LCD Dimmer

(Default: Bright)

Display > LCD Dimmer (LCD Dimmer)

Select the LCD backlight brightness level between Bright and Dark.

- Bright : The LCD backlight brightness level is bright.
- Dark : The LCD backlight brightness level is dim.

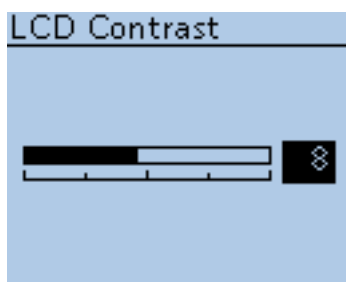

### LCD Contrast

(Default: 8)

Display > LCD Contrast (LCD Contrast)

Set the contrast of the LCD.

Set the level between 1, the lowest contrast, and 16, the highest.

■ Display items (Continued)

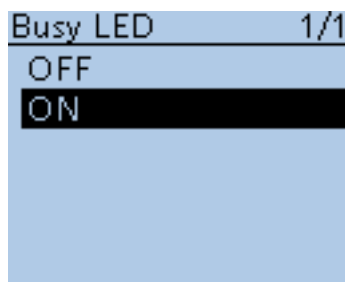

**Busy LED**

**(Default: ON)**

Display > Busy LED (Busy LED)

The TX/RX indicator lights green while receiving a signal, or the squelch is open. It can be turned OFF to conserve battery power, if desired.

- OFF : The indicator does not light, even if a signal is received.
- ON : The indicator lights green while receiving a signal, or the squelch is open.

/// **NOTE:** The indicator lights red while transmitting, regardless of the setting.

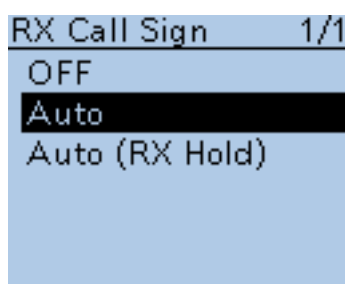

**RX Call Sign**

**(Default: Auto)**

Display > RX Call Sign (RX Call Sign)

When a call is received, select whether or not to display the call sign of the caller station.

- OFF : Turns the function OFF.
- Auto : The caller station's call sign automatically scrolls once, and then disappears.
- Auto (RX Hold) : The caller station's call sign automatically scrolls once, and then remains on the LCD until the signal disappears.



(Example : When receiving a call from "JM1ZLK")

/// **NOTE:** When "Auto" or "Auto (RX Hold)" is selected, and if the call sign and name of the caller station is programmed in Your Call Sign screen, the programmed name is displayed after showing the call sign.

■ Display items (Continued)

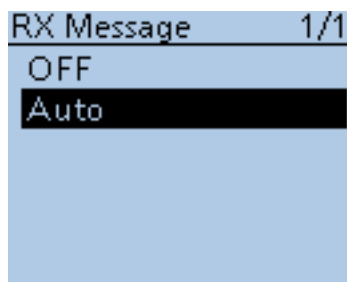

**RX Message**

**(Default: Auto)**

Display > RX Message (RX Message)

Select whether or not to display and scroll a received message.

- OFF : Does not display the message.  
To check the message, hold down [CD] for 1 second to display the call record.
- Auto : Automatically displays and scrolls the message.  
The message is automatically displayed every 30 seconds until the signal disappears.  
When “Auto” or “Auto (RX Hold)” is selected in RX Call Sign Display, the message is displayed after displaying the caller station’s call sign.



(Example : When receiving a message “HELLO CQ”)

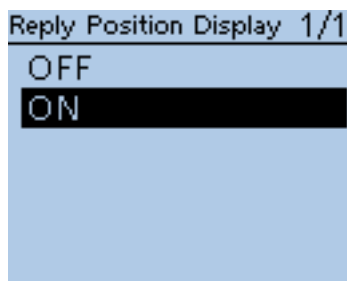

**Reply Position Display**

**(Default: ON)**

Display > Reply Position Display (Reply Position Display)

Select whether or not to display the caller's position data when the data is included in the Auto Reply signal.

- OFF : Does not display the caller's position data.
- ON : Automatically displays the caller's position data.

■ Display items (Continued)

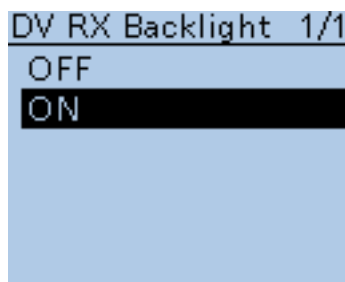

**DV RX Backlight**

**(Default: ON)**

Display > DV RX Backlight (DV RX Backlight)

Turn the DV RX Backlight function ON or OFF.

In the DV mode, this function turns ON the LCD backlight while displaying the calling station's call sign or a received message on the LCD.

- OFF : Turns the function OFF.
- ON : The LCD backlight automatically lights while displaying the calling station's call sign or a received message on the LCD.  
The backlight stays on while the call sign or message is scrolling.

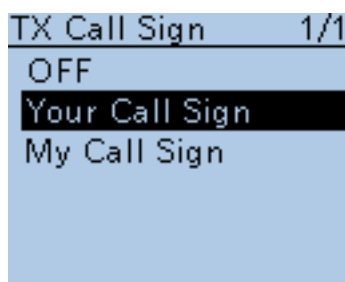

**TX Call Sign**

**(Default: Your Call Sign)**

Display > TX Call Sign (TX Call Sign)

Select whether or not to display your own or the destination station's call sign while transmitting.

- OFF : Turns the function OFF.
- Your Call Sign: Displays and scrolls the destination's call sign.  
When the called station's call sign and name are programmed in your memory, the transceiver shows the name after the call sign in any DV mode except for the DR mode.
- My Call Sign : Displays and scrolls your own call sign.



(Example : Shows the destination's call sign)

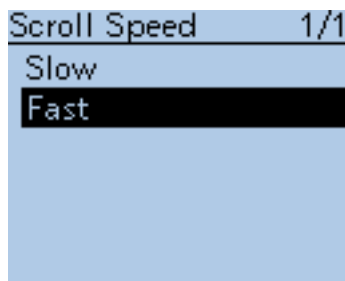

**Scroll Speed**

**(Default: Fast)**

Display > Scroll Speed (Scroll Speed)

This item sets the scrolling speed of the message, call sign, or other text, that is displayed on the transceiver's LCD.

- Slow : The speed is set to slow.
- Fast : The speed is set to fast.

■ Display items (Continued)

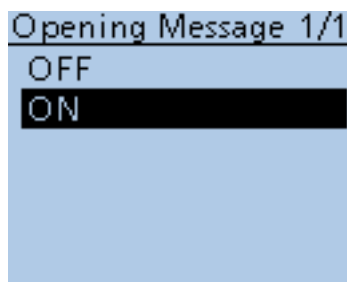

**Opening Message**

(Default: ON)

Display > Opening Message (Opening Message)

Select the opening message that is displayed on the LCD at power ON.

- OFF : Opening message display is skipped.
- ON : Icom logo, MY call sign and the product model (“ID-51A” or “ID-51E”)\* are displayed at power ON.

\*Depending on the version.

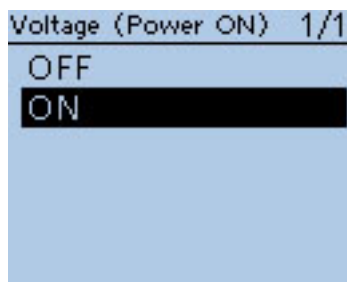

**Voltage (Power ON)**

(Default: ON)

Display > Voltage (Power ON) (Voltage (Power ON))

Select whether or not to display the voltage of the battery or external DC power source on the LCD at power ON.

- OFF : Turns the function OFF.
- ON : When the transceiver is turned ON, displays the voltage of the battery or external DC power source, on the LCD.

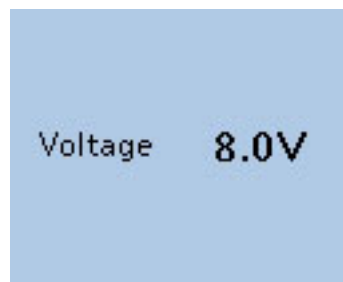

(Example : When the voltage of 8.0 V)

/// **NOTE:** When the voltage is above 15.6V external DC power source, “HI Voltage” is displayed.



**Display Language**

(Default: English)

Display > Display Language (Display Language)

/// **This item will appear only when “Japanese” is selected in System Language. See page 16-77 “Choose your language carefully” about setting cautions.**

Set the screen display language type in the DR mode or Menu mode to English or Japanese.

■ Display items (Continued)

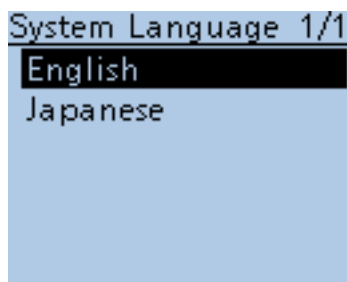

**System Language**

(Default: English)

Display > System Language (System Language)

Set the system language of the transceiver to English or Japanese.

- English : The system language of the transceiver is English.
  - Only alphabetical characters (A to Z, a to z, 0 to 9) and symbols (! " # \$ % & ' ( ) \* + , - . / : ; < = > ? @ [ \ ] ^ \_ ` { | } ~) can be displayed. If Japanese characters (Kanji, Hiragana and Katakana) are included, the LCD shows “=” or “\_” instead of that character. In this case, you can only delete “=” or “\_” in the transceiver’s edit mode.
  - The Display Language item will be hidden.
- Japanese : The system language of the transceiver is Japanese. Kanji, Hiragana and Katakana characters, and the 2-bytes symbols can be displayed on the LCD. To display such characters in the DR mode or Menu mode, Display Language must be set to “Japanese.”

**Choose your language carefully**

When the system language of the transceiver is set to Japanese, the ID-51A/E has the capability to display both English and Japanese characters. HOWEVER, if you select Japanese as the display language (p. 16-76), all menu items throughout the ID-51A/E system will be displayed in only Japanese characters. There will be no English item names. Unless you are fluent in reading Japanese characters, use this feature with extreme caution. If you change the ID-51A/E’s language to Japanese, and can’t understand the menu system in the new setting, you will have to change the language back to English in “Display Language” or “System Language” (this item), or by doing a partial reset of the ID-51A/E CPU. A partial reset will not clear your call sign databases.

To do a partial reset of the CPU, do the following steps:

1. Push [MENU] (MENU).
2. Push D-pad(↑) to select the bottom item, and then push D-pad(Ent).

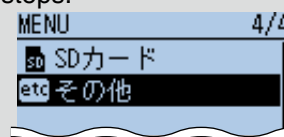
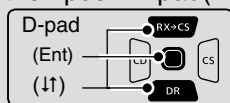

3. Push D-pad(↑) to select the bottom item, and then push D-pad(Ent).

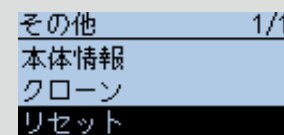

4. Push D-pad(↑) to select the upper item, and then push D-pad(Ent).

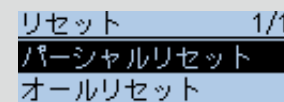

5. The dialog appears. Push D-pad(↑) to select the upper option, and then push D-pad(Ent).
  - The transceiver displays “PARTIAL RESET;” then the partial reset is completed.

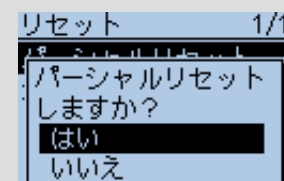

## ■ Sounds items

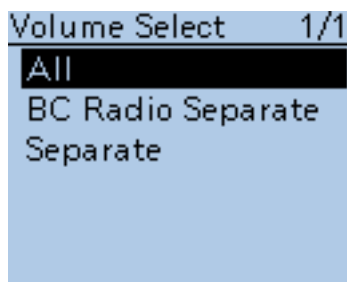

### Volume Select

(Default: All)

Sounds > Volume Select (Volume Select)

Selects to adjust the audio output level of all bands together, all separately, or just the BC Radio separately.

- All : The audio output level of the BC Radio, A band and B band are adjusted together.
- BC Radio Separate : The audio output level of the BC Radio is separately adjusted. The audio output level of A band and B band are adjusted together.
- Separate : The audio output level of the BC Radio, A band and B band are separately adjusted.

**NOTE:** When an EMR signal is received, the audio output level for A band and/or B band may be set to the preprogrammed level in the EMR AF Level, depending on this setting.

- The audio output level for the BC Radio is not changed, because the EMR function is for the DV mode operation.

**When “All” or “BC Radio Separate” is selected:**

The audio output level for A band and B band is set to the programmed level in EMR AF Level.

**When “Separate” is selected:**

Either the audio output level for A band or B band that the signal is received on, is set to the programmed level in EMR AF Level.

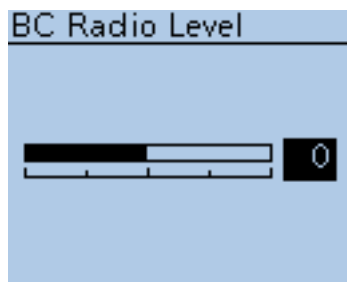

### BC Radio Level

(Default: 0)

Sounds > BC Radio Level (BC Radio Level)

Sets the initial audio output level difference between the BC Radio and the A and B bands when “All” is set in Volume Select.

The adjustable range is +5 higher to -5 lower.

- +5 to +1 : The BC Radio audio output level is higher than the VFO mode audio.
- 0 : The BC Radio audio output level is same as the VFO mode audio.
- -5 to -1 : The BC Radio audio output level is lower than the VFO mode audio.

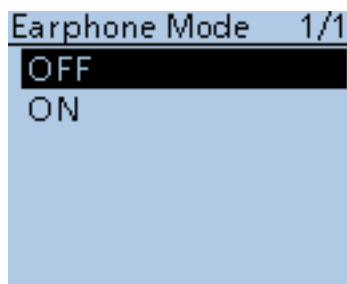

### Earphone Mode

(Default: OFF)

Sounds > Earphone Mode (Earphone Mode)

Turn the earphone mode ON or OFF.

- OFF : Turn OFF the earphone mode.
- ON : Turn ON the earphone mode.

While in the earphone mode, the audio volume level is automatically adjusted to the comfortable level when the optional earphone is connected to the [MIC/SP] jack.

■ Sounds items (Continued)

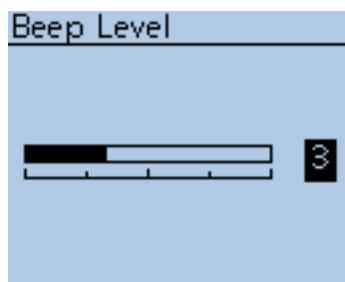

**Beep Level** (Default: 3)

Sounds > Beep Level (Beep Level)

Select a beep audio output level between 0 (OFF), 1 (minimum) and 9 (maximum).

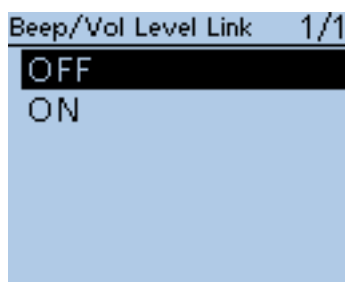

**Beep/Vol Level Link** (Default: OFF)

Sounds > Beep/Vol Level Link (Beep/Vol Level Link)

Select whether or not the beep output level can be adjusted by the [VOL] control.

- OFF : The output level is fixed to the level set in Beep Level.
- ON : The output level can be adjusted by rotating [VOL].

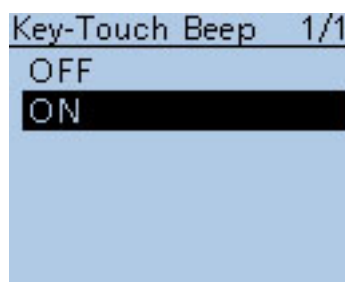

**Key-Touch Beep** (Default: ON)

Sounds > Key-Touch Beep (Key-Touch Beep)

Turn the confirmation beep tones ON or OFF.

- OFF : Turns the function OFF for silent operation.
- ON : A beep sounds when a key is pushed.

/// **NOTE:** The beep tone sounds regardless of this setting when:

- the power is turned ON
- a matched tone signal is received if the pocket beep is activated.
- the transceiver is automatically turned OFF. (The beep sounds before powering OFF.)
- TOT (Time-Out Timer) function is activated. (Approximately 10 seconds before the Time-Out Timer cuts off transmission.)
- the cloning read or write operation starts or finishes.
- a received signal stops the scan. (Scan Stop Beep)
- the communicating station finishes transmitting or the receive signal disappears while in the digital mode operation. (Standby Beep)

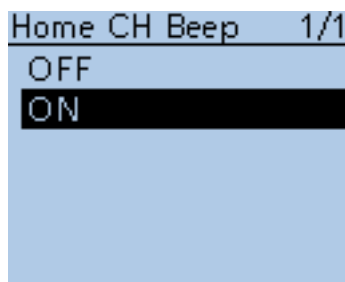

**Home CH Beep** (Default: ON)

Sounds > Home CH beep (Home CH Beep)

Turn the Home CH Beep ON or OFF.

- OFF : No beep.
- ON : When the specified Home CH is selected by rotating [DIAL], a beep sounds.

/// **NOTE:** The Home CH frequency, memory or **repeater** can be respectively selected. (p. 17-5)



■ Sounds items (Continued)

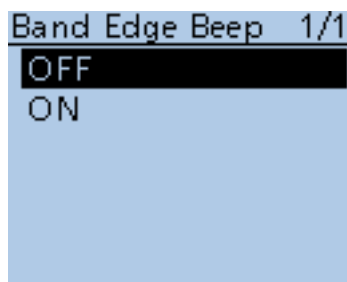

**Band Edge Beep** (Default: OFF)

Sounds > Band Edge Beep (Band Edge Beep)

Turn the Band edge beep ON or OFF.

- OFF : Band edge beep is OFF.
- ON : When you tune into or out of the AIR, VHF and UHF band's frequency range with [DIAL], a beep sounds.

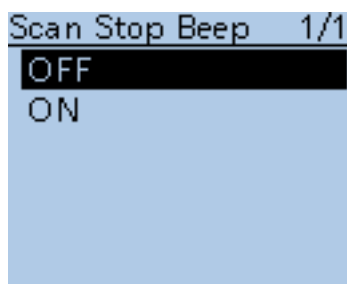

**Scan Stop Beep** (Default: OFF)

Sounds > Scan Stop Beep (Scan Stop Beep)

Turn the scan stop beep ON or OFF.

- OFF : No beep sounds.
- ON : A beep sounds when a received signal stops the scan.

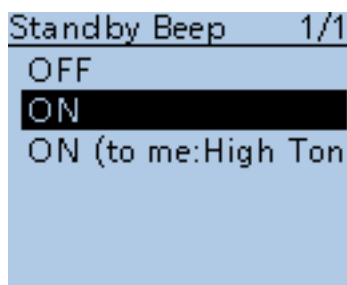

**Standby Beep** (Default: ON)

Sounds > Standby Beep (Standby Beep)

Turn the standby beep function ON or OFF.

This function sounds a beep after a received signal disappears.

- OFF : Turns the function OFF.
- ON : Turns the function ON to sound a beep.
- ON (to me: High Tone) : Turns the function ON to sound a beep. If the signal is addressed to your call sign, a high beep sounds.

- ▨ • The standby beep sounds even when "OFF" is selected in Key-touch beep.
- ▨ • The standby beep output level follows the Beep level setting.

■ Sounds items (Continued)

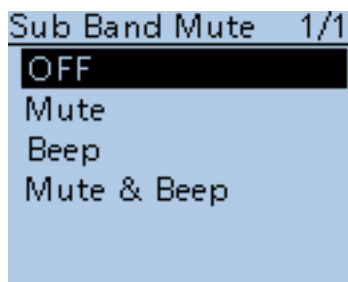

**Sub Band Mute**

**(Default: OFF)**

Sounds > Sub Band Mute (Sub Band Mute)

Select whether or not to mute the SUB band audio signal while receiving on the MAIN band, and/or sound a beep when a signal disappears on the SUB band.

- OFF : Disables the SUB band mute function.
- Mute : While receiving on the MAIN band, the SUB band audio signal is muted.
- Beep : When a signal disappears on the SUB band, a beep sounds.  
The beep sounds even if no signal is received on the MAIN band.
- Mute & Beep : While receiving on the MAIN band, the SUB band audio signal is muted.  
While receiving on the SUB band, and a signal disappears, a beep sounds.  
- The beep sounds even if no signal is received on the MAIN band.

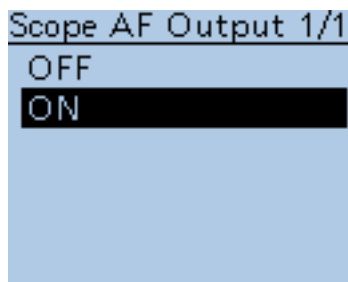

**Scope AF Output**

**(Default: ON)**

Sounds > Scope AF Output (Scope AF Output)

Select the audio output option during a sweep by the Band Scope function.

- OFF : No audio is heard during the sweep.
- ON : The audio is heard during the sweep.

## ■ Time set items



### Date/Time

Time Set > Date/Time (DATE/TIME)

Manually set the date and time that is displayed on the right hand corner of the screen. The time is displayed in the 24 hour format.

#### Setting the date

① Push D-pad(↑), and then push D-pad(Ent) to select “DATE”.

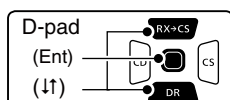

② Push **CD** and **CS** to move the cursor, and then select between year, month and day to change.

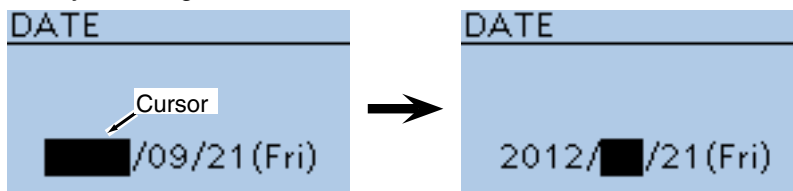

③ Rotate [DIAL] to select each number.

④ Repeat steps ② and ③ to enter the year, month and day, and then push D-pad(Ent).

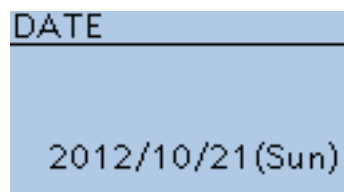

#### Setting the time

① Push D-pad(↑), and then push D-pad(Ent) to select “TIME”.

② Push **CD** and **CS** to move the cursor, and then select between hour and minute to change.

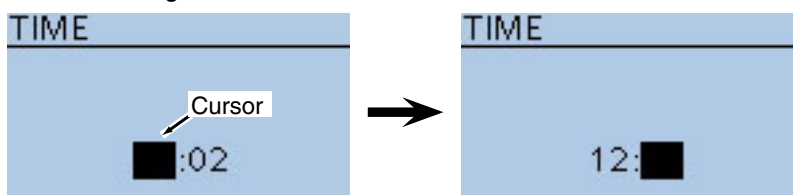

③ Rotate [DIAL] to select each number.

④ Repeat steps ② and ③ to enter the hour and minute, and then push D-pad(Ent).

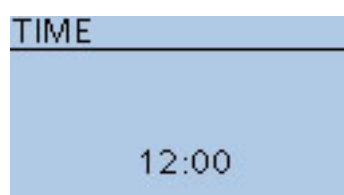

■ Time set items (Continued)

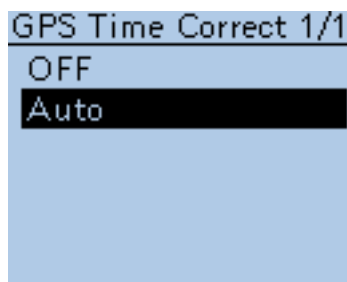

**GPS time correct** **(Default: Auto)**

Time Set > GPS Time Correct (GPS Time Correct)

This function can correct its time by using the time information that a GPS sentence contains.

It is corrected by calculating the received **UTC** (Universal Time of Coordinated) time and the set [UTC Offset].

- OFF : The function is OFF.
- Auto : The function is ON.



**UTC Offset** **(Default: ±0:00)**

Time Set > UTC Offset (UTC Offset)

Set the time difference between UTC (Universal Time Coordinated) and the local time to between -14:00 and +14:00 in 00:05 steps.

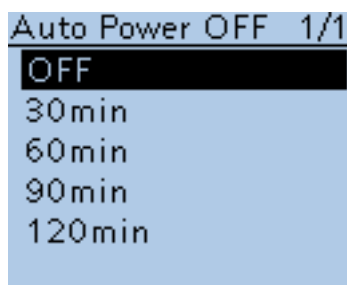

**Auto Power OFF** **(Default: OFF)**

Time Set > Auto Power OFF (Auto Power OFF)

This function automatically turns OFF the power after no operation has not been performed for the preprogrammed time.

- OFF : Turns the function OFF.
- 30 - 120 min : Select the desired Auto Power OFF time between 30, 60, 90 and 120 minutes.

## ■ SD Card items

Settings and functions for microSD card.  
See Section 2 for details.

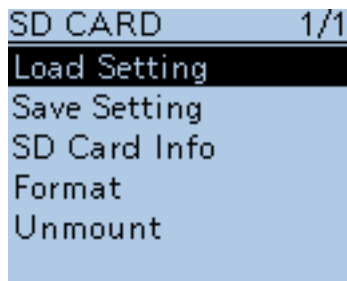

### Load Setting

---

SD Card > Load Setting (LOAD SETTING)

Select from the list when you load the setting file.

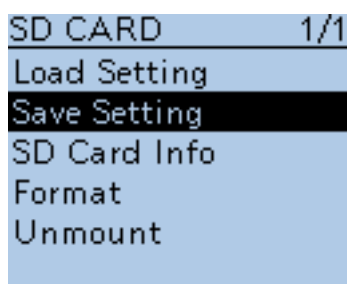

### Save Setting

---

SD Card > Save Setting (SAVE SETTING)

Save the setting file.

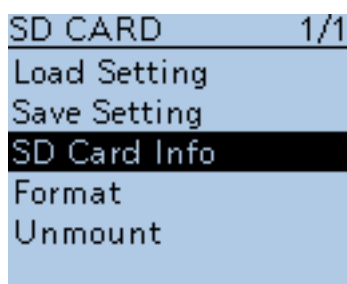

### SD Card Info

---

SD Card > SD Card Info (SD CARD INFO)

Displays the SD card's free space and its remaining recording time.

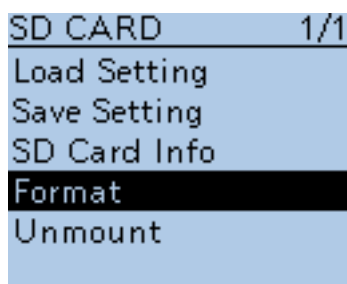

### Format

---

SD Card > Format

Formats the microSD care, deleting all data.

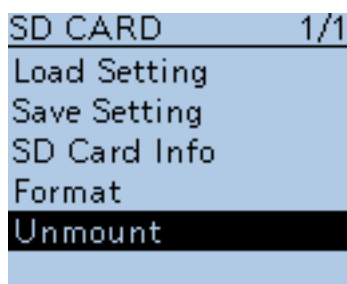

### Unmount

---

SD Card > Unmount

Electrically unmounts the microSD card while the power is ON.

## Others items

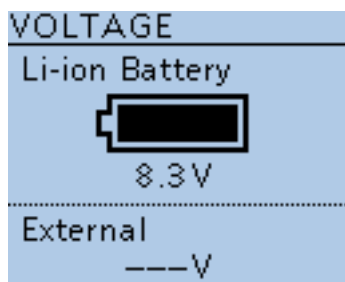

### Voltage

Others > Information > Voltage (VOLTAGE)

Shows the battery voltage of the attached Li-ion battery pack or external power supply.

When the Li-ion battery pack is attached, the remaining battery voltage is shown in eleven level steps.

When the optional battery case is attached, the battery voltage is shown.

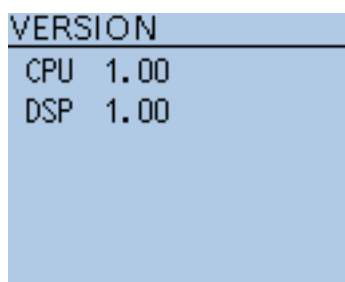

### Version

Others > Information > Version (VERSION)

Shows the transceiver firmware's version number.

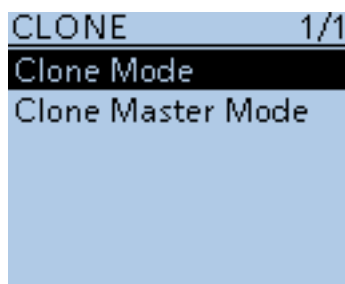

### Clone Mode

Others > Clone > Clone Mode

Select to read or write the CS-51 data from or to the PC, and/or to receive data from a Master transceiver.

See page 17-21 for details.

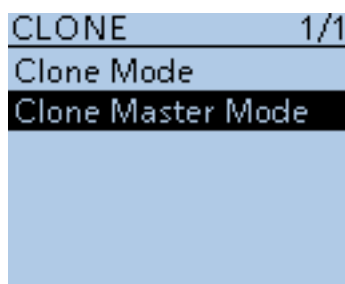

### Clone Master Mode

Others > Clone > Clone Master Mode

Select to write your ID-51A/E (Master) data to another ID-51A/E (Sub).

See page 17-21 for details.

■ Other items (Continued)

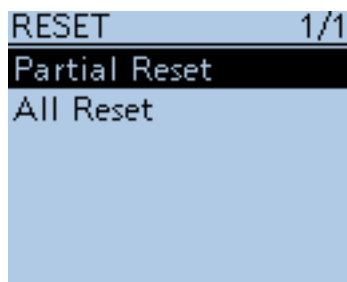

### Partial Reset

Others > Reset > Partial Reset

A Partial reset resets operating settings to their default values (VFO frequency, VFO settings, menu contents) without clearing the items below:

- Memory channel contents
- Scan Edge contents
- Call channel contents
- Call sign memories
- Message data
- DTMF memory contents
- GPS Memory contents
- Repeater list
- BC Radio Memory

① After selecting "Partial Reset," the "Partial Reset?" dialog appears. Push D-pad(↑) to select "Yes," and then push D-pad(Ent).

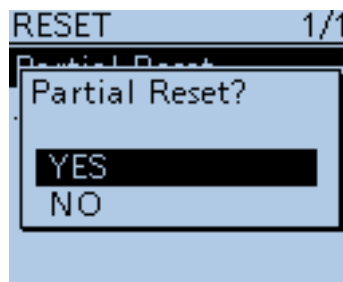

② The transceiver displays "PARTIAL RESET," then the partial reset is completed.

■ Other items (Continued)

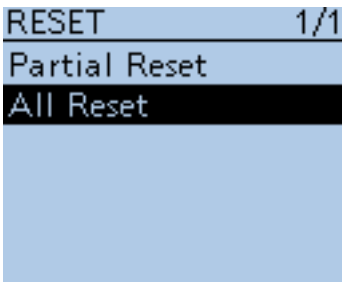

**All Reset**

Others > Reset > All Reset

Reset the CPU, if the internal CPU malfunctions due to static electricity, and so on. All reset clears all programming and returns all settings to their factory defaults (including the programmed data you purchased). Therefore, after the All resetting, you cannot use the transceiver in the DR mode until reprogramming the **repeater** list.

**✓ Recommend!**

Before the All resetting, we recommend you save the programmed data you purchased onto a micro SD card. See page 2-5 for details.

- ① After selecting "All Reset," the "All Reset?" dialog appears. Push D-pad(t) to select "Yes," and then push D-pad(Ent).
- ② The "Clears all settings and memories. Disables the DR mode." dialog appears. Push D-pad(t) to select "Yes," and then push D-pad(Ent).

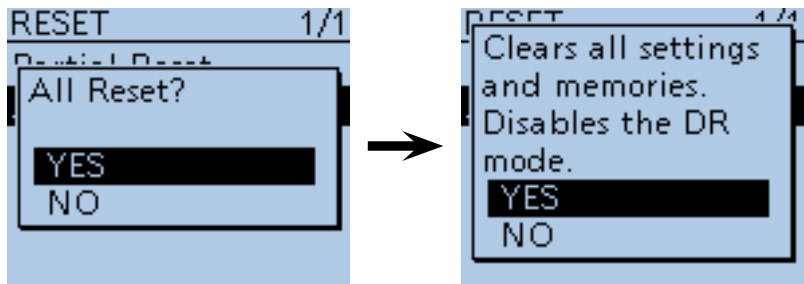

- ③ The transceiver displays "ALL RESET," then the partial reset is completed.



## Section 17 OTHER FUNCTIONS

---

■ Voice TX function.....	17-2
◇ Recording.....	17-2
◇ The recorded voice audio playing back.....	17-2
◇ To transmit the recorded voice audio.....	17-3
◇ Repeat Time setting.....	17-4
◇ TX Monitor function.....	17-4
■ Home CH Beep function.....	17-5
◇ Home CH setting.....	17-5
◇ Home CH operation.....	17-5
■ Speech function.....	17-6
◇ [DIAL] speech function setting.....	17-6
◇ Mode speech function setting.....	17-7
■ Using the DTMF memory.....	17-8
◇ DTMF code programming.....	17-8
◇ Monitoring the stored DTMF code.....	17-9
◇ DTMF code transmission.....	17-10
◇ DTMF code transmission (Direct Input).....	17-11
◇ Setting DTMF transfer speed.....	17-12
■ Tone squelch operation.....	17-13
◇ Tone squelch frequency setting and operation.....	17-13
■ DTCS squelch operation.....	17-15
◇ DTCS code setting and operation.....	17-15
■ Cloning function.....	17-17
◇ Transceiver-to-Transceiver cloning using a microSD card.....	17-17
◇ Cloning from a PC using a microSD card....	17-20
◇ Cloning from a PC using an optional data cable.....	17-20
◇ Transceiver-to-Transceiver cloning using a cable.....	17-21
■ CI-V information.....	17-22
◇ CI-V data setting.....	17-22
◇ CI-V connection example.....	17-22
◇ Data format.....	17-22
◇ Command table.....	17-23

## ■ Voice TX function

The Voice TX function transmits the recorded audio on a microSD card once, or repeatedly, for up to 10 minutes at the specified interval.

### ✓ Convenient!

When the key function [Voice TX] is assigned to the key on the optional HM-75LS SPEAKER-MICROPHONE, the voice audio recorded onto the microSD can be transmitted when the key is pushed.

**NOTE:** Be sure to insert a microSD card to the [micro SD] slot of the transceiver before starting to record a voice audio.

### ◇ Recording

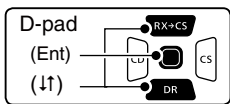

- ① Push [MENU] .
- ② Push D-pad(↑) to select the root item ("Voice TX"), and then push D-pad(Ent).



- ③ Push D-pad(↓) to select "Record," and then push D-pad(Ent).
- ④ Push [PTT] to start recording.
  - After releasing [PTT], the recording is cancelled.
  - Maximum record period is 1 minute.
  - Hold the microphone 5 to 10 cm (2 to 4 inches) from your mouth, then speak at a normal voice level.
  - Only one announcement can be recorded. The current contents will be overwritten if you record again.
- ⑤ Push [MENU]  to exit the MENU screen.

### ◇ The recorded voice audio playing back

The recorded voice audio for the Voice TX function can be played back.

- ① Push [MENU] .
- ② Push D-pad(↑) to select the root item ("Voice TX"), and then push D-pad(Ent).
- ③ Push D-pad(↓) to select "Record," and then push D-pad(Ent).
- ④ Push D-pad(Ent) to start the playback.
- ⑤ Push [MENU]  to exit the MENU screen.

### When no microSD card is inserted:

When no microSD card is inserted, this error message is displayed.

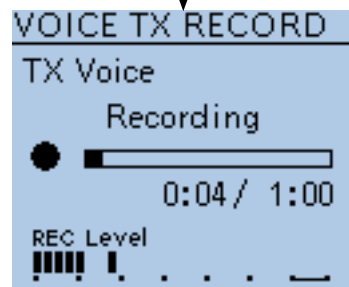
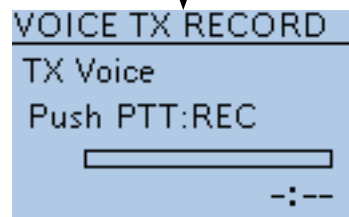
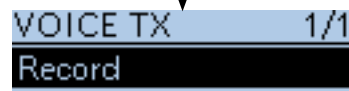
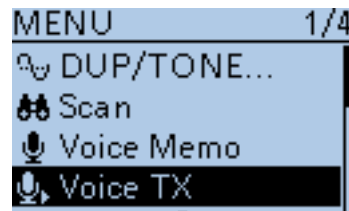
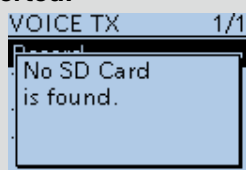

← While recording

← Audio level is displayed

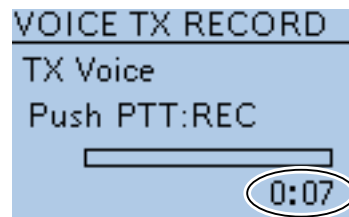

← Recording time is displayed

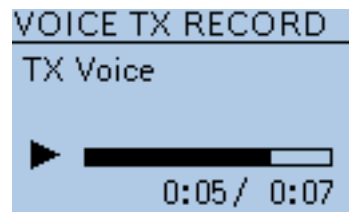

← While playing back

### ✓ Information

You can delete the recorded audio.

- On the DV AUTO REPLY screen, push [QUICK] , and then push D-pad(Ent).

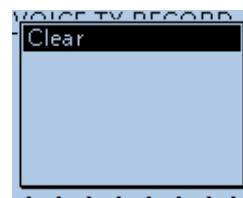

■ Voice TX function (Continued)

◆ To transmit the recorded voice audio

- ① Push [MENU] .
- ② Push D-pad(↑) to select the root item (“Voice TX”), and then push D-pad(Ent).

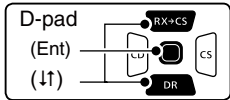

- ③ Push D-pad(↓) to select “<<Single TX>>” or “<<Repeat TX>>,” and then push D-pad(Ent).

**<<Single TX>>**

The transceiver transmits the recorded voice audio once.

**<<Repeat TX>>**

The transceiver repeatedly transmits the recorded voice audio for up to 10 minutes at the interval specified in “Repeat Time.”

- The recorded voice audio is repeatedly transmitted for up to 10 minutes. Even if 10 minutes pass while transmitting, the voice audio is completely transmitted.
  - One of the following steps will cancel the transmission.
    - Push [PTT].
    - Turn OFF the power, then turn it ON again.
    - Push any key (except for [POWER]).
    - Rotate [DIAL].
  - Once the Repeat TX is made, the transceiver pauses until the end of the “Repeat Time,” then transmits again. After the second transmission, the Repeat TX continues pausing, if receiving a signal, even if the Busy Lockout is ON.
- But if the squelch is manually opened in the FM mode, the voice audio is repeatedly transmitted, according to the repeat time setting.

- ④ Push [MENU]  to exit the MENU screen.

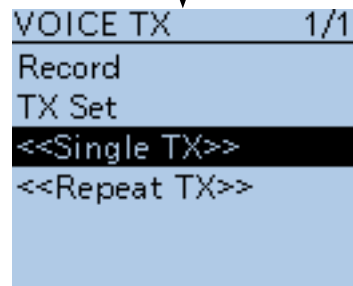
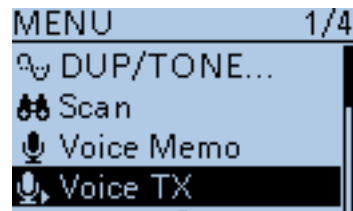

Blinks while transmitting.

• Voice TX Waiting screen for <<Repeat TX>>

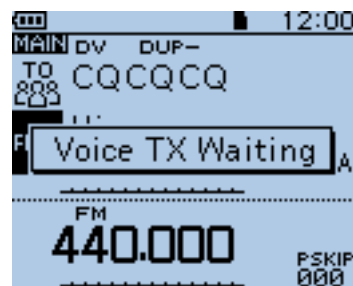

The Voice TX can be selected on the QUICK Menu screen.

- ➔ Push [QUICK] , and then push D-pad(↓) to select “Voice TX.”

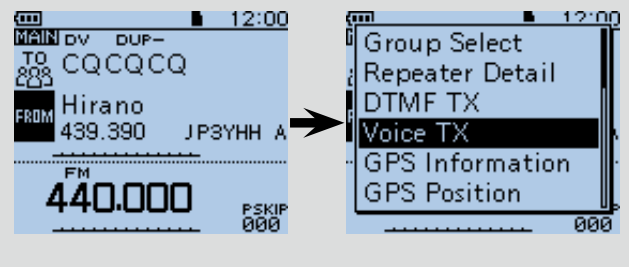

■ Voice TX function (Continued)

◇ Repeat Time setting

Set the repeat interval to between 1 and 15 seconds (in 1 second steps) for the voice repeat transmission.

The transceiver repeatedly transmits the recorded voice audio at this interval.

- ① Push [MENU] .
- ② Push D-pad(↓) to select the root item (Voice TX), and then push D-pad(Ent) to go to the next screen.

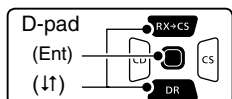

(MENU > Voice TX > TX Set> **Repeat Time**)

- ③ Refer to the menu sequence shown directly above and push D-pad(↓) to select, and then D-pad(Ent) to enter, one or more times until the last screen is displayed.
- ④ Push D-pad(↓) to select the repeat interval to be between 1 and 15 seconds (in 1 second steps).
- ⑤ Push [MENU]  to exit the MENU screen.

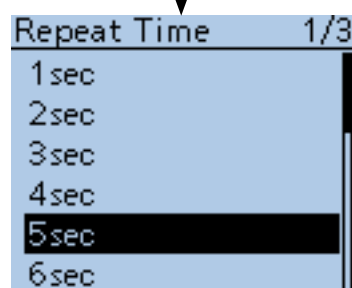
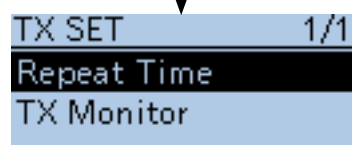
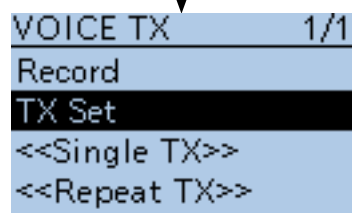
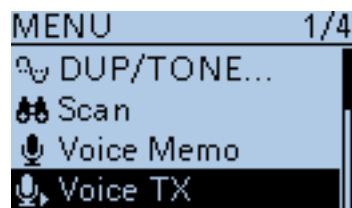

◇ TX Monitor function

Turn the TX Monitor function ON or OFF. (Default: ON)

- ① Push [MENU] .
- ② Push D-pad(↓) to select the root item (Voice TX), and then push D-pad(Ent) to go to the next screen.

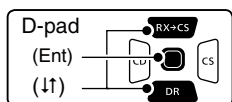

(MENU > Voice TX > TX Set> **TX Monitor**)

- ③ Refer to the menu sequence shown directly above and push D-pad(↓) to select, and then D-pad(Ent) to enter, one or more times until the last screen is displayed.
- ④ Push D-pad(↓) to turn the TX Monitor function ON or OFF.
  - OFF: The TX voice audio is not output from the speaker.
  - ON : The TX voice audio is output from the speaker.
- ⑤ Push [MENU]  to exit the MENU screen.

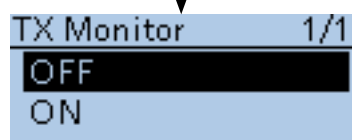
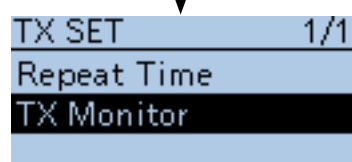
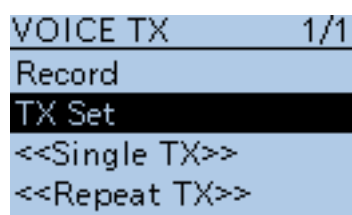

## ■ Home CH Beep function

When the specified Home CH is selected by rotating [DIAL], a beep sounds.

The Home CH is set in each of the VFO mode, Memory mode and DR mode of the transceiver.

You will know the Home CH selection without looking at the display.

### ◇ Home CH setting

- ① Select a frequency to be set as the Home CH.
  - While in the DR mode, select "FROM."
- ② Push [QUICK]<sup>[QUICK]</sup><sub>[SPCH]</sub>.
- ③ Push D-pad(↑) to select "Home CH Set," and then push D-pad(Ent).
- ④ Push D-pad(↑) to select "Set Frequency," and then push D-pad(Ent) to set the Home CH, and exit the QUICK Menu.
  - While in the DR mode, select "Set Repeater," or while in the Memory mode, select "Set Channel."

### ◇ Home CH operation

After setting the Home CH, rotate [DIAL] in the specified mode.

When the Home CH is selected, a beep sounds.

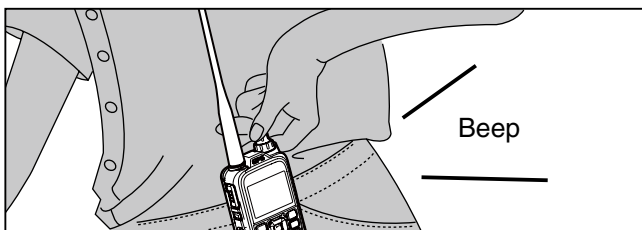

### ✓ Convenient!

When the key function [Home CH] is assigned to the key on the optional HM-75LS SPEAKER-MICROPHONE, the specified Home CH can be selected when the key is pushed.

### ✓ Information

You can clear the Home CH setting.

- ➔ Push D-pad(↑) to select "Clear" in the step ④ as described above, and then push D-pad(Ent)

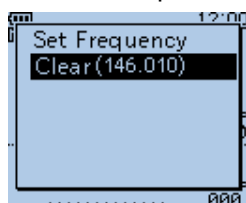

Example: Set "146.010 MHz" frequency in the VFO as the Home CH.

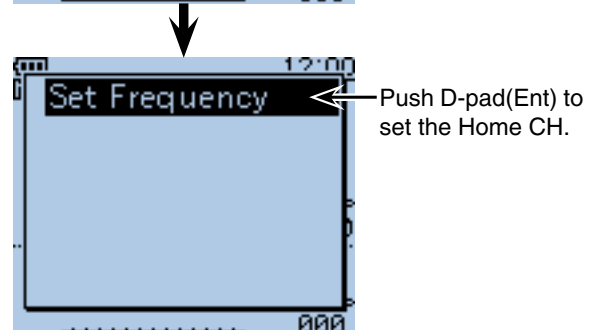
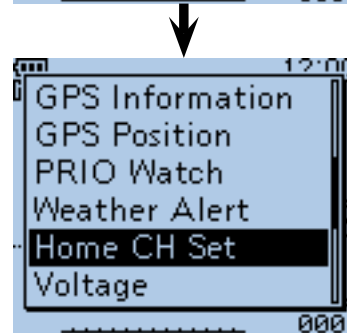
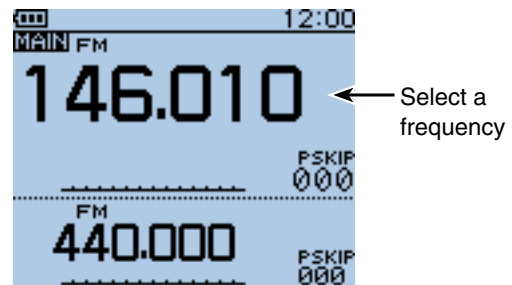

## Speech function

The Speech function audibly announces the displayed frequency and operating mode in the VFO, Memory or Call channel modes, or call sign in the DR mode, when holding down [SPCH]<sup>[QUICK SPCH]</sup>.

Also, other speech functions, [DIAL] speech function and Mode speech function can be used.

**NOTE:** When a call is received during an announcement in the DV mode, the received audio will be muted, and no audio is recorded onto the microSD card. Except in the DV mode, the received audio will be recorded, even during an announcement.

### ◇ [DIAL] speech function setting

The Dial Speech function enables the transceiver to announce the frequency or **repeater** call sign that is selected by rotating [DIAL].

- ① Push [MENU]<sup>[MENU]</sup>.
- ② Push D-pad(↑) to select the root item (“SPEECH”), and then push D-pad(Ent).

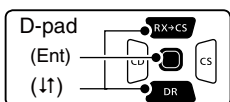

- ③ Push D-pad(↑) to select “DIAL SPEECH,” and then push D-pad(Ent).
- ④ Push D-pad(↑) to select “ON,” and then push D-pad(Ent).
- ⑤ Push [MENU]<sup>[MENU]</sup> to exit the MENU screen.

**NOTE:** If a call is received during an announcement, the announcement is cancelled, and the received audio is heard.

#### The detail settings for the Speech functions

You can set the details settings for the Speech functions in the Menu screen.

- **SPEECH Language** (p. 16-60)  
Set the speech language to English or Japanese.  
(MENU > SPEECH > **SPEECH Language**)
- **Alphabet** (p. 16-60)  
Select either “Normal” or “Phonetic Code” to announce the alphabet character.  
(MENU > SPEECH > **Alphabet**)
- **SPEECH Speed** (p. 16-60)  
Set the speech speed to Low (slow) or High (fast).  
(MENU > SPEECH > **SPEECH Speed**)
- **SPEECH Level** (p. 16-60)  
Enter a volume level number between 0 (minimum) and 9 (maximum) for the voice synthesizer.  
(MENU > SPEECH > **SPEECH Level**)

Example: When “Dallas” (K5TIT B) is selected in “FROM,” hold down [SPCH]<sup>[QUICK SPCH]</sup>

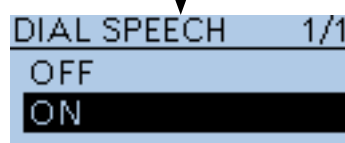
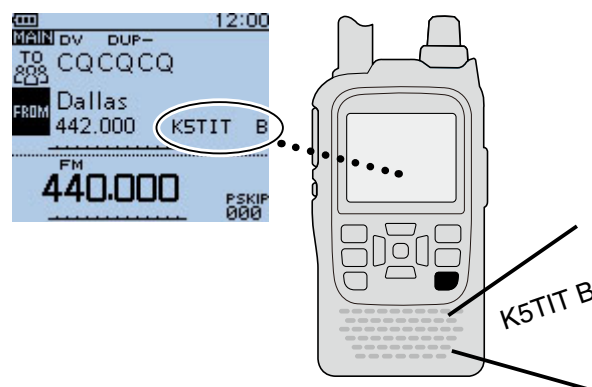

When rotating [DIAL] after setting the Dial Speech function.

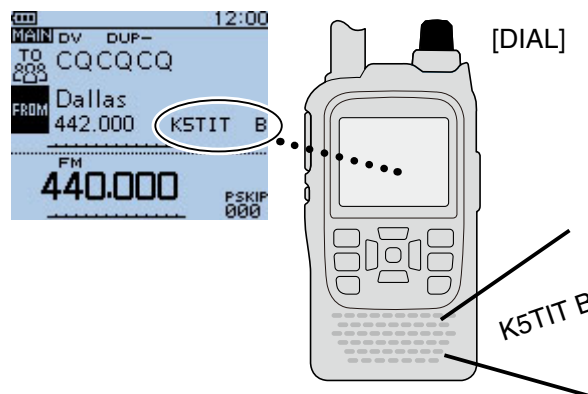



■ Speech function (Continued)

◇ Mode speech function setting

The Mode Speech function enables the transceiver to announce the selected operating mode when the mode switch is pushed.

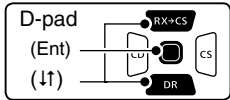
- ① Push [MENU] .
- ② Push D-pad(↑) to select the root item ("SPEECH"), and then push D-pad(Ent).



- ③ Push D-pad(↑) to select "MODE SPEECH," and then push D-pad(Ent).
- ④ Push D-pad(↑) to select "ON," and then push D-pad(Ent).
- ⑤ Push [MENU]  to exit the MENU screen.

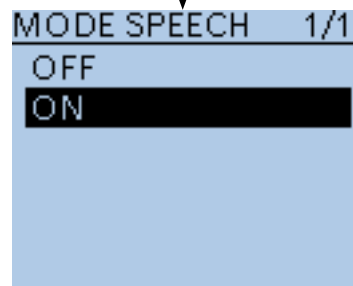
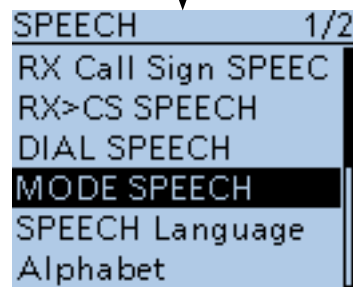

When pushing [MODE]  after setting the Mode Speech function.

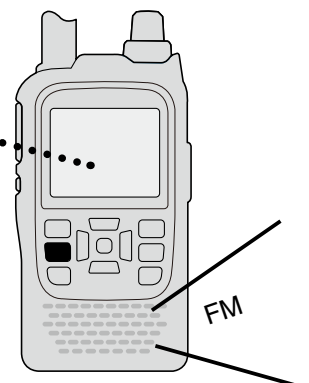
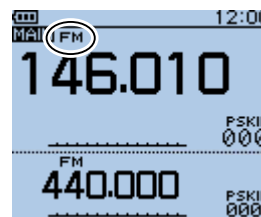

## Using the DTMF memory

The transceiver can store up to 16 channels of **DTMF** memory with 24-digit DTMF code.

### DTMF code programming

- ① Push [MENU] to select the MENU list screen.
- ② Push D-pad(↓) to select the root item (“DTMF/T-CALL”), and then push D-pad(Ent).

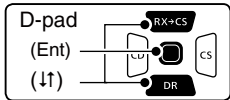

- ③ Push D-pad(↓) to select “DTMF Memory,” and then push D-pad(Ent).
  - DTMF memory channel list (d0 to d#) is displayed.
- ④ Push D-pad(↓) to select the desired DTMF memory channel, then push [QUICK] .
- ⑤ Push D-pad(↑) to select “Edit,” and then push D-pad(Ent) to enter DTMF memory edit mode.
- ⑥ Rotate [DIAL] to select the desired code, the push D-pad(Ent) to set the code.

Repeat the above step to enter the desired DTMF codes.

- Push D-pad(←) to move the cursor backward or forward. When the cursor is on the 24th digit, the cursor can be moved to backward.
  - Push [CLR] to delete the selected character, or hold down [CLR] to continuously delete the characters, first to the right, and then to the left of the cursor.
- ⑦ When all digits are set, push D-pad(Ent).
    - The entered DTMF codes are stored into the DTMF memory channel, and automatically return to DTMF memory screen.
  - ⑧ Push [MENU] to exit the DTMF memory edit mode.

### Information

You can clear the programmed DTMF code.

- ➔ Push D-pad(↓) to select “Clear” in the step ④ as described above, and then push D-pad(Ent)

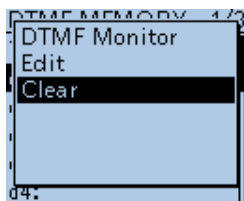

**Example:** Stores the DTMF code, “012345” into the DTMF memory channel “d0.”

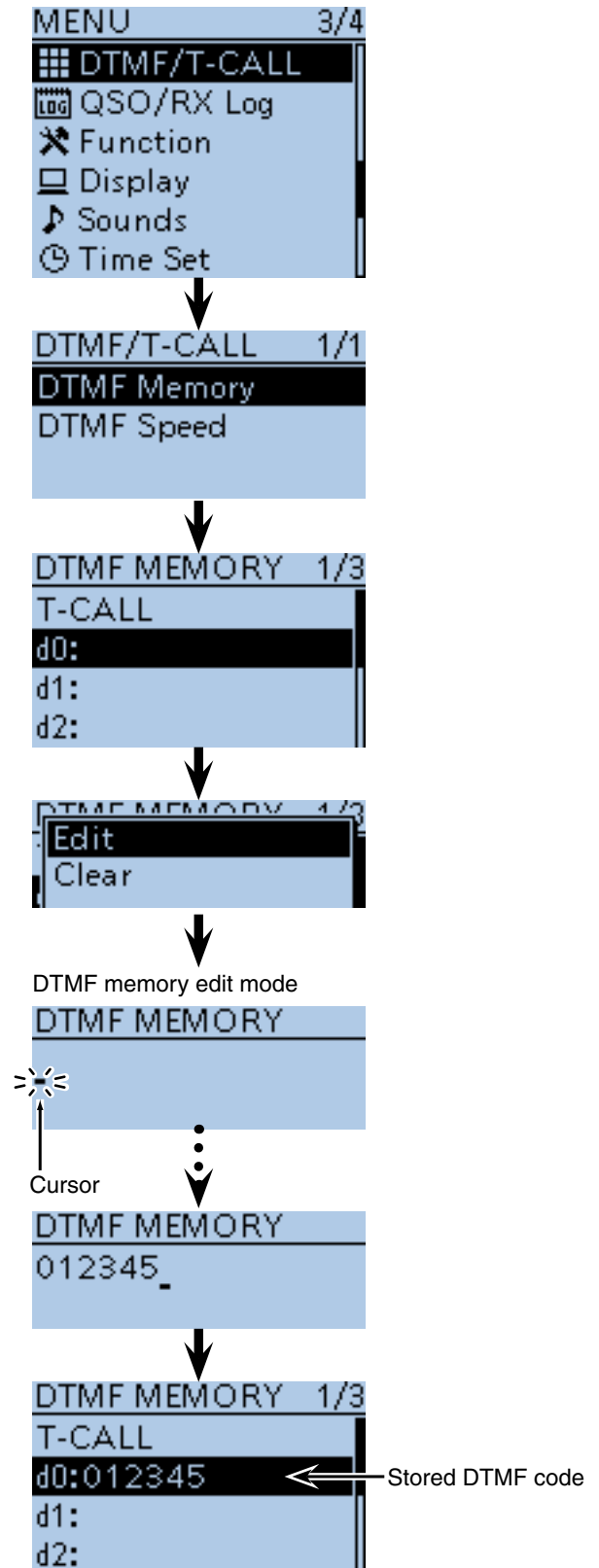



■ Using the DTMF memory

◇ **Monitoring the stored DTMF code**

Select the desired DTMF memory channel to be monitored in DTMF memory screen, then push [SQL].

The stored DTMF code sounds.

- DTMF code can also be monitored with the following steps; Select the desired DTMF memory channel to be monitored, then push [QUICK]<sup>QUICK</sup>[SPCH]. Push D-pad(↑) to select “DTMF Monitor,” and then push D-pad(Ent) to monitor the selected DTMF code.

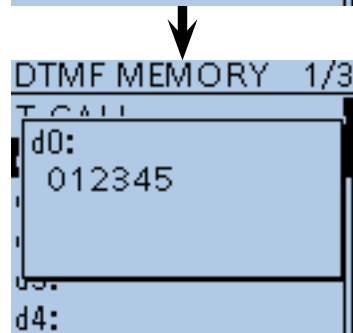
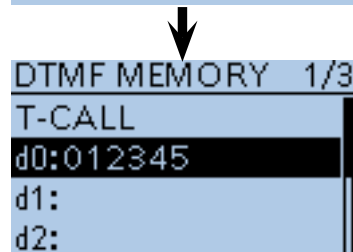
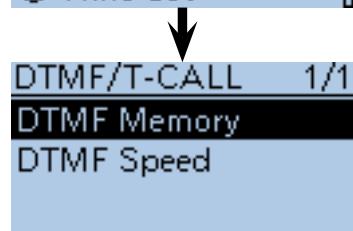
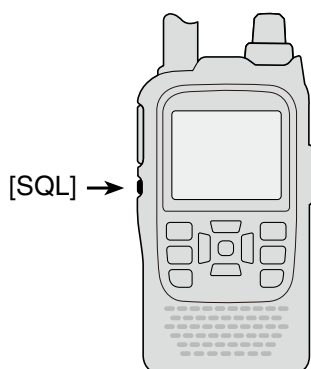



DTMF code sounds

■ Using the DTMF memory (Continued)

◆ DTMF code transmission

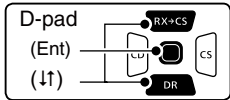
- ① Push [MENU]  to select the MENU list screen.
- ② Push D-pad(↑) to select the root item (“DTMF/T-CALL”), and then push D-pad(Ent).



- ③ Push D-pad(↑) to select “DTMF Memory,” and then push D-pad(Ent).
  - DTMF memory channel list (d0 to d#) is displayed.
- ④ Push D-pad(↑) to select the desired **DTMF** memory channel, then push D-pad(Ent).
  - Beeps sound, and the selected DTMF channel is set for transmission.
- ⑤ Push [MENU]  to exit the MENU screen.
- ⑥ While holding down [PTT], push [SQL] to transmit the selected DTMF code.
  - The transceiver keeps transmission until the all programmed DTMF code is transmitted even [PTT] is released.

**About 1750 Hz tone**

When “T-CALL” is selected in the DTMF MEMORY screen, 1750 Hz tone can be transmitted.

- While holding down [PTT], push [SQL] to transmit 1750 Hz tone is transmitted.
  - The tone is transmitted while holding down [SQL].
- The 1750 Hz tone can be heard from a speaker.

**Example:** Set the DTMF code “012345” stored in DTMF memory channel “d1” for transmission.

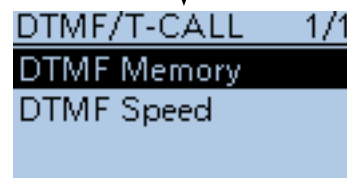
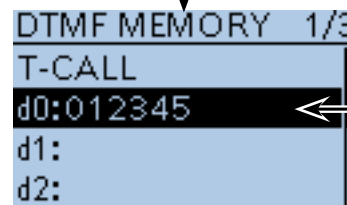
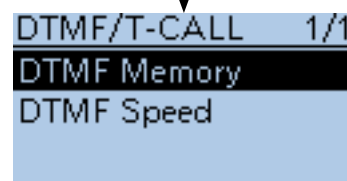

The DTMF code transmission can be made on the QUICK Menu screen.

- ① Push [QUICK] , and then push D-pad(↑) to select “DTMF TX,” and then push D-pad(Ent).
- ② Push D-pad(↑) to select the desired DTMF memory channel, and then push D-pad(Ent).

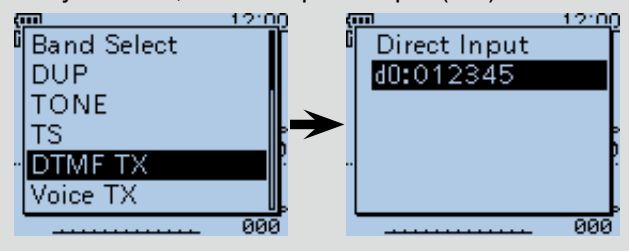

■ Using the DTMF memory (Continued)

◆ DTMF code transmission (Direct Input)

- ① Push [QUICK]<sup>QUICK</sup><sub>SPCH</sub>.
- ② Push D-pad(↵) to select “Direct Input,” and then push D-pad(Ent).
  - DTMF code direct input screen is displayed.

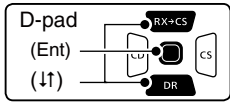

- ③ Rotate [DIAL] to select the desired code, then push D-pad(Ent) to set the code. Repeat the above step to enter the desired DTMF codes.
  - Push D-pad(←) to move the cursor backward or forward. When the cursor is on the 24th digit, the cursor can be moved to backward.
  - Push [CLR]<sup>V/MHz</sup><sub>CLR LOW</sub> to delete the selected character, or hold down [CLR]<sup>V/MHz</sup><sub>CLR LOW</sub> to continuously delete the characters, first to the right, and then to the left of the cursor.
- ④ When all digits are set, push D-pad(Ent).
  - The transceiver automatically transmits the programmed DTMF code.

Example: Directly input the DTMF code “013579AB” for transmission.

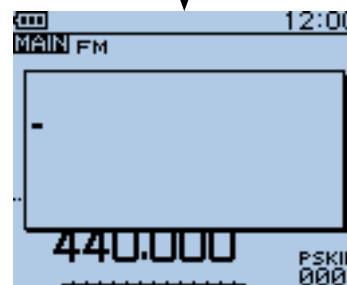
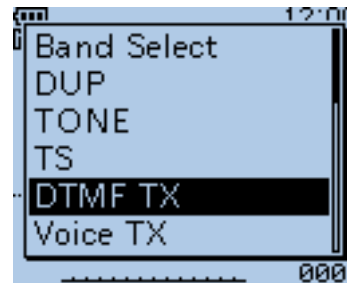

DTMF code direct input screen

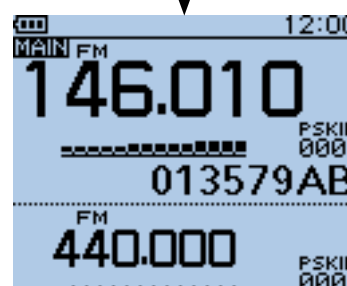
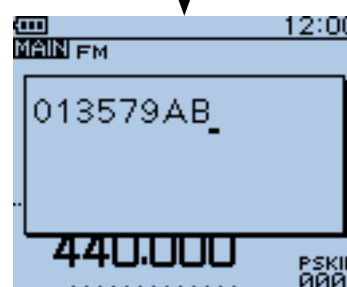

DTMF code scrolls during transmission.

■ Using the DTMF memory (Continued)

◇ **Setting DTMF transfer speed**

The **DTMF** transfer speed can be selected.

- ① Push [MENU]  to select the MENU list screen.
- ② Push D-pad(↑) to select the root item (“DTMF/T-CALL”), and then push D-pad(Ent).

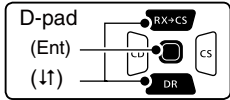

- ③ Push D-pad(↑) to select “DTMF Speed,” and then push D-pad(Ent).
- ④ Push D-pad(↑) to select a desired transfer speed, then push D-pad(Ent)
  - 100ms : Transfer the DTMF tones at about 100 milliseconds per code.  
5 characters per second.
  - 200ms : Transfer the DTMF tones at about 200 milliseconds per code.  
2.5 characters per second.
  - 300ms : Transfer the DTMF tones at about 300 milliseconds per code.  
1.6 characters per second.
  - 500ms : Transfer the DTMF tones at about 500 milliseconds per code.  
1 character per second.
- ⑤ Push [MENU]  to exit the MENU screen.

**Example:** Set the DTMF transfer speed to 300 milliseconds.

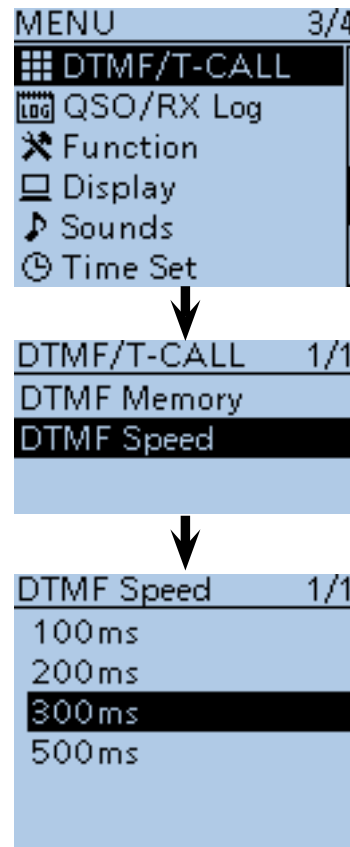

When “100ms” is selected, the DTMF transfer speed is fast.

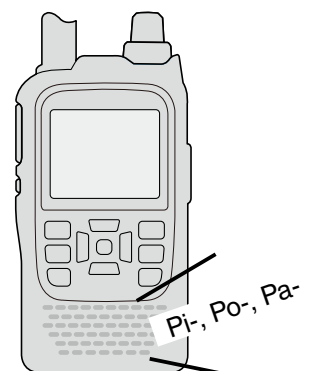



When “500ms” is selected, the DTMF transfer speed is slow.

## ■ Tone squelch operation

The tone **squelch** opens only when you receive a signal containing a matching subaudible tone during FM or FM narrow mode. You can silently wait for calls from others using the same tone.

Also, reversed tone squelch function is ready to mutes the squelch when a signal containing a matched sub-audible tone.

### ◆ Tone squelch frequency setting and operation

- ① Push [V/MHz]  once or more times to select the VFO mode.
- ② Push [MODE]  once or more times to select FM or FM-N (FM narrow) mode.
- ③ Rotate [DIAL] to select a desired operating frequency.
- ④ Push [MENU]  to select the MENU list screen.
- ⑤ Push D-pad(↑) to select the root item (“DUP/TONE...”), and then push D-pad(Ent).

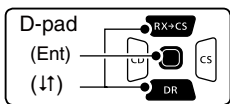

- ⑥ Push D-pad(↓) to select “TSQL Freq,” and then push D-pad(Ent).
  - The selected tone squelch frequency is displayed.
- ⑦ Rotate [DIAL] to select a desired tone squelch frequency, then push D-pad(Ent).
  - (Example: 100.0 Hz)
  - Select a tone squelch frequency within 67.0 to 254.1 Hz.

#### ✓ Information

To return to the default tone squelch frequency, push [QUICK]  in the step ⑥ as described above, and then push D-pad(Ent)

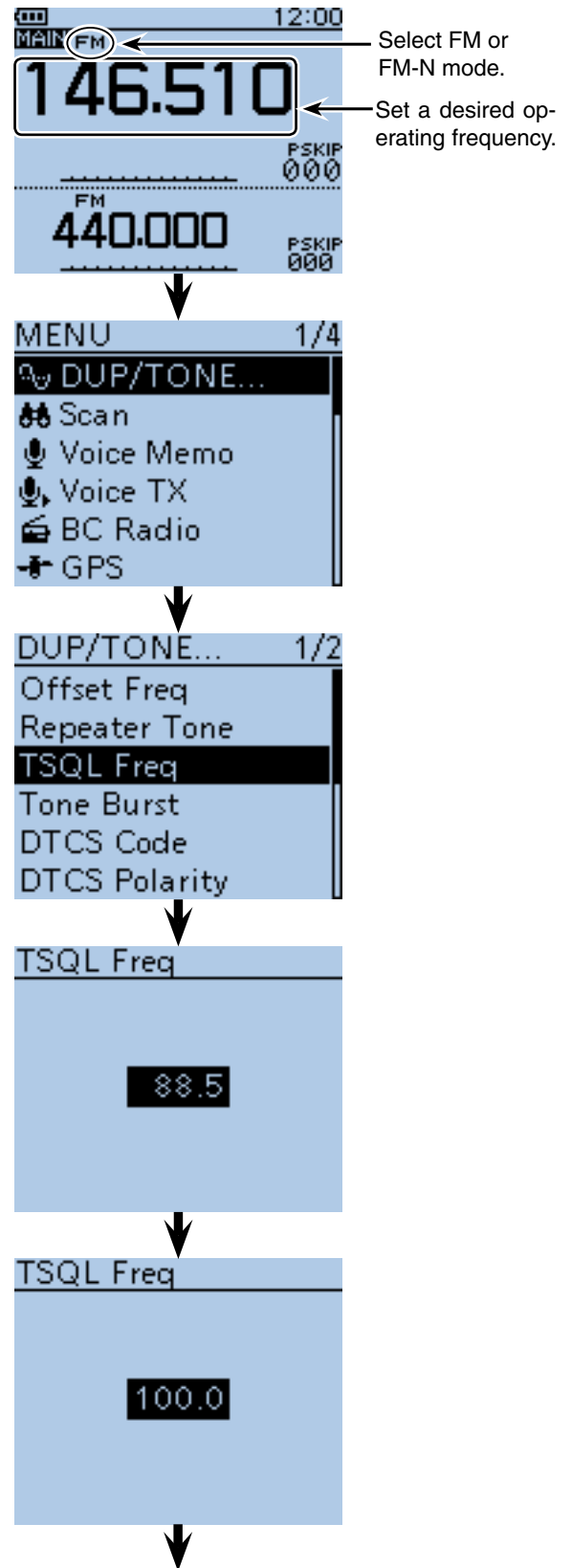
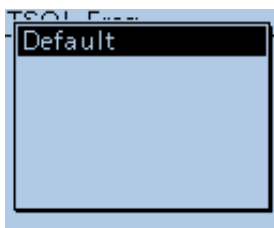



Continued to the step ⑧ on the next page

# 17 OTHER FUNCTIONS

## ■ Tone squelch operation

### ◇ Tone squelch frequency setting and operation (Continued)

- ⑧ Push [MENU]  to exit the MENU screen.
- ⑨ Push [QUICK] .
- ⑩ Push D-pad(↑) to select "TONE," and then push D-pad(Ent).

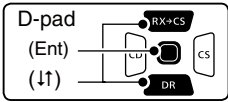

- ⑪ Push D-pad(↑) to select either "TSQL((·))" or "TSQL."
  - TSQL((·)) : The tone **squelch** with pocket beep function ON.
  - TSQL : The tone squelch function ON.
  - When stands by the reversed tone squelch function, select "TSQL-R."
- ⑫ Push D-pad(Ent) to set the tone squelch function, and then close the QUICK Menu screen.
- ⑬ Holding down [PTT] and call a desired station. Operate as the normal way.

### **For your information: Sounds beep when a call is received.**

If "TSQL((·))" is selected in step ⑪, beeps sound for 30 seconds and the icon "((·))" blinks when a call with the matched tone signal is received.

➔ After receiving a call, hold down [PTT] within 30 seconds then start conversation, or push D-pad(Ent) to cancel the pocket beep function ("((·))" icon disappears). After that, the transceiver selects regular tone squelch operation.

- When receiving a call with "TSQL((·))"



Beep, Beep, Beep...

Continued from step ⑦ on the previous page.

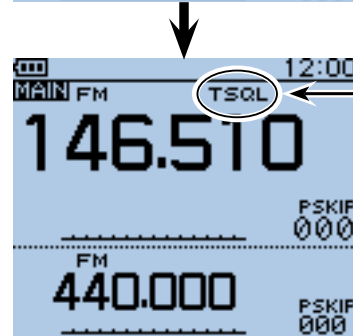
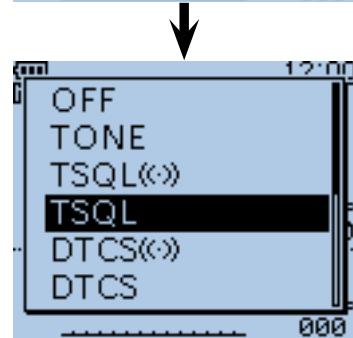
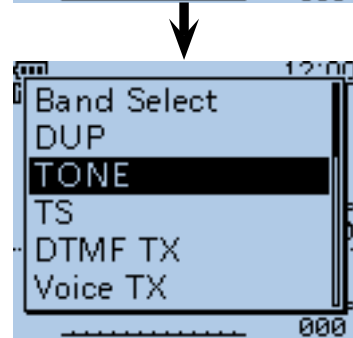
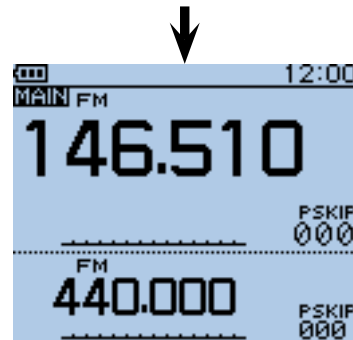

- Appears.
- When reversed tone squelch is selected in step ⑪, "TSQL-R" icon appears.

## ■ DTCS squelch operation

The tone **squelch** opens only when you receive a signal containing a matching DTCS code during FM or FM narrow mode. You can silently wait for calls from others using the same tone.

Also, reversed tone squelch function is ready to mutes the squelch when a signal containing a matched DTCS code.

### ◇ DTCS code setting and operation

- ① Push [V/MHz] once or more times to select the VFO mode.
- ② Push [MODE] once or more times to select FM or FM-N (FM narrow) mode.
- ③ Rotate [DIAL] to select a desired operating frequency.
- ④ Push [MENU] to select the MENU list screen.
- ⑤ Push D-pad(↑) to select the root item (“DUP/TONE...”), and then push D-pad(Ent).

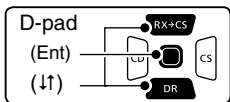

- ⑥ Push D-pad(↑) to select “DTCS Code,” and then push D-pad(Ent).
  - The selected tone squelch frequency is displayed.
- ⑦ Rotate [DIAL] to select a desired DTCS code, and then push D-pad(Ent).
  - (Example: 125)
  - Select a DTCS code within 023 to 754.

#### ✓ Information

To return to the default code, push [QUICK] in the step ⑥ as described above, and then push D-pad(Ent)

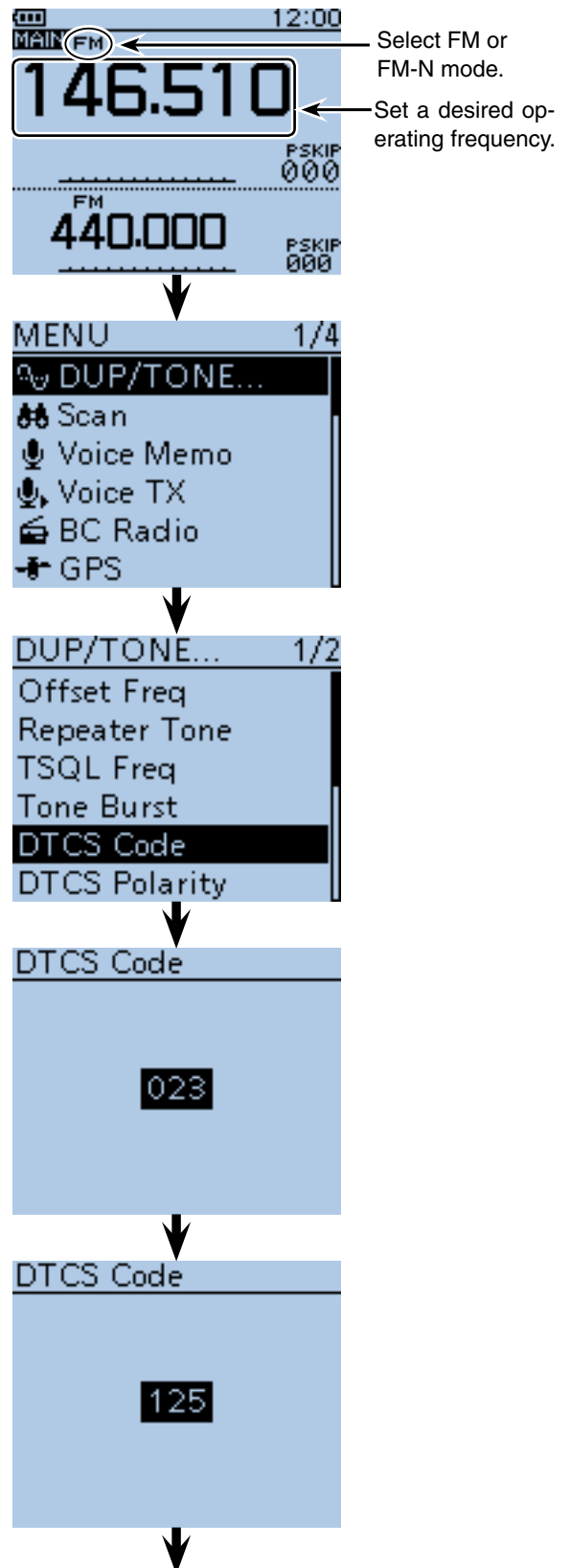
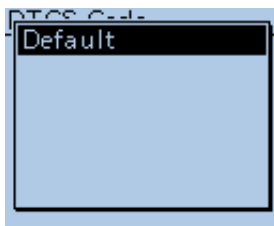



Continued to the step ⑧ on the next page

# 17 OTHER FUNCTIONS

## ■ Tone squelch operation

### ◇ DTCS code setting and operation (Continued)

- ⑧ Push [MENU]  to exit the MENU screen.
- ⑨ Push [QUICK] .
- ⑩ Push D-pad(↑) to select "TONE," and then push D-pad(Ent).

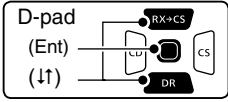

- ⑪ Push D-pad(↑) to select either "DTCS((·))" or "DTCS" option.
  - DTCS((·)) : The DTCS **squelch** with pocket beep function ON.
  - DTCS : The DTCS squelch function ON.
  - When stands by the reversed tone squelch function, select "DTCS-R."
- ⑫ Push D-pad(Ent) to set the DTCS squelch function, and then close the QUICK Menu screen.
- ⑬ Holding down [PTT] and call a desired station. Operate as the normal way.

### **For your information: Sounds beep when a call is received.**

If "DTCS((·))" is selected in step ⑪, beeps sound for 30 seconds and the icon "((·))" blinks when a call with the matched DTCS code signal is received.

➔ After receiving a call, hold down [PTT] within 30 seconds then start conversation, or push D-pad(Ent) to cancel the pocket beep function ("((·))" icon disappears). After that, the transceiver selects regular DTCS squelch operation.

If no operation is performed within 30 seconds, beeps stop sounding and the "((·))" icon blinking remained.

- When receiving a call with "DTCS((·))"



Continued from step ⑦ on the previous page.

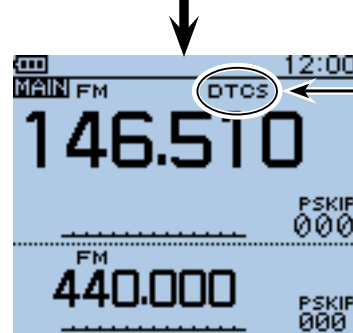
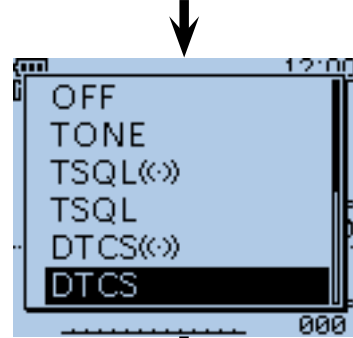
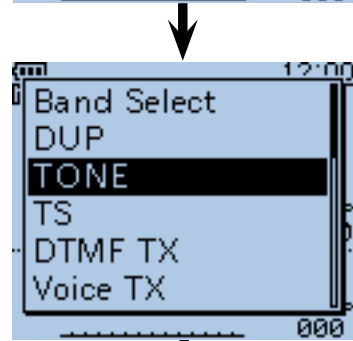
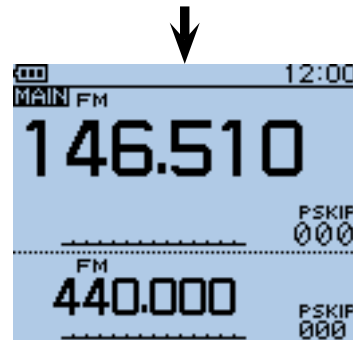

- Appears.
- When reversed tone squelch is selected in step ⑪, "DTCS-R" icon appears.



## ■ Cloning function

The ID-51A/E has data cloning capability. This function is useful when you want to copy all of the programmed contents from one ID-51A/E to another. And PC cloning is also possible.

- **Transceiver-to-Transceiver cloning using a microSD card** (described on this page)

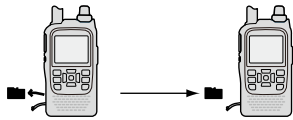

- **Transceiver-to-Transceiver cloning using a cable** (see page 17-21)



- **Cloning from a PC using a microSD card** (see page 17-20)

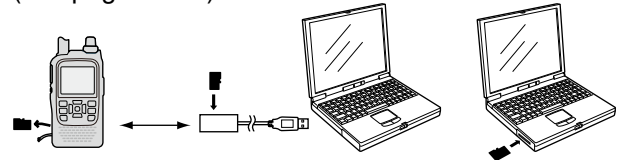

- **Cloning from a PC using an optional data cable** (see page 17-20)

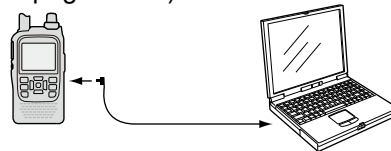

### ◇ Transceiver-to-Transceiver cloning using a microSD card

In this caption, describes cloning method using the microSD card. Memory channel contents, MENU item settings and **repeater** list can be stored onto a microSD card.

Recorded voice memories are not included in the cloning data. To play back the master transceiver's voice memory, attach the microSD card to sub transceiver, or make a copy onto the sub transceiver's microSD card using a PC.

\*Describes the case of the microSD card has already been attached.

#### 1. Saving the master transceiver's setting data onto the microSD card.

- ① Push [MENU] (MENU).
- ② Push D-pad(↑) to select the root item ("SD card"), and then push D-pad(Ent).

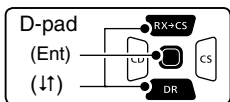

- ③ Push D-pad(↑) to select "Save Setting," and then push D-pad(Ent).
- ④ Push D-pad(↑) to select "<<New File>>," and then push D-pad(Ent).
  - The FILE NAME screen is displayed.
- ⑤ The file name is automatically named in the following manner;
  - "Setyyyyymmdd\_xx" (yyyy:Year, mm:month, dd:day, xx: serial number)
  - Example: When the 2nd file is saved on 3rd December, 2012, the file is named "Set20121203\_02."
  - If you want to change the file name, see "Save with a different file name" (p. 2-7).

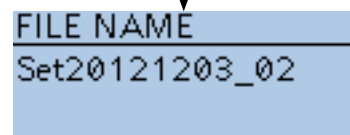
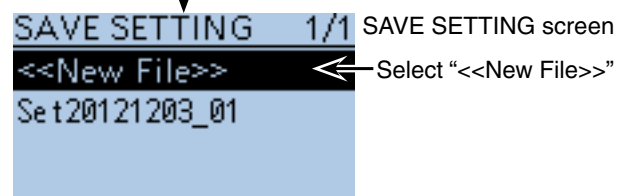
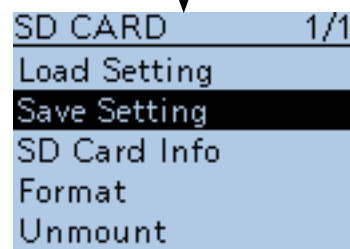
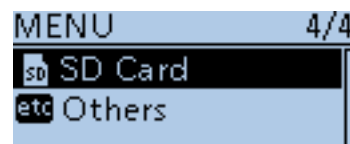

☞ Continued on the next page

■ Cloning function

◇ Transceiver-to-Transceiver cloning using a microSD card (Continued)

⑥ Push D-pad(Ent) to set the file name.

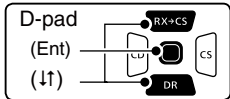

The confirmation screen “Save file?” appears.

⑦ Push D-pad(↑) to select “YES,” and then push D-pad(Ent) to save.

• While saving, a progress bar is displayed, then the “SD CARD” screen is displayed after the save is completed.

⑧ Push [MENU]  to exit the MENU screen.

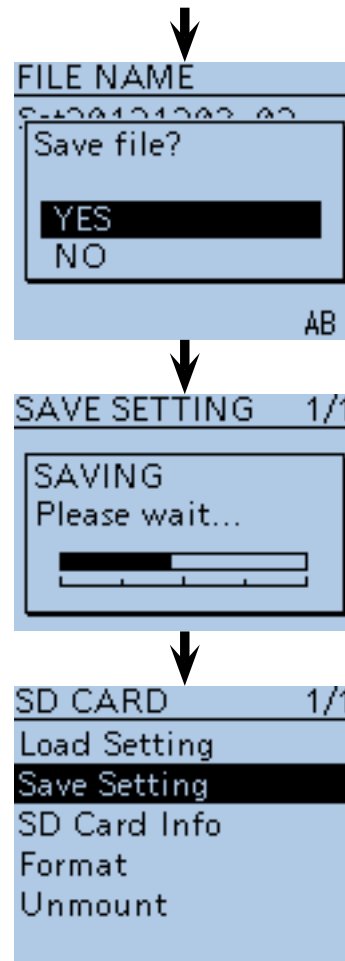

**2. Remove the microSD card from the master transceiver, and then attach it to the sub transceiver.**

⑨ Hold down the master transceiver’s [⏻] to turn OFF the power.

⑩ Remove the microSD card from the master transceiver as shown at right.

⑪ Attach the removed microSD card to the sub transceiver, then hold down the sub transceiver’s [⏻] to turn ON the power.

⚡ **NEVER** forcibly or inversely insert the card.  
 ⚡ It will damage the card and/or the slot.

• Removing the microSD card

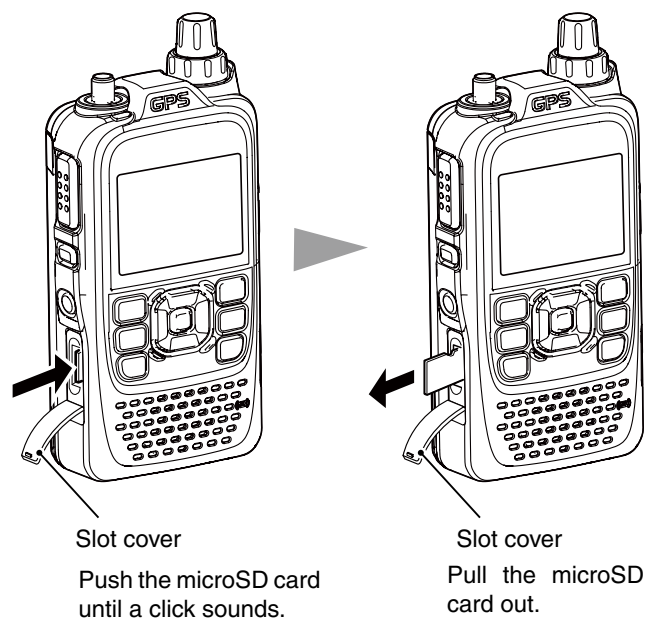

■ Cloning function

- ◇ Transceiver-to-Transceiver cloning using a microSD card (Continued)

**3. Loads the setting data into the sub transceiver.**

- ⑫ Push [MENU] .
- ⑬ Push D-pad(↑) to select the root item (“SD card”), and then push D-pad(Ent).

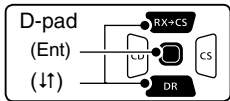

- ⑭ Push D-pad(↑) to select “Load Setting,” and then push D-pad(Ent).
- ⑮ Push D-pad(↑) to select the desired setting file, and then push D-pad(Ent).
- ⑯ Push D-pad(↑) to select the desired loading content, as shown below.

- **ALL:** Loads all memory channels, item settings in the menu list and the **repeater** list into the transceiver.
- **Except My Station:** Loads all memory channels, item settings in the menu list except MY call signs and the repeater list into the transceiver.
- **Repeater List Only:** Loads only the repeater list into the transceiver.

- ⑰ Push D-pad(Ent).
  - The “Keep ‘SKIP’ setting in Repeater List?” appears.
- ⑱ Push D-pad(↑) to select “YES” or “No.”
  - When “Yes” is selected, the skip setting of the repeater list is retained. (p. 9-36)
- ⑲ Push D-pad(Ent).
  - “Load file?” appears.
- ⑳ Push D-pad(↑) to select “Yes,” and then push D-pad(Ent) to start the file check.
  - While checking the file, “FILE CHECKING” and a progress bar are displayed.
- ㉑ After checking, settings data loading starts.
  - While loading, “LOADING” and a progress bar are displayed.
- ㉒ After loading, “COMPLETED!” appears. To complete the loaded, reboot the transceiver.

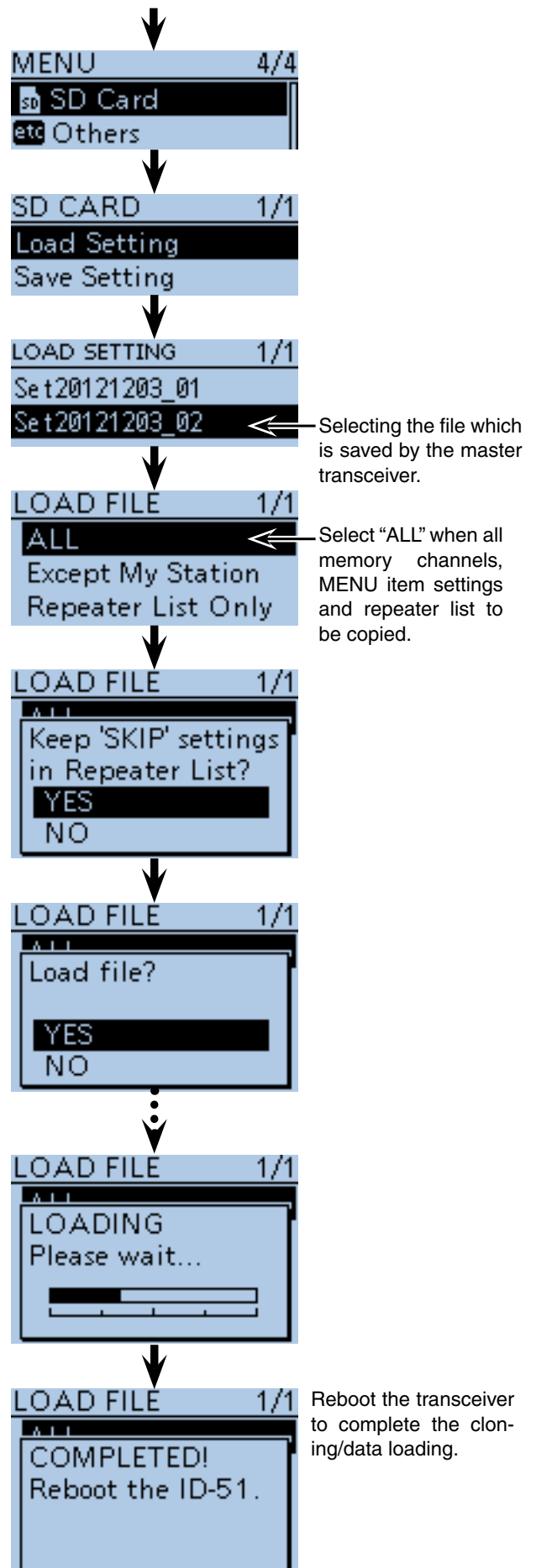

■ Cloning function (Continued)

◇ Cloning from a PC using a microSD card

The cloning can be performed from a PC using a microSD card.

Set a desired memory channels, MENU item settings and **repeater** list by the CS-51 cloning software (contained in the CD), and save them in an "icf" file format. Copy the "icf" file into the "Setting" folder in the "ID-51" folder of the microSD card.

• microSD card configuration

Attach the microSD card that includes the "icf" file, then load it to complete the cloning.

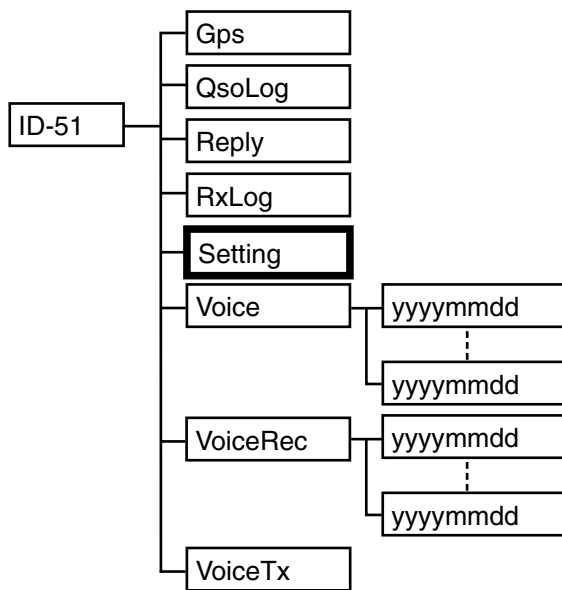

• Connections

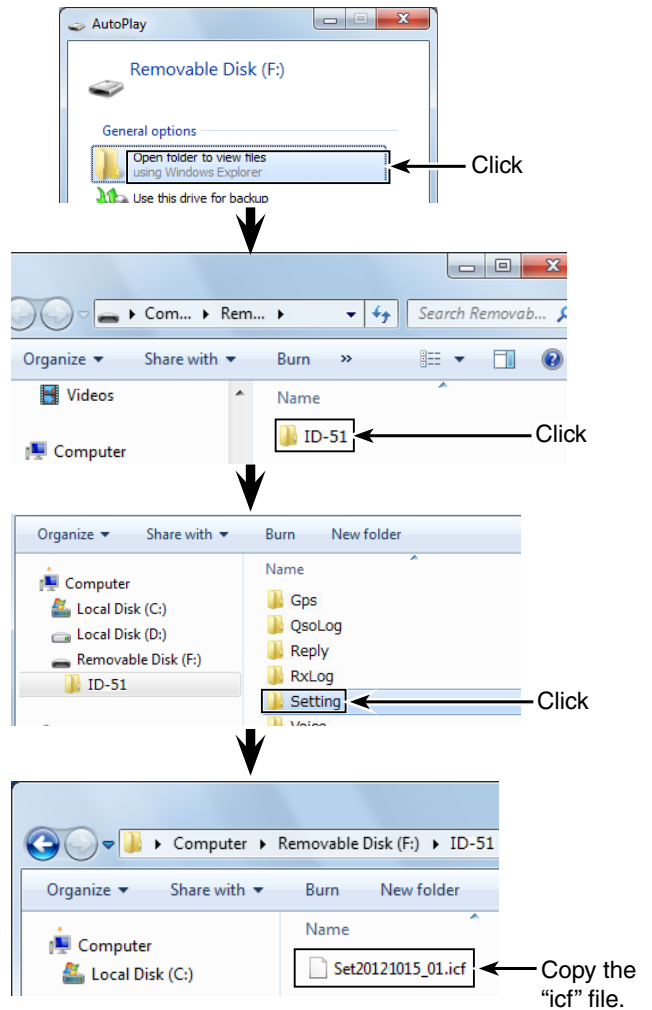
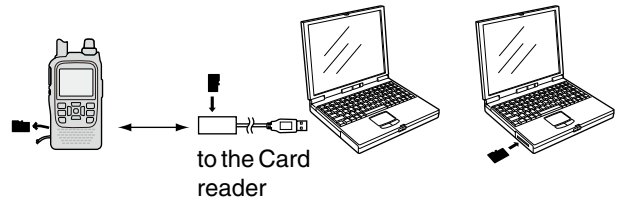

◇ Cloning from a PC using an optional data cable

Cloning can be performed using the CS-51 (contained in the CD) and the optional OPC-2218LU.

See the CS-51 instruction manual (contained in the CD) and the OPC-2218LU instruction manual (downloaded from the Icom WEB site; <http://www.icom.co.jp/world/>)

**NOTE: When using the optional OPC-2218LU**  
 Before cloning, select "PTT" option in DV Data TX item.  
 If "Auto" is selected, the transceiver may transmit with the cloning data.  
 (DV Set > DV Data TX)

• Connections

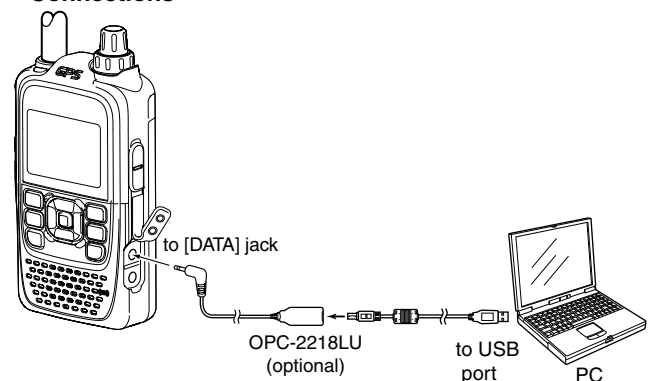

■ Cloning function (Continued)

◇ Transceiver-to-Transceiver cloning using a cable

Connects two ID-51A/E (master and sub transceiver) using a stereo audio cable (purchase locally). Use the stereo audio cable (3.5 (d) mm; 1/8"), purchase locally.

\*According to a stereo audio cable may not be used for cloning.

**1. Transceivers connection**

- ① Hold down [⏻] to turn OFF the both master and sub transceivers.
- ② Connect a stereo audio cable between master and sub transceiver at right.
- ③ Hold down [⏻] to turn ON the both master and sub transceivers.

**2. Setting on the Sub transceiver**

- ④ On the sub transceiver, push [MENU] .
- ⑤ Push D-pad(⏴) to select the root item ("Others"), and then push D-pad(Ent) to go to the next screen.
- ⑥ Push D-pad(⏴) to select "Clone," and then push D-pad(Ent).
- ⑦ Push D-pad(⏴) to select "Clone Mode," and then push D-pad(Ent).
  - The "Go to the Clone Mode?" appears.
- ⑧ Push D-pad(⏴) to select "Yes," and then push D-pad(Ent).
  - The clone mode screen appears.

**3. Setting on the Master transceiver**

- ⑨ On the master transceiver, push [MENU] .
- ⑩ Push D-pad(⏴) to select the root item ("Others"), and then push D-pad(Ent) to go to the next screen.
- ⑪ Push D-pad(⏴) to select "Clone," and then push D-pad(Ent).
- ⑫ Push D-pad(⏴) to select "Clone Master Mode," and then push D-pad(Ent).
  - The "Go to the Clone Master Mode?" appears.
- ⑬ Push D-pad(⏴) to select "Yes," and then push D-pad(Ent).
  - The clone master mode screen appears.
- ⑭ Push [PTT] on the master transceiver.
  - On the sub transceiver, "CLONE-IN" screen appears.
  - On the master transceiver, "CLONE-OUT" screen appears.
- ⑮ When cloning is completed, the master transceiver returns to the clone master mode screen.
  - The sub transceiver displays "CLONE End" screen.
  - If you have another ID-51A/E to clone, replace the sub transceiver and then push [PTT] of the master transceiver.
- ⑯ Reboot the sub transceiver to enable the cloned setting.

• Connections

**Master transceiver**  
(sends a cloning data)

**Sub transceiver**  
(receives a cloning data)

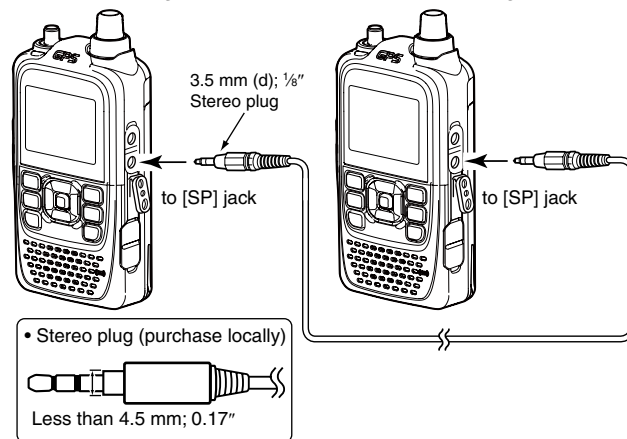

• Screen of the master transceiver

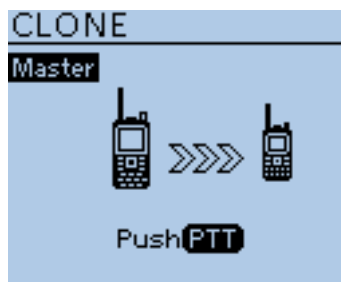

"CLONE" screen

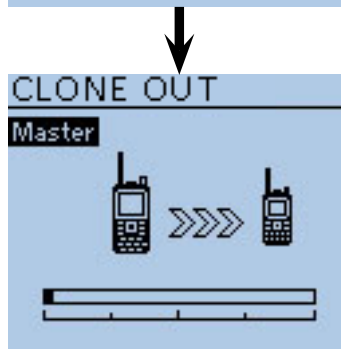

"CLONE-OUT" screen  
(While sending data)

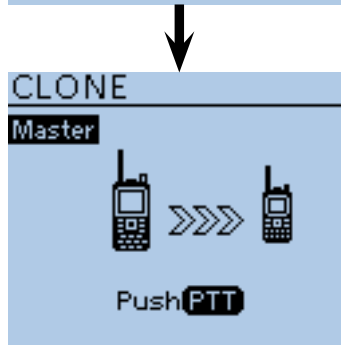

Return to the  
"CLONE" screen

## CI-V information

### CI-V data setting

Set the ID-51A/E's address, data transferring speed and transceive function. See page 16-70 for setting the CI-V condition using the MENU list screen.

Function > CI-V

### CI-V connection example

The transceiver can be connected through an optional CT-17 CI-V LEVEL CONVERTER to a PC equipped with an RS-232C port.

The Icom Communications Interface-V (CI-V) controls the transceiver.

Up to 4 Icom CI-V transceivers or receivers can be connected to the PC.

See the CT-17 instruction manual for details of remotely control a transceiver or receiver.

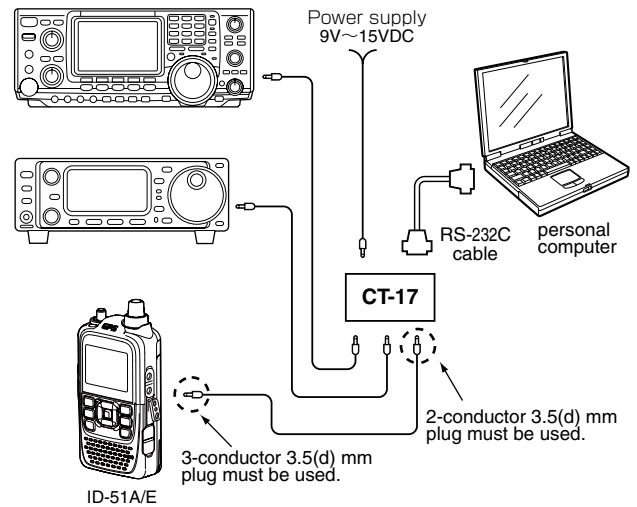

\*Use the cable described at right. No received audio is heard when the supplied control cable, coming with CT-17, is used for the connection.

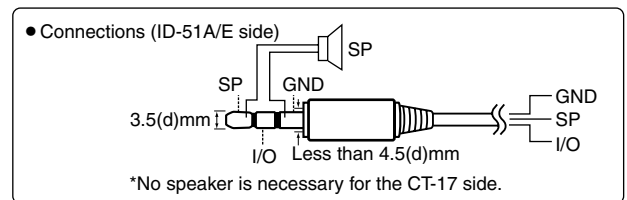

### Data format

The CI-V system can be operated using the following data formats. Data formats differ depending on command numbers. A data area or sub command is added to some commands.

#### Controller to ID-51A/E

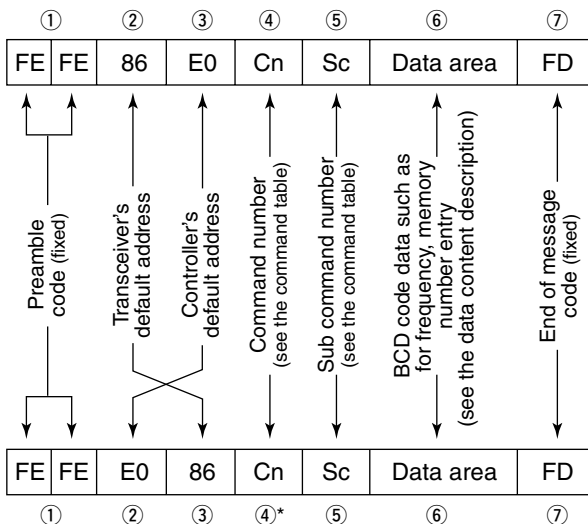

#### ID-51A/E to controller

\*The reply messages from the transceiver are the command "FB" (OK) or "FA" (NG).



# 17 OTHER FUNCTIONS

## ■ CI-V information (Continued)

### ◇ Command table

Cmd.	Sub cmd.	Data	Description
00		see p. 17-24	Send operating frequency for transceive
01		see p. 17-24	Send operating mode for transceive
03		see p. 17-24	Read operating frequency
04		see p. 17-24	Read operating mode
05		see p. 17-24	Send operating frequency
06		see p. 17-24	Send operating mode
07	D0		Select A band Dualwatch: Set the Main band as the A band Single watch: Select the A band
	D1		Select B band Dualwatch: Set the Main band as the B band Single watch: Select the B band
0C		see p. 17-24	Read <b>frequency offset*</b>
0D		see p. 17-24	Send frequency offset
0F			Read <b>duplex</b> setting (10=simplex, 11=DUP-, 12=DUP+)
	10		Set <b>simplex</b> operation
	11		Set DUP- operation
	12		Set DUP+ operation
11		00	Send/read attenuator OFF (AIR band)
		30	Send/read 30 dB attenuator (AIR band)
14	01	see p. 17-24	Send/read audio output level
	03	see p. 17-24	Send/read <b>squelch</b> level
	0A	see p. 17-24	Send/read RF power setting
	0B	see p. 17-24	Send/read external microphone gain.
	16	see p. 17-24	Send/read VOX gain.
15	01	00	Read noise/S-meter squelch status (squelch close)
		01	Read noise/S-meter squelch status (squelch open)
	02	0000 to 0255	Read S-meter level (0000=S0, 0170=S9)
	05	00	Read tone squelch and RF squelch status (squelch close)
		01	Read tone squelch and RF squelch status (squelch open)
	11	0000 to 0255	Read RF power meter (0005=S-LOW, 0026=LOW1, 0051=LOW2, 0128=MID, 0255=HIGH)
16	42	00	Send/read <b>Repeater</b> tone OFF
		01	Send/read Repeater tone ON
	43	00	Send/read Tone squelch OFF
		01	Send/read Tone squelch ON
		02	Send/read Reversed Tone squelch ON
	46	00	Send/read VOX function OFF
		01	Send/read VOX function ON
	4B	00	Send/read DTCS OFF
		01	Send/read DTCS ON
		02	Send/read Reversed DTCS ON
	59	00	Send/read Sub band OFF
		01	Send/read Sub band ON
	5B	00	Send/read DSQL/CSQL OFF (DV mode only)
01		Send/read DSQL ON (DV mode only)	
02		Send/read CSQL ON (DV mode only)	
18	00		Turning the transceiver power OFF
	01		Turning the transceiver power ON*2
19	00		Read transceiver ID.

Cmd.	Sub cmd.	Data	Description	
1B	00	see p. 17-24	Send/read Repeater tone frequency	
	01	see p. 17-24	Send/read Tone squelch frequency	
	02	see p. 17-24	Send/read DTCS code and polarity	
	07	see p. 17-25	Send/read CSQL code (DV mode)	
1C	00	00	Send/read Transceiver's status (RX)	
		01	Send/read Transceiver's status (TX)	
1F	00	see p. 17-25	Send/read DV MY call sign	
	01	see p. 17-25	Send/read DV TX call signs	
	02	see p. 17-25	Send/read DV TX message	
20	00	00*3	Send/read Auto DV RX Call signs output OFF	
		01*3	Send/read Auto DV RX Call signs output ON	
		01	see p. 17-26	Output DV RX Call signs
		02	see p. 17-26	Read DV RX Call signs
	01	00	00*3	Send/read Auto DV RX message output OFF
			01*3	Send/read Auto DV RX message output ON
		01	see p. 17-26	Output DV RX message
		02	see p. 17-26	Read DV RX message
	02	00	00*3	Send/read Auto DV RX status output OFF
			01*3	Send/read Auto DV RX status output ON
		01	see p. 17-25	Output DV RX status
		02	see p. 17-25	Read DV RX status

\*1: Less than 100 Hz is omitted.

\*2: When sending the power ON command (18 01), the command "FE" must be sent before the basic format.

- 19200bps : 50
- 9600bps : 26
- 4800bps : 14
- 1200bps : 5
- 300bps : 3

e.g.: When operating with 4800 bps

		①		②		③		④		⑤		⑦	
F	E	F	E	8	6	E	O	1	8	0	1	F	D

x14

- ① Preamble code (fixed)
- ② Transceiver's default address
- ③ Controller's default address
- ④ Command number
- ⑤ Sub command number
- ⑦ End of message code (fixed)

\*3: Output setting is automatically turned OFF after turning the power OFF, then ON.

■ CI-V information (Continued)

• Receive frequency setting

Command: 00, 03, 05

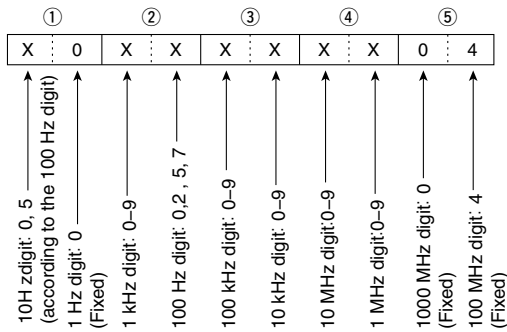

\*10 Hz digit is fixed to "5" when 100 Hz digit is either "2" or "7", and fixed to "0" when 100 Hz digit is other than "2" and "7."

• Operating mode

Command: 01, 04, 06

Operating mode	① Mode		② Filter setting	
	①	②	①	②
FM	05	01		
FM-N	05	02		
DV	17	01		

• Duplex Frequency offset setting

Command: 0C, 0D

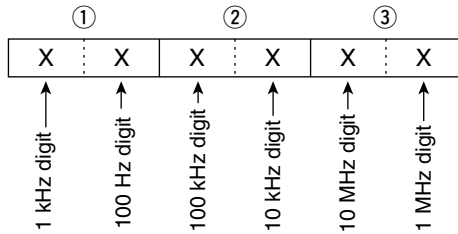

• Audio output level setting

Command: 1401

VOL0	VOL1	VOL2	VOL3	VOL4
0000-0005	0006-0012	0013-0018	0019-0025	0026-0031
VOL5	VOL6	VOL7	VOL8	VOL9
0032-0037	0038-0044	0045-0050	0051-0057	0058-0063
VOL10	VOL11	VOL12	VOL13	VOL14
0064-0069	0070-0076	0077-0082	0083-0089	0090-0095
VOL15	VOL16	VOL17	VOL18	VOL19
0096-0101	0102-0108	0109-0114	0115-0121	0122-0127
VOL20	VOL21	VOL22	VOL23	VOL24
0128-0133	0134-0140	0141-0146	0147-0153	0154-0159
VOL25	VOL26	VOL27	VOL28	VOL29
0160-0165	0166-0172	0173-0178	0179-0185	0186-0191
VOL30	VOL31	VOL32	VOL33	VOL34
0192-0197	0198-0204	0205-0210	0211-0217	0218-0223
VOL35	VOL36	VOL37	VOL38	VOL39
0224-0229	0230-0236	0237-0242	0243-0249	0250-0255

• Squelch level setting

Command: 1403

OPEN	AUTO	LEVEL1	LEVEL2	LEVEL3
0000-0022	0023-0046	0047-0069	0070-0092	0093-0115
LEVEL4	LEVEL5	LEVEL6	LEVEL7	LEVEL8
0116-0139	0140-0162	0163-0185	0186-0208	0209-0232
LEVEL9				
0233-0255				

• RF power level setting

Command: 140A

S-LOW	LOW1	LOW2	MID	HIGH
0000-0050	0051-0101	0102-0153	0154-0204	0205-0255

• External microphone gain setting

Command: 140B

1	2	3	4
0000-0063	0064-0127	0128-0191	0192-0255

• VOX gain setting

Command: 1416

OFF	1	2	3	4
0000-0022	0023-0046	0047-0069	0070-0092	0093-0115
5	6	7	8	9
0116-0139	0140-0162	0163-0185	0186-0208	0209-0232
10				
0233-0255				

• Repeater tone/tone squelch frequency setting

Command: 1B 00, 1B 01

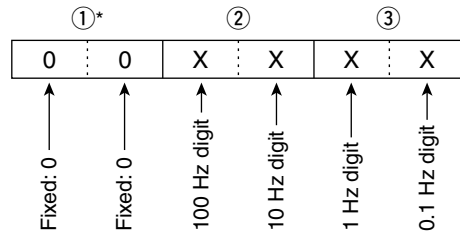

\*Not necessary when setting a frequency.

See page 16-16 for tone frequency list.

• DTCS code and polarity setting

Command : 1B 02

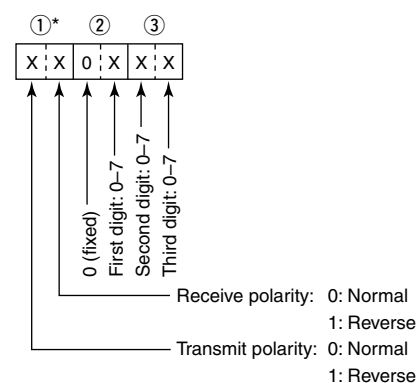

\*See page 16-17 for DTCS code list.



## ■ CI-V information (Continued)

### • Digital code squelch setting

Command : 1B 07

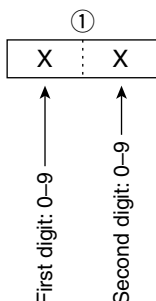

### • DV MY call sign setting

Command : 1F 00

Set your own call sign and note of up to 12 characters.

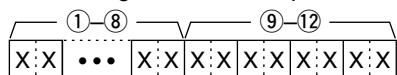

①-⑧ : Your own call sign setting (8 characters)

⑨-⑫ : Note setting (4 characters)

### • DV TX call signs setting (24 characters)

Command : 1F 01

Set "UR," "R1" and "R2" call signs of 8 characters (fixed).

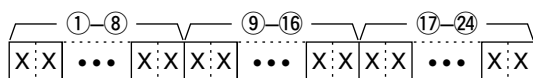

①-⑧: UR (Destination) call sign setting (8 characters)

⑨-⑮: R1 (Access/Area **repeater**) call sign setting (8 characters)

⑰-⑳: R2 (Link/Gateway repeater) call sign setting (8 characters)

### • Character's code of the call sign

Character	ASCII code
0-9	30-39
A-Z	41-5A
(Space)	20
/	2F

### • DV TX message setting

Command : 1F 02

Set the transmit message of up to 20 characters. "FF" stops sending or reading messages.

Character	ASCII code	Character	ASCII code
A-Z	41-5A	a-z	61-7A
0-9	30-39	Space	20
!	21	#	23
\$	24	%	25
&	26	\	5C
?	3F	"	22
'	27	`	60
^	5E	+	2B
-	2D	*	2A
/	2F	.	2E
,	2C	:	3A
;	3B	=	3D
<	3C	>	3E
(	28	)	29
[	5B	]	5D
{	7B	}	7D
!	7C	_	5F
-	7E	@	40

### • DV RX Status setting

Command : 20 0201, 20 0202

Data	Function	Description
bit7	0 (Fixed)	—
bit6	0/1 Receiving a voice call	During receiving a digital voice signal, select "1." (Regardless of DSQ and CSQ setting)
bit5	0/1 Last call finisher	When the last call was finished by you, select "1."
bit4	0/1 Receiving a signal	When the audio tone can be heard, select "1."
bit3	0/1 Receiving a BK call	During receiving a BK call, select "1."
bit2	0/1 Receiving a EMR call	During receiving a EMR call, select "1."
bit1	0/1 Receiving a signal other than DV	When "DV" and "FM" are blinking, select "1."
bit0	0/1 Packet loss status	During displaying a packet loss

## 17 OTHER FUNCTIONS

### ■ CI-V information (Continued)

#### • DV RX call sign setting

Command : 20 0001, 20 0002

##### ① Header flag data (First byte)

Data		Description
bit7	(0: Fixed)	—
bit6	(0: Fixed)	—
bit5	(0: Fixed)	—
bit4	0/1	0= Voice, 1= Data
bit3	0/1	0= Direct, 1= Through repeater
bit2	0/1	0= No Break-in, 1= Break-in
bit1	0/1	0= Data, 1= Control
bit0	0/1	0= Normal, 1= EMR

##### ② Header flag data (Second byte)

Data			Description
bit2	bit1	bit0	
1	1	1	Repeater control
1	1	0	Send auto acknowledge
1	0	1	(Not used)
1	0	0	Request to re-transmit
0	1	1	Send acknowledge
0	1	0	Receive no reply
0	0	1	Repeater disabled
0	0	0	NULL

③–⑩: Call sign of the caller station (8 characters; fixed)

⑪–⑭: Note of the caller station (4 characters; fixed)

⑮–⑲: Call sign of the called station (8 characters; fixed)

⑳–㉓: Call sign of the access/area **repeater** (R1) (8 characters; fixed)

㉔–㉗: Call sign of the link/gateway repeater (R2) (8 characters; fixed)

• "FF" stands for no call sign receiving after turning ON the transceiver.

#### • DV RX message

Command: 20 0101, 20 0102

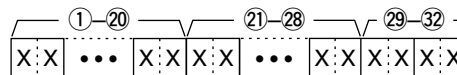

①–⑳: Message (20 characters)

㉑–㉔: Call sign of the caller station (8 characters)

㉕–㉗: Note of the caller station (4 characters)

• "FF" stands for no call sign is received since the transceiver power ON.

# Section 18    OPTIONS

---

- Option list ..... 18-2
- Optional HM-75LS
  - REMOTE CONTROL SPEAKER MICROPHONE ..... 18-4
  - ◇ Remote control function setting ..... 18-4
- VOX function ..... 18-5
  - ◇ Optional unit connection ..... 18-5
  - ◇ Selecting the headset type ..... 18-5
  - ◇ Turning the VOX function ON or OFF ..... 18-6
  - ◇ VOX Level setting ..... 18-7
  - ◇ VOX-related settings ..... 18-8
- SJ-1 SILICONE JACKET ..... 18-8

## ■ Option list

• **HM-186LS**

**SPEAKER-MICROPHONE**  
For operation while conveniently hanging the transceiver from your belt, and so on.

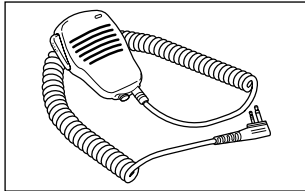

• **HM-75LS**

**REMOTE CONTROL SPEAKER MICROPHONE**  
Allows you to remotely select operating channels, and other functions.

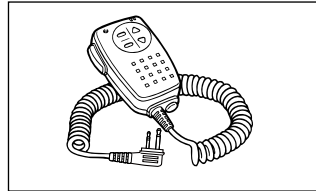

• **OPC-254L**

**DC POWER CABLE**  
For operation and charging using an external power supply.

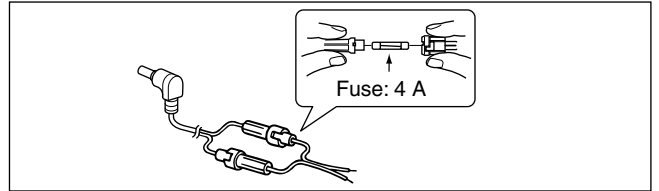

• **HM-153LS/HM-166LS**

**EARPHONE-MICROPHONE**  
Ideal for hands-free operation: clip the HM-153LS/HM-166LS (with integrated PTT switch) to your lapel or breast pocket. Allows you to operate in rainy condition.

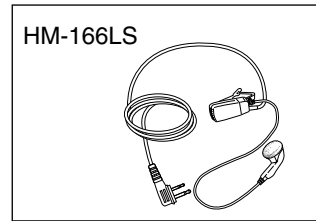
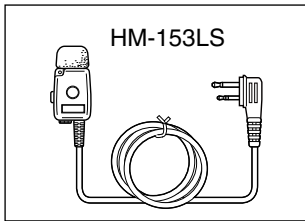

• **BC-202 DESKTOP CHARGER+BC-123SA/SE AC ADAPTER**  
Rapidly charges the BP-271 LI-ION BATTERY PACK in approximately 2 hours.  
Rapidly charges the BP-272 LI-ION BATTERY PACK in approximately 3.5 hours.

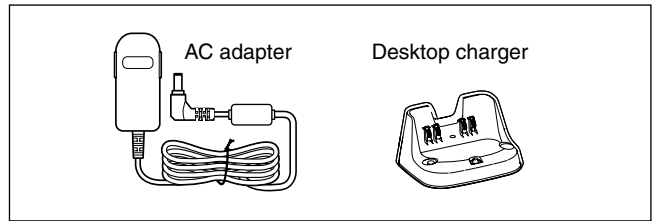

• **CP-12L** CIGARETTE LIGHTER CABLE WITH NOISE FILTER

• **CP-19R** CIGARETTE LIGHTER CABLE WITH DC-DC CONVERTER  
Allows you to operate the transceiver through a 12 V cigarette lighter socket. You can also charge the attached battery pack. (By default, the battery pack cannot be charged during power ON.)  
CP-19R: A built-in DC-DC converter provides an 11 V DC output.

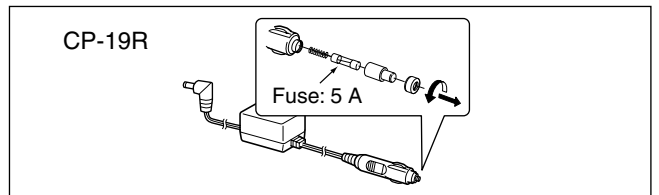
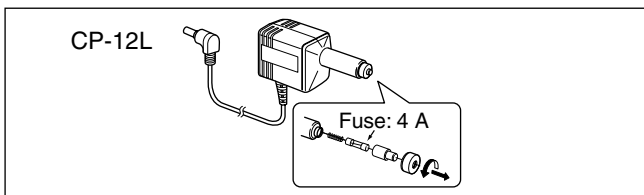

## ■ Option list (Continued)

### ◇ BATTERY PACK/CASE

- **BP-271** LI-ION BATTERY PACK  
7.4 V/1150 mAh (Min.) Lithium ion battery pack.  
Battery life : Approximately 4.5 hours\* (FM/DV)
- **BP-272** LI-ION BATTERY PACK  
7.4 V/1880 mAh (Min.) Lithium ion battery pack.  
Battery life : Approximately 7.5 hours\* (FM)  
Approximately 6 hours\* (DV)
- **BP-273** BATTERY CASE  
Battery case for three LR6 (AA) alkaline batteries.

\*At High power, TX : RX: Standby = 1:1:8

### ◇ CHARGERS

- **BC-167SA/SD/SV** BATTERY CHARGER  
For regular charging of the BP-271 or BP-272 Lithium ion battery pack.  
Same as the supplied one. (Not supplied with some transceiver version.)

### ◇ CLONING SOFTWARE

- **CS-51** CLONING SOFTWARE (free download)  
Use this software to program settings such as memory channels and Menu mode contents quickly and easily through your USB port (OPC-2218LU).
- **OPC-2218LU** DATA COMMUNICATION CABLE  
Allows low-speed data communication in the DV mode, or data cloning with CS-51 (free download software).

### ◇ OTHER OPTIONS

- **SP-13** EARPHONE  
Provides clear audio in noisy environments.
- **HM-75A/HM-153/HM-166/HM-186** MICROPHONE or **SP-13** EARPHONE + **OPC-2144** PLUG ADAPTER CABLE  
HM-75A : Remote control Speaker microphone  
HM-153 : Earphone microphone  
HM-166 : Earphone microphone  
HM-186 : Speaker microphone  
SP-13 : Earphone  
OPC-2144 : Allows you to connect the HM-75A/HM-153/HM-166/HM-186/SP-13 to the transceiver.
- **HS-94/HS-95/HS-97** HEADSET  
+ **OPC-2006LS** PLUG ADAPTER CABLE  
HS-94 : Ear hook type  
HS-95 : Neck & arm type  
HS-97 : Throat microphone  
OPC-2006LS : Allows you to connect the HS-94/HS-95/HS-97 to the transceiver. After connecting, the VOX function can be used.
- **LC-179** CARRYING CASE  
Helps protect the transceiver from scratches, and so on.
- **SJ-1** SILICONE JACKET
- **AD-92SMA** ANTENNA CONNECTOR ADAPTER  
Allows you to connect an antenna or antenna cable with a BNC connector.
- **CT-17** CI-V LEVEL CONVERTER UNIT  
For remote transceiver control using a personal computer equipped with an RS-232C port. You can change frequencies, operating mode, memory channels, and so on, using your computer.

Approved Icom optional equipment is designed for optimal performance when used with an Icom transceiver.

Icom is not responsible for the destruction or damage to an Icom transceiver in the event the Icom transceiver is used with equipment that is not manufactured or approved by Icom.



## ■ Optional HM-75LS REMOTE CONTROL SPEAKER MICROPHONE

The optional HM-75LS allows you to remotely select operating frequencies, memory channels, and others. The function assignments for keys can be changed in the MENU screen for simple remote control operation. (p. 16-67)  
 (MENU > Function > **Remote MIC Key**)

The HM-75LS has a lock switch on the backside to prevent accidental frequency changes, and so on.

▨ Be sure to turn OFF power when plugging or unplugging the HM-75LS into or from the [MIC/SP] jack.

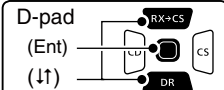
### ◇ Remote control function setting

- ① Push [MENU] .
  - ② Push D-pad(↑) to select the root item ("Function"), and then push D-pad(Ent).
- 
- ③ Push D-pad(↓) to select "Remote MIC Key," and then push D-pad(Ent).
  - ④ Push D-pad(↑) to select "During RX/Standby" or "During TX," and then push D-pad(Ent).
    - Example: During RX/Standby
  - ⑤ Push D-pad(←) to select the desired key, and then push D-pad(Ent).
    - Example: [A]
  - ⑥ Push D-pad(↑) to select the desired key function, and then push D-pad(Ent).
    - Example: "TO (DR)"
  - ⑦ Push [MENU]  to save, and exit the MENU screen.

### ✓ Information— Returning to default

#### All key functions:

Push [QUICK]  in the "During RX/Standby" or "During TX" screen, then push D-pad(Ent) to return all key functions to their default setting.

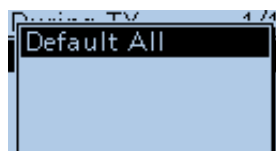

#### Each key function:

Push [QUICK]  in the key function list screen of each key, and then push D-pad(Ent) to return to the key's default setting.

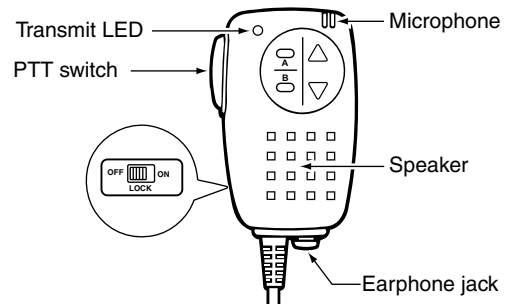
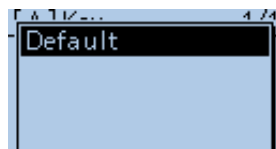

Example: To change the remote control function assigned to [A] from "BAND" to "TO(DR)."

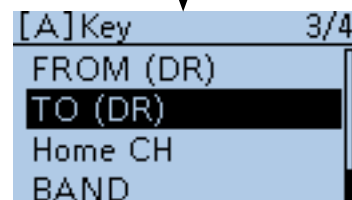
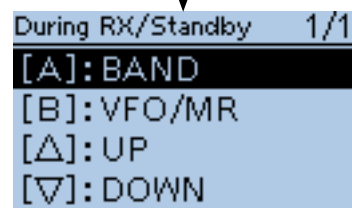
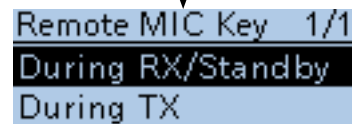
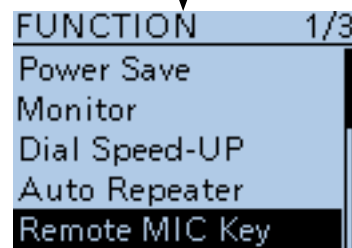
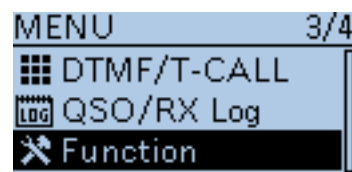

Key function list for [A] key

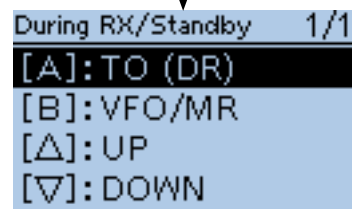

## ■ VOX function

The transceiver has a VOX function, which allows hands-free operation.

An optional HS-94, HS-95 or HS-97 headset and the OPC-2006LS plug adapter cable are also required.

- The VOX (voice operated transmission) function starts transmission when you speak into the microphone, without needing to push [PTT]. It then automatically returns to reception when you stop speaking.

**NOTE:** Set the external microphone gain before setting the VOX gain in the MENU screen. We recommend you set the microphone gain level to 3. (MENU > Function > **MIC Gain (External)**)

### ◇ Optional unit connection

- ① Turn OFF the transceiver.
- ② Lift up the jack cover.
- ③ Connect the HS-94, HS-95 or HS-97 and the OPC-2006LS, as illustrated to the right.

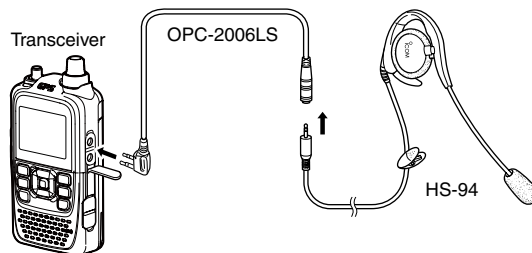

Be sure to turn OFF power when plugging in or unplugging the OPC-2006LS into or from the [MIC/SP] jack.

### ◇ Selecting the headset type

Before using the VOX function, select the headset type.

- ① Turn ON the transceiver.
- ② Push [MENU] .
- ③ Push D-pad(↑) to select the root item ("Function"), and then push D-pad(Ent) to go to the next screen.

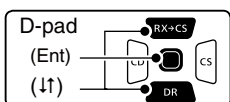

(MENU > Function > VOX > **Headset Select**)

- ④ Refer to the menu sequence shown directly above and push D-pad(↑) to select, and then D-pad(Ent) to enter, one or more times until the last screen is displayed.
- ⑤ Push D-pad(↑) to select the option.  
 HS-95 : Select when using the HS-95.  
 Other : Select when using the HS-94 or HS-97.
- ⑥ Push [MENU]  to exit the MENU screen.

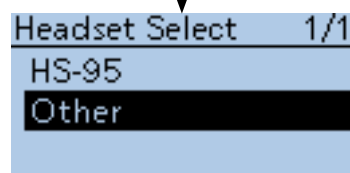
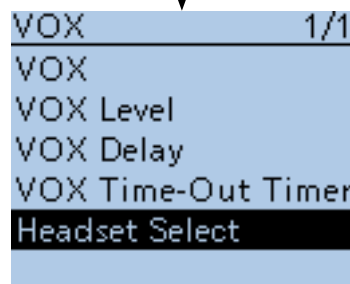
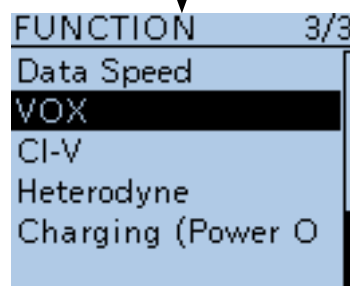
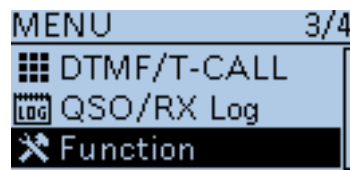

■ VOX function (Continued)

◇ Turning the VOX function ON or OFF

- ① Push [MENU] .
- ② Push D-pad(↑) to select the root item (“Function”), and then push D-pad(Ent) to go to the next screen.

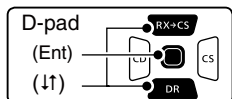

(MENU > Function > VOX > **VOX**)

- ③ Refer to the menu sequence shown directly above and push D-pad(↓) to select, and then D-pad(Ent) to enter, one or more times until the last screen is displayed.
- ④ Push D-pad(↓) to select “ON.”
- ⑤ Push [MENU]  to exit the MENU screen.
  - “VOX” appears.

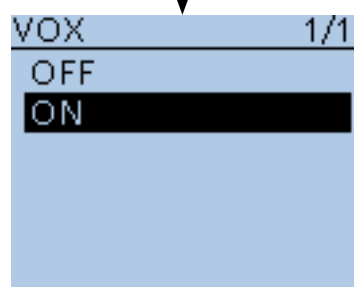
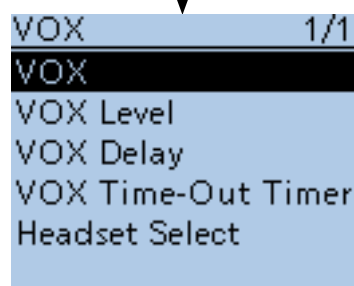
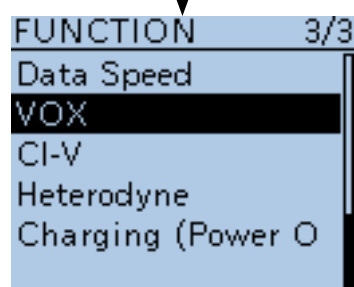

Appears

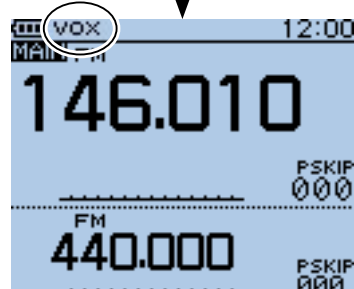



■ VOX function (Continued)

◇ **VOX Level setting**

/// **NOTE:** Set the external microphone gain before setting the VOX gain in the MENU screen. We recommend you set the microphone gain level to 3.  
 /// (MENU > Function > **MIC Gain (External)**)

- ① Push [MENU] .
- ② Push D-pad(↓) to select the root item (“Function”), and then push D-pad(Ent) to go to the next screen.

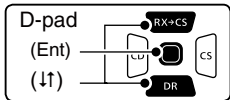

(MENU > Function > VOX > **VOX Level**)

- ③ Refer to the menu sequence shown directly above and push D-pad(↓) to select, and then D-pad(Ent) to enter, one or more times until the last screen is displayed.
- ④ While speaking into the headset microphone, rotate [DIAL] to adjust the VOX Level until “VOX” continuously appears.
  - The VOX Level can be adjusted between 1 (minimum) and 10 (maximum), or turned OFF. Higher values make the VOX function more sensitive to your voice. (Default: 5)
- ⑤ Push [MENU]  to exit the MENU screen.

- /// • If the TX/RX indicator blinks, set the VOX Delay in the MENU screen. (p. 16-70) (MENU > Function > VOX > **VOX Delay**)
- /// • When the VOX function is ON, you can adjust the VOX level by rotating [DIAL] while transmitting.

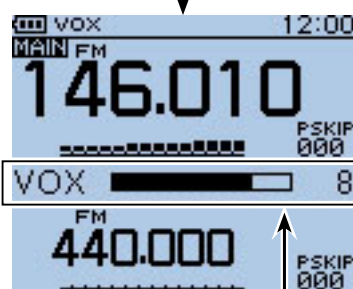
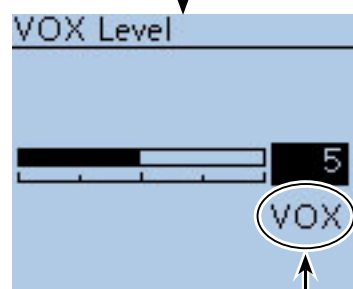
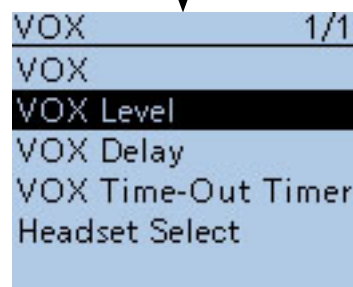
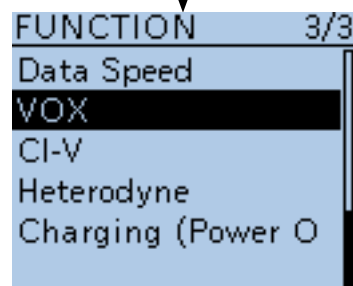

■ VOX function (Continued)

◇ **VOX-related settings**

The VOX Delay and the VOX time-out timer can be set in the MENU screen.

• **VOX delay**

Sets the VOX delay to between 0.5 and 3.0 seconds (in 0.5 seconds steps). The VOX delay is the amount of time the transmitter stays ON after you stop speaking. (Default: 0.5)

(MENU > Function > VOX > **VOX Delay**)

▨ If “VOX” is intermittent, set the VOX delay long enough to allow normal pauses in speech, but turn OFF the VOX after you finish speaking.

• **VOX time-out timer**

Sets the VOX Time-Out Timer to between 1, 2, 3, 4, 5, 10 and 15 minutes to prevent accidental prolonged transmission.

To turn OFF the function, select “OFF.” (Default: 3)

(MENU > Function > VOX > **VOX Time-out Timer**)

▨ The VOX Time-Out Timer must be set shorter than the transceiver Time-Out Timer, otherwise this timer will not be activated.

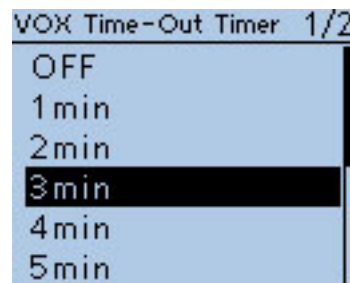
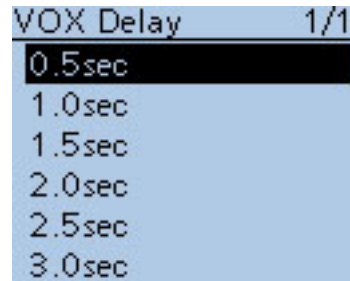

■ **SJ-1 SILICONE JACKET**

The SJ-1 SILICONE JACKET can be used when the BP-271 BATTERY PACK is attached to the transceiver.

When the BP-272 BATTERY PACK or BP-273 BATTERY CASE is attached, the jacket cannot be used.

▨ Before attaching or removing the jacket, be sure to disconnect the antenna from the transceiver.

**To attach:**

- ① Place the antenna connector and [DIAL] of the transceiver into the holes on the top of the jacket, as shown to the right.
- ② Pull the jacket around the sides and bottom of the transceiver.
  - When the belt clip is attached, push it out from the hole on back of the jacket.

**To remove:**

- ① Remove the jacket from bottom of the transceiver.
  - If a belt clip is attached, pull the jacket around the bottom of the clip.
- ② Pull the antenna connector and [DIAL] from the jacket, and remove it from the transceiver.

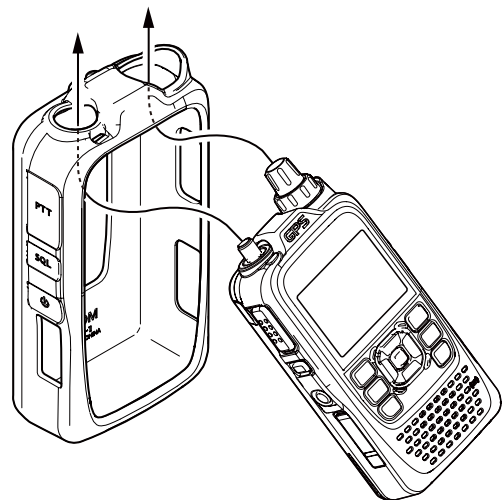

# Section 19 SPECIFICATIONS

---

■ Transceiver .....	19-2
◇ General.....	19-2
◇ Transmitter.....	19-2
◇ Receiver .....	19-3
■ BC-202 DESKTOP CHARGER .....	19-3

## ■ Transceiver

### ◇ General

- Frequency coverage : (unit: MHz)

EUR, KOR	TX	144–146, 430–440
	RX	144–146, 430–440
UK	TX	144–146, 430–440
	RX	108–174* <sup>1</sup> , 380–479* <sup>2</sup>
ITR	TX	144–146, 430–434, 435–438
	RX	108–136.995,* <sup>1</sup> 144–146, 430–434, 435–438
U.S.A.	TX	144–148, 430–450* <sup>3</sup>
	RX	108–174* <sup>4</sup> , 380–479* <sup>3</sup>
EXP	TX	137–174* <sup>4</sup> , 400–479* <sup>2</sup>
	RX	108–174* <sup>4</sup> , 380–479* <sup>2</sup>
EXP-1	TX	144–148, 430–440
	RX	108–174* <sup>4</sup> , 380–479* <sup>2</sup>
ALL	RX	BC Radio (AM): 0.520–1.710 kHz
		BC Radio (FM): 76.0–108.0 MHz* <sup>5</sup>

\*<sup>1</sup>Guaranteed 144–146 MHz only

\*<sup>2</sup>Guaranteed 430–440 MHz only

\*<sup>3</sup>Guaranteed 440–450 MHz only

\*<sup>4</sup>Guaranteed 144–148 MHz only

\*<sup>5</sup>88.0–108.0 MHz for the USA version transceiver.

/// The SUB band audio signal may be muted, depending on the combination of operating band and mode.

- Mode : FM, AM (Rx only), DV
- Number of memory channels : 554  
(incl. 50 scan edges and 4 call channels)
- Number of BC radio memory channels : 500
- Usable temp. range : –20°C to +60°C; –4°F to +140°F
- Tuning steps : 1, 5, 6.25, 8.33, 9, 10, 12.5, 15, 20, 25, 30, 50, 100, 125 and 200 kHz  
\*The selectable steps may differ, depending on the selected frequency band or operating mode.
- Frequency stability : ±2.5 ppm  
(–20°C to +60°C; –4°F to +140°F)
- Power supply : 10.0–16.0 V DC for external DC power, or specified Icom's battery pack
- Digital transmission speed : 4.8 kbps
- Voice coding speed : 2.4 kbps
- Current drain (at 7.4 V DC) :  
TX (at 5 W) : Less than 2.5 A  
RX Max. output FM : Less than 350 mA (Internal speaker)  
Less than 200 mA (External speaker)  
DV : Less than 450 mA (Internal speaker)  
Less than 300 mA (External speaker)
- Antenna connector : SMA (50 Ω)
- Dimensions : 58(W)×105.4(H)×26.4(D) mm;  
(projections not included) 2.3(W)×4.1(H)×1.0(D) in
- Weight (approximately) : 255 g; 9 oz  
(incl. battery pack and antenna)

### ◇ Transmitter

- Modulation system :  
FM : Variable reactance freq. modulation  
DV : GMSK reactance freq. modulation
- Output power (at 7.4 V DC) : High 5.0 W, Mid. 2.5 W, Low2 1.0 W, Low1 0.5 W, S-Low 0.1 W (Typical)
- Max. frequency deviation : ±5.0 kHz (FM wide: approx.)  
±2.5 kHz (FM narrow: approx.)
- Spurious emissions : Less than –60 dBc at High/Mid.  
Less than –13 dBm at Low2/Low1/S-Low
- Ext. mic. impedance : 2.2 kΩ

All stated specifications are subject to change without notice or obligation.

## 19 SPECIFICATIONS

### ■ Transceiver (Continued)

#### ◇ Receiver

- Receive system : Double-conversion superheterodyne
- Intermediate frequencies
  - A Band : 46.35 MHz (1st IF)  
: 450 kHz (2nd IF)
  - B Band : 61.65 MHz (1st IF)  
: 450 kHz (2nd IF)
- Sensitivity (except spurious points)
  - AM (1 kHz 30% MOD; 10 dB S/N)
    - 0.520 to 0.995 MHz : Less than +10 dB $\mu$
    - 1.000 to 1.710 MHz : Less than +5 dB $\mu$
    - 108.000 to 136.995 MHz : Less than +5 dB $\mu$
  - FM (1 kHz/3.5 kHz Dev.; 12 dB SINAD)
    - 137.0 to 174.0 MHz
      - Amateur band only : Less than -15 dB $\mu$
      - Except for Amateur band : Less than -10 dB $\mu$
    - 380.0 to 479.0 MHz
      - Amateur band only : Less than -15 dB $\mu$
      - Except for Amateur band : Less than -10 dB $\mu$
  - WFM (1 kHz/52.5 kHz Dev.; 12 dB SINAD)
    - 76.0 to 81.9 MHz : Less than +10 dB $\mu$
    - 82.0 to 108.0 MHz : Less than +5 dB $\mu$
  - DV (PN9/GMSK 4.8 kbps; BER 1%)
    - 137.0 to 174.0 MHz
      - Amateur band only : Less than -11 dB $\mu$
    - 380.0 to 479.0 MHz
      - Amateur band only : Less than -11 dB $\mu$
- Audio output power (at 10% distortion)
  - Internal speaker : More than 0.4 W with a 16  $\Omega$  load
  - External speaker : More than 0.2 W with a 8  $\Omega$  load
- Selectivity
  - FM (Wide) : More than 55 dB
  - FM (Narrow), DV : More than 50 dB
- Ext. speaker connector : 3-conductor 3.5(d) mm; (1/8")/8  $\Omega$
- Spurious and image rejection ratio : More than 60 dB
- Squelch Sensitivity (except spurious points)
  - AM (1 kHz 30% MOD; 10 dB S/N) (threshold)
    - 0.520 to 0.995 MHz : Less than +10 dB $\mu$
    - 1.000 to 1.710 MHz : Less than +5 dB $\mu$
    - 108.000 to 136.995 MHz : Less than +5 dB $\mu$
  - FM (1 kHz/3.5 kHz Dev.; 12 dB SINAD) (threshold)
    - 137.0 to 174.0 MHz
      - Amateur band only : Less than -15 dB $\mu$
      - Except for Amateur band : Less than -10 dB $\mu$
    - 380.0 to 479.0 MHz
      - Amateur band only : Less than -15 dB $\mu$
      - Except for Amateur band : Less than -10 dB $\mu$
  - WFM (1 kHz/52.5 kHz Dev.; 12 dB SINAD) (threshold)
    - 76.0 to 81.9 MHz : Less than +15 dB $\mu$
    - 82.0 to 108.0 MHz : Less than +10 dB $\mu$

### ■ BC-202 DESKTOP CHARGER

- Power supply requirement : 12 to 16 V DC or the specified Icom AC adapter (BC-123S)
- Charging temperature range : 0°C to +40°C; +32°F to +104°F
- Weight : Approximately 104 g; 3.7 oz (without AC adapter)
- Dimensions : 88(W)×72.6(D)×46.5(H) mm; 3.5(W)×2.9(D)×1.8(H) in. (projection is not included)

# TROUBLESHOOTING

The following chart is designed to help you correct problems which are not equipment malfunctions. If you are unable to locate the cause of a problem or solve it through the use of this chart, contact your nearest Icom Dealer or Service Center.

## ◇ While operating D-STAR

PROBLEM	POSSIBLE CAUSE	SOLUTION	REF.
After your call, the repeater does not return a status reply.	<ul style="list-style-type: none"> <li>The repeater setting is wrong.</li> <li>Your transmission did not reach the repeater.</li> </ul>	<ul style="list-style-type: none"> <li>Select the correct repeater.</li> <li>Correct the repeater frequency, frequency offset, or duplex setting.</li> <li>Wait until you are closer to the repeater and try again.</li> <li>Try to access another repeater.</li> </ul>	<p>p. 8-2 pp. 9-28, 9-29</p> <p>—</p> <p>—</p>
After your call, the repeater replies 'UR?' and its call sign.	<ul style="list-style-type: none"> <li>The call was successfully sent, but no station immediately replied.</li> </ul>	<ul style="list-style-type: none"> <li>Wait for a while, and try again.</li> </ul>	—
After your call, the repeater replies 'RX' or 'RPT?' and the access repeater's call sign.	<ul style="list-style-type: none"> <li>Your own call sign (MY) has not been set.</li> <li>Your own call sign (MY) has not been registered on a gateway repeater, or the registered contents do not match your transceiver's setting.</li> </ul>	<ul style="list-style-type: none"> <li>Set your own call sign (MY).</li> <li>Register your own call sign (MY) on a gateway repeater, or confirm the registration of the call sign.</li> </ul>	<p>p. 2 of the Basic Instruction p. 4 of the Basic Instruction</p>
After your call, the repeater replies 'RPT?' and call sign of the destination repeater.	<ul style="list-style-type: none"> <li>The repeater cannot connect to the destination repeater.</li> <li>The repeater is busy.</li> </ul>	<ul style="list-style-type: none"> <li>Check the repeater setting.</li> <li>Wait for a while, and try it again.</li> </ul>	<p>p. 9-23</p> <p>—</p>
After your call, the access repeater replies 'RPT?' and its call sign.	<ul style="list-style-type: none"> <li>The call sign of the destination repeater is wrong.</li> </ul>	<ul style="list-style-type: none"> <li>Correctly set the destination repeater call sign.</li> </ul>	p. 9-26
Even holding down <b>DR</b> , the DR mode will not appear.	<ul style="list-style-type: none"> <li>There is no repeater list in your radio.</li> </ul>	<ul style="list-style-type: none"> <li>Reload the repeater list using the CS-51 cloning software on the CD.</li> <li>Reload the repeater list using a microSD card.</li> <li>Enter the Repeater list data directly into the transceiver.</li> </ul>	<p>p. 17-20</p> <p>p. 2-13</p> <p>p. 9-23</p>
Even holding down <b>RX→CS</b> , the received call sign will not set to the destination call sign.	<ul style="list-style-type: none"> <li>The call sign has not been correctly received.</li> <li>When a received signal is weak, or a signal is received during scanning, the call sign may not be received correctly. In that case, "-----" appears and error beeps sound, and a reply call cannot be made.</li> </ul>	<ul style="list-style-type: none"> <li>Try it again, after the transceiver has correctly received the call sign.</li> </ul>	—
A Local area call can be made, but the Gateway call or destination station call cannot be made.	<ul style="list-style-type: none"> <li>MY call sign has not been registered on a D-STAR repeater.</li> </ul>	<ul style="list-style-type: none"> <li>Register your own call sign (MY) on a gateway repeater, or confirm the registration of the call sign.</li> </ul>	p. 4 of the Basic Instruction
During transmission, "L" appears on the LCD, and the received audio is interrupted.	<ul style="list-style-type: none"> <li>While receiving through the internet, some packets may be lost due to network error (poor data throughput performance).</li> </ul>	<ul style="list-style-type: none"> <li>Wait a while, and try it again.</li> <li>When the transceiver receives corrupted data, and misidentifies it as Packet Loss, "L" is displayed, even if it is a Local area call.</li> </ul>	—
"DV" and "FM" icons alternately blink.	<ul style="list-style-type: none"> <li>While in the DV mode, an FM signal is received.</li> </ul>	<ul style="list-style-type: none"> <li>Use a different operating frequency until there are no FM signals on the original frequency.</li> </ul>	p. 9-10

## TROUBLESHOOTING

### ◇ While operating D-STAR (Continued)

PROBLEM	POSSIBLE CAUSE	SOLUTION	REF.
The <b>simplex</b> operation cannot be made in the DR mode.	<ul style="list-style-type: none"> <li>• A call sign is programmed in "CALL SIGN" of the Repeater list.</li> <li>• <b>Duplex</b> mode (DUP+, DUP-) is set.</li> <li>• A <b>repeater</b> frequency is programmed.</li> </ul>	<ul style="list-style-type: none"> <li>• Delete the Call sign in "CALL SIGN" setting of the Repeater list.</li> <li>• Select "OFF" in "DUP" setting of the repeater list.</li> <li>• Set a simplex frequency.</li> </ul>	<p>p. 9-26</p> <p>p. 9-29</p> <p>p. 9-27</p>
The digital code squelch (CSQL) is impossible.	<ul style="list-style-type: none"> <li>• The wrong digital code is set.</li> </ul>	<ul style="list-style-type: none"> <li>• Set the correct digital code.</li> </ul>	p. 9-20
You don't know how to update the repeater list.	—	<ul style="list-style-type: none"> <li>• See "Updating the repeater list" to check.</li> </ul>	p. 2-13

### ◇ While operating GPS Logger

PROBLEM	POSSIBLE CAUSE	SOLUTION	REF.
Position data cannot be received.	<ul style="list-style-type: none"> <li>• "External GPS" is selected in the GPS Set item on the Menu screen, but an external GPS receiver is not connected.</li> <li>• "OFF" or "Manual" is selected in the GPS Set item on the Menu screen.</li> <li>• A GPS signal was not received.</li> </ul>	<ul style="list-style-type: none"> <li>• Connect an external GPS receiver.</li> <li>• Select either "Internal GPS" or "External GPS" in the GPS Set item on the Menu screen.</li> <li>• Move until the GPS signal is received.</li> </ul>	<p>p. 10-2</p> <p>p. 10-2</p> <p>—</p>

## TROUBLESHOOTING

### ◇ Others

PROBLEM	POSSIBLE CAUSE	SOLUTION	REF.
Transceiver does not turn ON.	<ul style="list-style-type: none"> <li>The battery is exhausted.</li> <li>The battery polarity is reversed.</li> <li>Loose connection of a battery pack (case).</li> </ul>	<ul style="list-style-type: none"> <li>Charge the battery pack, or replace the batteries.</li> <li>Check the battery polarity in the case.</li> <li>Clean the battery terminals.</li> </ul>	<p>pp. 4-3, 4-4</p> <p>p. 4-4 pp. 4-3, 4-4</p>
No sound comes from the speaker.	<ul style="list-style-type: none"> <li>Volume level is too low.</li> <li>An external speaker or a cloning cable is connected to the [SP] jack.</li> </ul>	<ul style="list-style-type: none"> <li>Rotate [VOL] to adjust to a desired level.</li> <li>Check the external speaker connection or remove the cloning cable.</li> </ul>	<p>p. 5-2</p> <p>—</p>
Sensitivity is too low, and only strong signals are audible.	<ul style="list-style-type: none"> <li>The coaxial cable is not connected, or shorted. (External antenna is used)</li> </ul>	<ul style="list-style-type: none"> <li>Check the coaxial cable connection or replace with the new.</li> </ul>	—
Transmitting is impossible.	<ul style="list-style-type: none"> <li>The transmit power level is set to S-LOW, LOW1 or LOW2</li> <li>The battery is exhausted.</li> <li>The battery case is attached.</li> <li>The PTT Lock function is activated.</li> <li>The Busy Lockout function is activated.</li> </ul>	<ul style="list-style-type: none"> <li>Set the transmit power level to HIGH.</li> <li>Charge the battery pack, or replace the batteries.</li> <li>Use the battery pack or external DC power, and set the transmit power level to HIGH.</li> <li>Set the PTT Lock function to OFF in the Function Menu.</li> <li>Set the Busy Lockout function to OFF in the Function Menu.</li> </ul>	<p>p. 5-10</p> <p>pp. 4-3, 4-4</p> <p>p. 4-6</p> <p>p. 16-68</p> <p>p. 16-68</p>
No reply is received after a call.	<ul style="list-style-type: none"> <li>The <b>duplex</b> is set, and the receive and transmit frequencies are different.</li> <li>No station is in range or on the same frequency.</li> </ul>	<ul style="list-style-type: none"> <li>Set the <b>simplex</b> operation.</li> <li>Wait for a while, and try again.</li> </ul>	p. 15-5
Transmitting using the VOX function is impossible.	<ul style="list-style-type: none"> <li>The VOX Level is set to OFF or too low.</li> <li>The MIC Gain is too low.</li> </ul>	<ul style="list-style-type: none"> <li>Set the VOX Level to a suitable level.</li> <li>Set the MIC Gain to a suitable level.</li> </ul>	<p>p. 16-69</p> <p>p. 16-69</p>
Contacting another station is impossible.	<ul style="list-style-type: none"> <li>A different tone or code is used for the tone/DTCS squelch.</li> </ul>	<ul style="list-style-type: none"> <li>Check the tone/DTCS by performing a tone scan.</li> </ul>	p. 13-2
Frequency cannot be set.	<ul style="list-style-type: none"> <li>The Key Lock function is activated.</li> <li>The memory mode, Call channel mode, Weather channel mode* or DR mode is selected. *USA version transceiver only</li> </ul>	<ul style="list-style-type: none"> <li>Hold down [LOCK]<sup>[MENU]</sup> for 1 second to cancel the Key Lock function.</li> <li>Push [V/MHz]<sup>[CLR LOW]</sup> to select the VFO mode.</li> </ul>	<p>p. 5-11</p> <p>p. 5-8</p>
A Program Scan does not start.	<ul style="list-style-type: none"> <li>The memory mode, Call channel mode, Weather channel mode* or DR mode is selected. *USA version transceiver only</li> <li>The same frequency has been programmed in the scan edge channels, “*A” and “*B.”</li> <li>Only one scan edge channel has been programmed.</li> </ul>	<ul style="list-style-type: none"> <li>Push [V/MHz]<sup>[V/MHz CLR LOW]</sup> to select the VFO mode.</li> <li>Program different frequencies in the scan edge channels.</li> <li>Program one or more pair of the scan edge channels.</li> </ul>	<p>p. 5-8</p> <p>p. 12-4</p> <p>p. 12-4</p>
A Memory Scan does not start.	<ul style="list-style-type: none"> <li>The Memory mode is not selected.</li> <li>Only one or no memory channel has been programmed.</li> </ul>	<ul style="list-style-type: none"> <li>Push [M/CALL]<sup>[M/CALL S.MW]</sup> to select the Memory mode.</li> <li>Program two or more memory channels.</li> </ul>	<p>p. 5-8</p> <p>p. 12-4</p>
The displayed frequency is erroneous.	<ul style="list-style-type: none"> <li>The CPU has malfunctioned.</li> <li>External factors have caused a fault.</li> </ul>	<ul style="list-style-type: none"> <li>Reset the transceiver.</li> <li>Remove and reattach the battery pack/case.</li> </ul>	<p>p. 16-86</p> <p>p. 1-2</p>



---

## TROUBLESHOOTING

### ◇ Others (Continued)

<b>PROBLEM</b>	<b>POSSIBLE CAUSE</b>	<b>SOLUTION</b>	<b>REF.</b>
The SUB band audio signal is muted.	• The combination of operating band and mode is incorrect.	• Change the settings.	p. 5-13
A distorted noise is heard when the earphone is used.	• The earphone mode is OFF.	• Turn ON the earphone mode.	p. 16-78
Charging is impossible at power ON.	• “Charging (Power ON)” setting is OFF (default).	• Set the “Charging (Power ON)” setting to ON in the Function Menu.*	p. 16-71

\*This operation may generate certain spurious signals; the S-meter appears, or noise may be heard.

# INDEX

- 1
- 1750 Hz tone ..... 15-7
- A**
- AF Tone for the DV mode
- RX Bass, setting ..... 16-55
  - RX Bass Boost, setting ..... 16-55
  - RX Treble, setting ..... 16-55
  - TX Bass, setting ..... 16-55
  - TX Treble, setting ..... 16-55
- AM radio mode, selection ..... 6-5
- Antenna, installing ..... 1-2
- ATT (AIR) function, setting ..... 5-11
- Attenuator function, setting ..... 6-6
- Audio volume level, setting ..... 5-2
- Audio volume level (BC Radio), setting ..... 6-20
- Automatic Reply function, setting ..... 9-11
- Auto Position Reply function, description ... 9-13
  - Auto Reply voice, playing back/recording ... 9-12
- Auto repeater function, setting ..... 15-6
- B**
- Band Scope function, sweeping ..... 5-12
- Battery
- Replacement ..... 4-4
  - Battery life ..... 4-2
  - Information ..... 4-2
  - Optional battery pack ..... 18-3
  - Optional battery case ..... 4-4, 18-3
- Battery charging
- BC-202 desktop charger ..... 2-2
  - Cautions ..... 4-3, 4-5
  - Through the [DC IN] jack ..... 4-3
  - With the optional desktop charger ..... 4-5
  - External DC power, operation ..... 4-6
  - Optional battery chargers ..... 18-3
- Broadcast (BC) Radio operation ..... 6-2
- Radio mode (AM/FM), selection ..... 6-5
  - Auto Mute, setting ..... 6-18
  - Bank, selection ..... 6-4
  - BC Radio setting ..... 6-17
  - Broadcast signal, searching ..... 6-5
  - Memory ..... 6-9
    - Adding ..... 6-9
    - Deleting ..... 6-12
    - Editing ..... 6-13
    - Rearrange the display order ..... 6-14
  - FM Antenna, selecting ..... 6-17
  - Listening
    - BC Radio Mode ..... 6-16
    - Mode selection ..... 6-3
    - While monitoring two ham bands ..... 6-3
  - Power Save, turning ON/OFF ..... 6-17
  - Skip, setting ..... 6-15
  - Squelch level, setting ..... 6-7
  - Tuning step, setting (AM Only) ..... 6-8
  - Volume Select ..... 6-19
- BK mode, turning ON/OFF ..... 9-7
- C**
- Call channel, selecting ..... 12-3
- Call sign
- Viewing ..... 9-21
  - Your own Call Sign (MY), viewing ..... 16-54
  - Your Call Sign (UR)
    - Memory ..... 16-52
    - Deleting ..... 9-42
    - Programming ..... 9-40
    - Rearrange the display order ..... 9-43
- Compass Direction, changing ..... 10-4
- CI-V
- Data format ..... 17-22
  - Command table ..... 17-23
  - Connection example ..... 17-22
  - Information ..... 17-22
- Cloning
- Cloning function ..... 17-17
  - From a PC
    - Using a microSD card..... 17-20
    - Using an optional data cable ..... 17-20
  - Transceiver-to-Transceiver
    - Using a cable ..... 17-21
    - Using a microSD card ..... 17-17
- D**
- Data communication
- Low-speed data communication ..... 9-14
- Digital call sign squelch, setting ..... 9-19
- Pocket beep function, description ..... 9-19
- Digital code squelch, setting ..... 9-20
- Pocket beep function, description ..... 9-20
- Digital Code, selecting ..... 16-17
- Digital Monitor, setting ..... 16-56
- Digital Repeater Set, turning ON/OFF ..... 16-57
- Digital squelch functions, setting ..... 9-19
- Display ..... 3-5
- Display size in the DR mode, setting ..... 9-9
- D-PRS, description ..... 10-18
- DTCS Squelch, operation ..... 17-15
- Code, selecting ..... 16-17
  - Polarity, selecting ..... 16-17
- ☞ “D” continues on the next page.

INDEX

D (Continued)

DTMF Code

- Memory ..... 17-8
- Monitoring ..... 17-9
- Programming ..... 17-8
- Transmission ..... 17-10, 17-11
- Transfer speed setting ..... 17-12

Dualwatch operation ..... 5-13

Duplex

- Direction, setting ..... 15-5
- Frequency offset, setting ..... 15-4
- Off band indication ..... 15-5
- Operation ..... 15-4

D-STAR operation

- Automatic Reply function, setting ... 9-11, 16-27
- BK mode, setting ..... 9-7
- Call Sign (☞ See 'Call sign')
- Digital squelch functions ..... 9-19
- Display type, setting ..... 9-9
- DR (D-STAR Repeater) mode ..... 5-8
  - Communication Form ..... 7-3
  - "FROM" (Access repeater) setting ..... 8-2
  - "TO" (Destination) setting ..... 8-8
- DR mode scan, skip setting ..... 9-36
  - Group ..... 9-37
  - Individual ..... 9-36
- DV automatic detection, turning ON/OFF ... 9-10
- DV Auto Reply, recording ..... 16-27
- DV Data TX, setting ..... 16-56
- EMR communication, setting ..... 9-8
- Low-speed data communication ..... 9-14
- Message operation ..... 9-2, 16-54
  - Deleting ..... 9-4
  - Transmission ..... 9-3
- My Call Sign, viewing ..... 16-54
- Received call sign announcement ..... 9-15
- Repeater detail screen, viewing ..... 9-39
- Repeater list (☞ See 'Repeater list')
- RX Call Sign Write, setting ..... 16-57
- RX History
  - Viewing ..... 9-5, 16-50
    - Adding the Repeater information ..... 9-35
- RX Repeater Write, setting ..... 16-57
- RX>CS call sign announcement ..... 9-16
- TX Message, programming ..... 16-54

E

EMR

- AF level, setting ..... 9-9
- EMR setting ..... 9-8

F

FM

- FM Antenna, selecting ..... 6-17
- FM radio mode, selection ..... 6-5
- Repeater operation ..... 15-2
- Frequency setting (VFO mode) ..... 5-6
- Frequency offset, setting ..... 15-4
- "FROM" (Access repeater) setting ..... 8-2
  - Using the DR mode scan ..... 8-4
  - Using the preloaded repeater list ..... 8-3
  - Using the Repeater Search function ..... 8-5
  - Using the TX History ..... 8-7
- Front, top and side panels ..... 3-2

G

GPS

- Alarm setting ..... 10-14
- Auto transmission
  - Setting ..... 10-24, 16-47
- GPS Information (Sky view screen), viewing 10-6
- GPS-A
  - Altitude, turning ON/OFF ..... 16-43
  - Comment, programming ..... 16-47
  - Data Extension, setting ..... 16-43
  - D-PRS, description ..... 10-18
  - Symbol, setting ..... 16-44
  - Symbol channel, setting ..... 16-44
  - Symbol list ..... 16-45
  - Setting ..... 10-19
  - SSID ..... 16-46
  - Time Stamp ..... 16-43
  - Transmitting ..... 10-18
  - Unproto Address ..... 16-42
- Grid Locator
  - Changing the Grid Locator ..... 10-4
- Group name programming ..... 10-11
- Indicator, turning ON/OFF ..... 16-33
- Information, viewing ..... 16-34
- Logger function ..... 10-25
  - Turning ON/OFF ..... 10-26, 16-39
  - Operating outline ..... 10-25
  - Record Interval, setting ..... 10-26, 16-39
  - <<GPS Logger Only>> mode ..... 10-29, 16-40

☞ "G" continues on the next page.

INDEX

G

GPS (Continued)

- Manual Position, programming ..... 16-32
- Mapping software, displaying your position ... 10-23
- Memory ..... 10-7, 16-36
  - Adding ..... 10-7
  - Deleting ..... 10-12
  - Editing ..... 10-7
  - Rearrange the display order ..... 10-13
- Message, programming ..... 10-17, 16-42
- Operation ..... 10-2
- Output, turning ON/OFF ..... 16-33
- Position
  - Viewing ..... 10-3, 16-34, 16-35
  - Saving ..... 10-5
- Receiver, selecting ..... 16-32
- Position Format, selecting ..... 16-33
- Power Save (Internal GPS), setting ..... 16-32
- Sentence, setting ..... 10-16, 16-41
- Speed Units, setting ..... 16-33
- Transmitting GPS data ..... 10-16
- TX Mode, setting ..... 16-40
- Viewing the route on a PC Map ..... 10-27

H

- Hand strap ..... 1-3
- HM-75LS remote control speaker microphone 18-4
  - Remote control function setting ..... 18-4
- Home CH Beep function ..... 17-5
  - Operation ..... 17-5
  - Setting ..... 17-5

K

- Key Lock function ..... 5-11

L

- Low-speed data communication ..... 9-14
  - Application setting ..... 9-14
  - Connection ..... 9-14
  - Operation ..... 9-14

M

- MAIN band selection ..... 5-3, 5-13
- Memory bank
  - Assigning a memory channel ..... 12-7
  - Programming ..... 12-8
  - Selection ..... 12-9
  - Setting ..... 12-7
- Memory channel
  - Channel mode selecting ..... 5-8
  - Contents ..... 12-2
  - Copying
    - To another Memory or Call channel ..... 12-6
    - To VFO ..... 12-5
  - Clearing ..... 12-13
  - General description ..... 12-2
  - Name, programming ..... 12-10
    - Selecting display ..... 12-12
  - Programming ..... 12-4
  - Selecting ..... 12-3
- MIC Gain setting ..... 11-19
- Monitor function ..... 5-7, 6-7
- MENU screen ..... 16-2
  - Broadcast (BC) Radio items ..... 16-30
  - Call sign items ..... 16-48
  - Display items ..... 16-72
  - DTMF/T-CALL items ..... 16-61
  - DUP/TONE items ..... 16-16
  - DV Memory items ..... 16-52
  - DV Set items ..... 16-55
  - Entering the Menu screen ..... 16-3
  - Function items ..... 16-65
  - GPS items ..... 16-32
  - Menu items and Default settings ..... 16-4
  - My Station items ..... 16-54
  - QSO/RX Log items ..... 16-62
  - RX History items ..... 16-50
  - Scan items ..... 16-18
  - SD Card items ..... 16-84
  - SPEECH items ..... 16-59
  - Sounds items ..... 16-78
  - Time set items ..... 16-82
  - Voice Memo items ..... 16-22
  - Voice TX items ..... 16-28
- microSD card ..... 2-2
  - Backup to your PC ..... 2-12
  - Folder composition ..... 2-11
  - Inserting ..... 2-3
  - Loading the saved data ..... 2-9
  - Removing ..... 2-4
  - Saving data ..... 2-2, 2-5
  - Saving ..... 2-7
  - Viewing the free space and recordable time 11-22
- MY Call Sign (☎ See 'Call sign')

---

INDEX

N

Name

- Memory/bank/scan, programming ..... 12-10
- Repeater group, programming ..... 9-38
- Transceiver's setting file ..... 2-7
- Scan link, programming ..... 16-21

O

- Off band indication ..... 15-5
- Option list ..... 18-2
  - CHARGERS ..... 18-3
  - CLONING SOFTWARE ..... 18-3
  - BATTERY PACK/CASE ..... 18-3
  - OTHER OPTIONS ..... 18-3
- Operating band selection ..... 5-4
- Operating mode selection ..... 5-7

P

- Playing back (QSO) ..... 11-4, 16-22
- Playing back (Voice Recorder) ..... 11-17, 16-25
- Position Format, setting ..... 16-33
- Power
  - Power ON ..... 5-2
  - Power Save (BC Radio) ..... 6-17
  - Power Save (Internal GPS) ..... 16-32
- Priority watch ..... 14-2
  - DR mode and a priority channel ..... 14-3, 14-13
  - DR mode scan and a priority channel ..... 14-3, 14-16
  - VFO frequency and a Memory/Bank scan ... 14-2, 14-6
  - VFO frequency and a priority channel ... 14-2, 14-4
  - VFO scan and a Memory/Bank scan ..... 14-2, 14-10
  - VFO scan and a priority channel ..... 14-2, 14-8
- Program scan (☞ See 'Scan')
- PTT Auto REC ..... 16-24

Q

QSO recorder

- File
  - Information, viewing ..... 11-14
  - Split, setting ..... 16-24
- Folder
  - Deleting ..... 11-10
  - Information, viewing ..... 11-15
- Pausing ..... 11-6
- Playing back ..... 11-4, 16-22
  - Fast-forward ..... 11-6
  - Playing the next file ..... 11-6
  - Playing the previously file ..... 11-6
  - Pause ..... 11-6
  - Rewind ..... 11-6
  - Operation ..... 11-6
- Recorded audio, deleting ..... 11-9
- Recording a QSO audio ..... 11-2
  - Continue to record (no signals are received) ... 11-11
  - Recording mode, setting ..... 11-5, 16-23
  - Record TX/RX audio into the same file ... 11-12
  - <<REC Start>> ..... 16-22
  - Start to record with [PTT] ..... 11-13
- RX REC Condition, setting ..... 16-23
- Skip time, setting ..... 11-7, 16-24
- Voice Player screen's description ..... 11-8

R

Receiving ..... 5-9

Recording

- Auto Reply audio ..... 9-12, 16-27
- QSO audio ..... 11-2, 11-3, 16-22
- Voice Recorder..... 11-16, 16-24
- Voice TX audio ..... 17-2, 16-28

Record Interval (GPS Logger) ..... 16-39

Repeater

- Checking the repeater input signal ..... 15-3
- Repeater detail screen ..... 9-39
- Repeater group name programming ..... 9-38

Repeater List ..... 9-22, 16-52

- Contents ..... 9-22
- Default values ..... 9-44
- Deleting ..... 9-33
- Editing ..... 9-32
- Programming ..... 9-23
- Rearrange the display order ..... 9-34
- Updating ..... 2-13

RX Bass ..... 16-55

RX Bass Boost ..... 16-55

RX Call Sign Write ..... 16-57

RX History ..... 16-50

- Adding the Repeater information ..... 9-35
- Received call sign viewing ..... 9-5
- View in the RX History screen ..... 9-5

RX REC Condition ..... 16-23

RX Repeater Write ..... 16-57

RX Treble ..... 16-55

S

Scan

- Bank Link setting ..... 16-19
- Description ..... 13-2
- During Dualwatch operation, description ... 13-4
- Link channel, deleting ..... 16-21
- Memory bank scan
  - Description ..... 13-2
  - Operation ..... 13-10
- Memory scan
  - Description ..... 13-2
  - Operation ..... 13-9
- Pause Timer, setting ..... 16-18
- Program Link, adding ..... 16-20
- Program scan link name programming ..... 16-21
- Program Skip, turning ON/OFF ..... 16-19
- Receive mode, description ..... 13-3
- Resume Timer, setting ..... 16-18
- Scan name, description ..... 13-4
- Scanning direction, description ..... 13-3
- Scan Stop Beep function, description ..... 13-4
- Skip function, description ..... 13-3
  - Skip frequencies setting ..... 13-7
  - Clearing the skip setting ..... 13-8
  - Skip channel setting ..... 13-12
- Squelch setting ..... 13-3
- VFO scan
  - Description ..... 13-2
  - Operation ..... 13-5
  - When a signal is received ..... 13-4

Speech function ..... 9-15, 17-6

- [DIAL] speech function ..... 17-6
- Mode speech function ..... 17-7
- Language selection ..... 9-17
- Level selection ..... 9-18
- Phonetic Code setting ..... 9-17
- Received call sign announcement ..... 9-15
- RX>CS call sign announcement ..... 9-16
- Speed selection ..... 9-18

Squelch

- Level setting ..... 5-6
- Level setting (BC Radio) ..... 6-7
- Level setting (Scan) ..... 13-3

Volume setting for Dualwatch ..... 5-14

SJ-1 silicone jacket ..... 18-8

Skip

- Channel setting ..... 13-12
- Setting for the BC radio memory ..... 6-15
- Setting for the DR mode scan ..... 9-36
- Skip function ..... 13-3
- Skip Time, setting ..... 16-24

Speed Units, setting ..... 16-33

SSID, selecting ..... 16-46

Sweep operation ..... 5-12

---

INDEX

T

Transmit power levels ..... 5-10

Temporary skip function ..... 13-13

    Temporary Skip timer ..... 13-3

Time Stamp ..... 16-43

“TO” (Destination) setting ..... 8-8

    Directly inputting (RPT) ..... 8-15

    Directly inputting (UR) ..... 8-14

    Using the RX History ..... 8-12

    Using the TX History ..... 8-13

    Using the “Your Call Sign” ..... 8-11

    Using the “Gateway CQ” (Gateway call) ... 8-10

    Using the “Local CQ” (Local Area call) ..... 8-9

Tone Burst ..... 16-17

Tone squelch

    Frequency, setting ..... 17-13

    Operation ..... 17-13

Transmitting (VFO) ..... 5-10

Transmitting GPS-A data ..... 10-18

Transmitting GPS data ..... 10-16

Troubleshooting ..... 20-1

    Others ..... 20-3

    While operating D-STAR ..... 20-1

    While operating GPS Logger ..... 20-2

Tuning step

    Tuning step for a VFO scan ..... 13-3

    Tuning step selection ..... 5-5

    Tuning step (AM Only) setting ..... 6-8

TX Bass ..... 16-55

TX Message ..... 16-54

TX message deleting ..... 9-4

TX Monitor function ..... 17-4

TX Treble ..... 16-55

U

Unproto Address ..... 16-42

V

VFO mode ..... 5-8

Voice TX function ..... 17-2

    Play Files ..... 16-29

    Recording ..... 17-2

    Repeat Time setting ..... 17-4

    The recorded voice audio playing back ..... 17-2

    Transmit ..... 17-3

Voice Recorder function ..... 11-16

    Changing the skip time ..... 11-20

    Erasing the recorded contents (audio) ..... 11-18

    Play Files ..... 16-25

    Playing back ..... 11-17

    Playing back on a PC ..... 11-23

    Viewing the file information ..... 11-21

VOX function ..... 18-5

    Headset, selecting type ..... 18-5

    Turning ON or OFF ..... 18-6

    VOX gain, setting ..... 18-7

    VOX-related settings ..... 18-8

W

Weather alert function ..... 5-15

    Operation ..... 5-15

    Channel selection ..... 5-15

Y

Your Call Sign ..... 16-52

    Your (destination) call sign programming ... 9-40

Your setting is correct? ..... 9-45

**Count on us!**

